

VOLKSWAGEN

TRANSPORTER

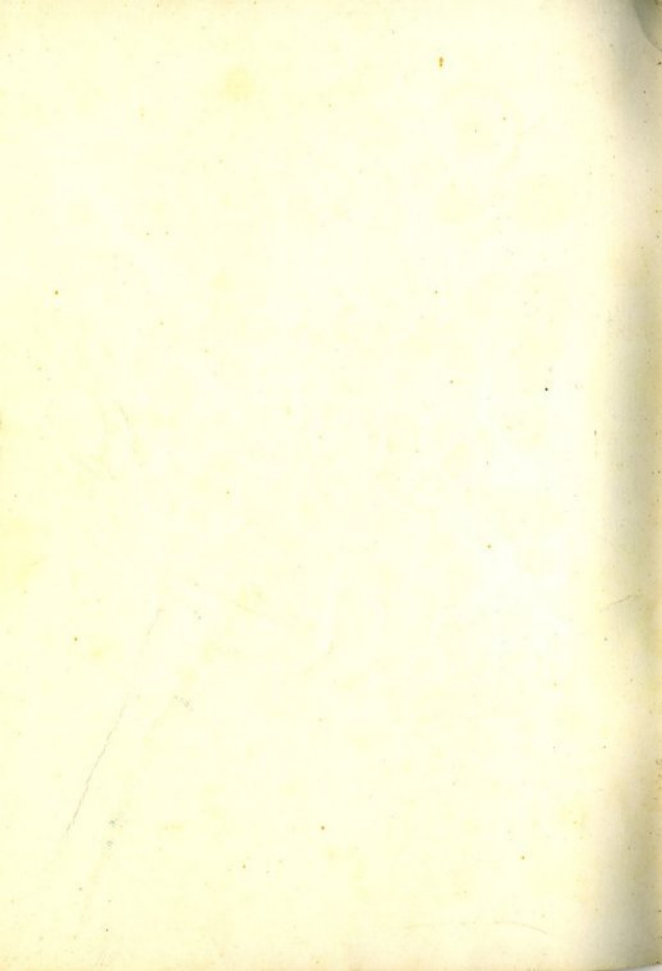



VOLKSWAGEN

TRANSPORTER

INSTRUCTION MANUAL

November 1963 Edition

VOLKSWAGENWERK AG WOLFSBURG
Germany



C O N T E N T S

Controls and instruments	3
Operating instructions	7
Practical driving	21
Cold weather hints	26
Lubrication	29
Care of tires	38
Care of vehicle	40
Maintenance	44
General description	63
Technical Data	67
Bulb chart	73
Lubrication chart	75
Maintenance chart	76
Index	77
Tools and accessories	inside back cover

If you want to learn the most important information about your Volkswagen Transporter quickly, please read the first three sections:

Controls and instruments	Page 3
Operating instructions	Page 7
Practical driving	Page 21

This manual is valid for the 1200 and 1500 Transporter. All 1500 Transporter technical detail which differs is printed in blue.

CONTROLS AND INSTRUMENTS

The first thing you must do is become familiar with the controls and instruments of your new VW Transporter. Sit behind the wheel, make yourself comfortable, and get acquainted with all the various levers, switches and controls. Some of the features you may already know. Check your present knowledge against this complete list.

THE VEHICLE KEYS

Only one key is required for the locks in the vehicle doors and rear panel and to operate the starter-ignition lock (29). If your vehicle is equipped with a steering-ignition lock you will receive a second key. It is advisable to make a note of the key number and keep it with the vehicle documents. If a key is lost, you can then quote the number when ordering a replacement from your VW Dealer.

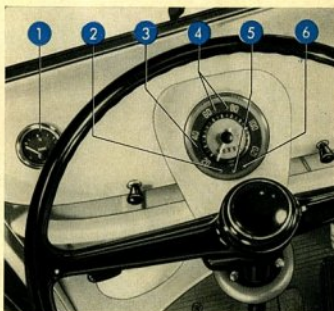

INSTRUMENTS:

- 1 - Fuel gauge
- 2 - Warning light - Red - Generator and cooling
- 3 - Speedometer and mileage recorder
- 4 - Warning light - Green - Flashing indicators
- 5 - Warning light - Blue - Headlight high beam
- 6 - Warning light - Green - Oil pressure

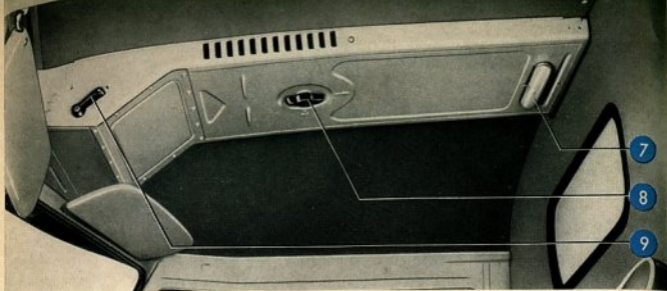

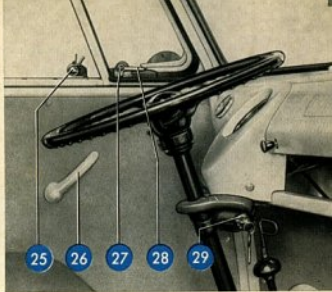

- 7 - Switch for cab lighting
- 8 - Fresh air distributor
- 9 - Fresh air regulator lever
- 10 - Steering wheel
- 11 - Horn button
- 12 - Lighting switch and instrument light control
- 13 - Windshield wiper switch
- 14 - Turn indicator switch
- 15 - Switch for load compartment light
- 16 - Gear lever
- 17 - Warm air control
- 18 - Hand brake
- 19 - Square key
- 20 - Accelerator
- 21 - Brake pedal
- 22 - Clutch pedal
- 23 - Dimmer switch
- 24 - Heating control knob
- 25 - Door window fastener
- 26 - Inside door handle
- 27 - Vent wing lock button
- 28 - Vent wing fastener
- 29 - Ignition/starter switch

Among the papers which come with your vehicle you will find details regarding the model, year of construction, and chassis and engine numbers. The Police or Traffic Department may check whether or not the information on the papers corresponds exactly with that on your vehicle.

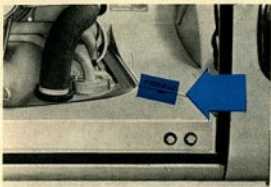

THE CHASSIS NUMBER

is stamped on the engine cover plate near the battery.

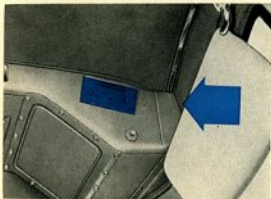

THE IDENTIFICATION PLATE

is on the right hand side of the air duct in the cab.

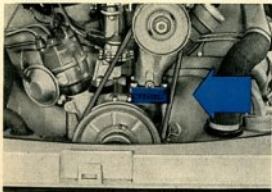

THE ENGINE NUMBER

is on the crankcase flange for the generator support.



OPERATING INSTRUCTIONS

BEFORE YOU DRIVE AWAY
please check

- engine oil level
- fan belt tension
- quantity of fuel in the tank
- tire pressures
- efficiency of brakes
- position of rear view mirror

and, if driving at night
or in foggy weather,

- the exterior lights

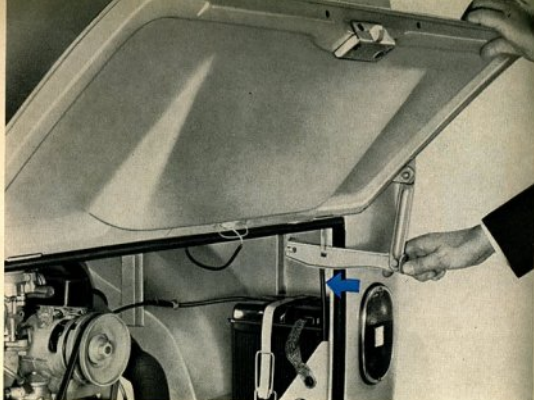

The engine compartment lid is opened with the square key which is located in a holder in the cab near the left headlamp housing. The lid can be lowered by pressing against the horizontal bar of the check mechanism.

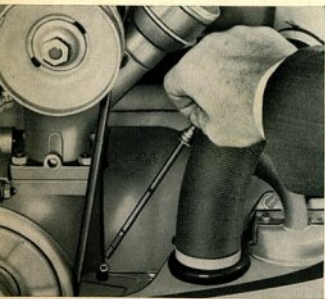

ENGINE OIL LEVEL

The oil level can only be checked with the engine at rest. The oil level is satisfactory when it is between the two marks on the oil level dipstick, but **it should never be permitted to drop below the lower mark.** To make an accurate check, it is best to wipe the dipstick with a clean rag beforehand.

Should it become necessary to top up, please remember the following hints: Most oils marketed at present contain chemical ingredients to improve their lubricating qualities. However, oils of

different origin behave differently when used as engine lubricants and should, therefore, not be mixed.

Select an HD oil of a well-known and dependable brand right at the beginning and stick to it.

Further hints regarding engine oil changes are given in the sections "Cold Weather Hints" and "Lubrication" on pages 28 and 30—33.

FAN BELT

The V-belt drives the generator and the fan. **Perfect condition and correct tension ensures long belt life and adequate engine cooling.** Checking is very simple: when pressed with the finger, the belt must yield **approximately 15 mm. (.6").** If you find any sign of wear, such as frayed edges, see your VW Dealer. Although the belt has a long service life, always carry a spare on the vehicle. Details are given on page 46.

a = 15 mm. (.6")

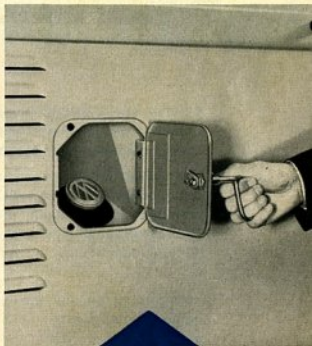
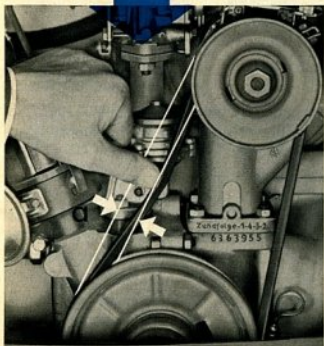

FUEL TANK

The tank has a capacity of 40 liters (10.6 U.S. gals., 8.8 Imp. gals.), which is sufficient for a distance of about 400 kilometers (250 miles).

The tank filler neck on the right-hand side of the vehicle is accessible after opening the cover with the square key delivered with the vehicle.

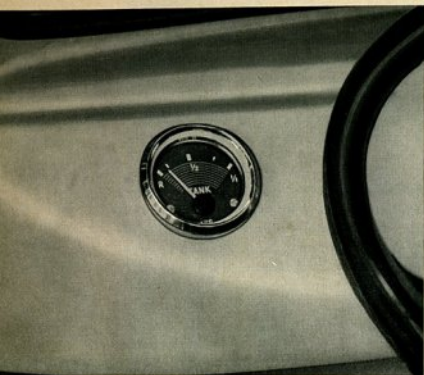

The fuel gauge shows the amount of fuel in the tank. When the needle is on "R" (Reserve) it is time to refuel at the next opportunity. The 5 liters remaining in the tank will last for about 50 km. (30 miles).

The choice of fuel type and brand is left entirely to you. The VW engine is so designed that it will run satisfactorily on all normal reputable fuels. All good brands, including regular and premium mixtures, are distinguished by their consistent composition adequate anti-knock properties and freedom from harmful ingredients.

THE TIRES

deserve and require your particular attention. A special section deals with the care of the tires on pages 39—40. The riding comfort and the roadholding of your Transporter will greatly depend on their condition. Maintaining correct tire pressure and avoiding driving abuses are the most important factors in obtaining maximum tire life. Check regularly and keep tires inflated to the following pressures:

Rear:

Up to $\frac{3}{4}$ payload 2.3 kg./cm². (33 psi.)

With full load . . . 2.5 kg./cm². (36 psi.)

Spare wheel 2.5 kg./cm².

Front 2.0 kg./cm². (28 psi.)

Ambulance

Front and Rear 1.8 kg./cm².
(26 psi.)

The tire pressures on the 1 Ton Transporter are as follows:

Front 2.0 kg./cm². (28 psi).

Rear:

Up to $\frac{3}{4}$ payload 2.3 kg./cm². (33 psi.)

With full load . . . 2.8 kg./cm². (40 psi.)

Spare wheel 2.8 kg./cm². (40 psi.)

Do not forget to replace the valve dust caps.



THE BRAKES

should be checked while the vehicle is in motion before starting out on a trip to make sure they are in good working order. The section "Apply the Brakes Gently" on page 17 deals with the correct application of brakes under various circumstances.

GOOD EXTERIOR LIGHTS

are the first requirement of safe night driving. The three positions of the light switch are the following:

- Fully pushed in — Off.
- Pulled out to first stop — Parking light, tail and license plate lights.
- Fully pulled out — Headlight high or low beams (depending on position of foot dimmer switch), tail and license plate lights.

When the lighting switch knob is pulled out to either the first or second stop, the instrument light is automatically turned on. By turning the knob a variable degree of instrument lighting is obtained; turning the knob to extreme left turns out the light entirely. When checking the lighting system, do not forget the two stop lights which should light up when depressing the brake pedal with the ignition turned on.

STARTING THE ENGINE

The ignition and starter are switched on, one after the other, by means of the combined starter-ignition switch. As starter operation stresses the battery heavily, other big current users, such as the headlights windshield wiper and radio, should not be switched on when starting. Make sure, also, that the gear shift lever is in neutral.



First switch on the ignition by turning the key to the right until the red and green warning lights in the speedometer come on. Then operate the starter without delay by turning the key further to the right.

At temperatures above freezing point or when the engine is still warm, depress the accelerator pedal slightly while operating the starter. Only when the engine is very warm should the accelerator be fully depressed.

At temperatures below freezing point and when the engine is cold, depress the accelerator pedal fully and then release it before switching on the ignition. This enables the automatic choke device to close the choke valve. As the engine and transmission oils tend to become thick when cold, you should

also declutch when starting so that the starter motor only has to turn the engine. As soon as the engine starts, release the ignition key so that the starter is switched off. You can then drive off straight away as the choke valve opens automatically as the engine warms up and regulates the idling speed to suit the engine temperature. Do not race the engine when it is completely cold. If the engine does not start within the first 10 seconds, pause for about the same length of time to rest the battery before repeating the starter operation. The ignition will have to be switched off first and then on again as a non-repeat lock in the switch prevents the starter from being operated repeatedly when the ignition is on and thus being damaged by the engine when it is running. The starting procedure should not be interrupted if the engine is heard to fire a few times without starting.

If your vehicle has a steering-ignition lock, the engine is started in the same manner.

Caution

Be careful when starting the engine inside your garage. Keep the door and windows open so that the exhaust fumes can escape. These contain deadly carbon monoxide which is a colorless, tasteless and odorless gas.

MOVING OFF

is extremely easy, if you observe the following:

- 1 - Depress the clutch pedal as far as possible. Keep it in that position.**
- 2 - Shift to the first gear. Release the hand brake.**
- 3 - Engage the clutch by allowing the pedal to return slowly, and simultaneously depress the accelerator pedal. The vehicle will start to move forward.**
- 4 - Gradually increase the pressure on the accelerator pedal and remove your foot completely from the clutch pedal, as the clutch is now fully engaged.**

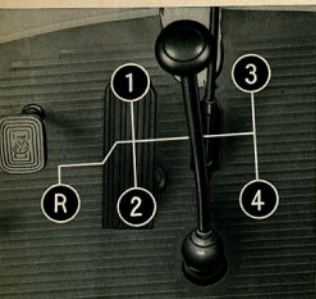

Shifting to second gear is equally simple:

- 1 - Take your foot off the accelerator pedal, simultaneously depressing the clutch pedal.
- 2 - Shift gear lever into second position.
- 3 - Engage the clutch gently by gradually taking your foot off the pedal, and at the same time depressing the accelerator pedal.

You now know how to "shift gears", and may at will shift to third and fourth positions. As you have noticed the accelerator and clutch pedals are operated simultaneously, but in opposite directions. It is the coordination of these operations that brings skill in shifting gears.

THE REVERSE GEAR

should never be engaged unless the vehicle is at a standstill. To engage the reverse gear, first press down the gear lever vertically, move it to the left and pull it rearwards.

SHIFTING TO A LOWER GEAR

This is what you should do in dense city traffic, or with sharp turns ahead of you, or when driving up-hill.

- 1 - Release accelerator pedal and depress clutch pedal.
- 2 - Shift to 3rd, 2nd or 1st gear respectively.
- 3 - Release clutch pedal and depress accelerator pedal simultaneously.

Of course, this takes less time to do than it does to describe. We do not want to bore you with a technical discourse, but it may be of interest to you to know that, when shifting down, the synchromesh device ensures meshing of the gears without clash, as the lower gear is synchronized so that both gears are turning at the same speed.

To ensure correct synchromesh operation, it is essential that the clutch is fully disengaged when shifting gears. If the clutch pedal is only partially depressed, the gears will be difficult to engage and the synchromesh units will wear prematurely.

To avoid undue strain on transmission and engine, shifting down should only be effected within the speed range of the lower gear i. e.

1200 Transporter

from 4th into 3rd gear between 65 and 30 kph (40 and 20 mph) and from 3rd into 2nd gear between 40 and 20 kph (25 and 12 mph).

1500 Transporter

between 75 and 30 kph (40 and 20 mph)
between 45 and 20 kph (27 and 12 mph)

The 1st gear is only used for moving off, driving at walking pace, or on very steep inclines.

After a short period of practice, you will take pleasure in shifting the gears properly and obtain the utmost satisfaction from the efficient performance of your new Transporter. Under no circumstances should you be afraid to shift to a lower gear, or even try to avoid shifting occasionally by merely "slipping" (partly disengaging) the clutch.

Do not use clutch pedal as a foot-rest while driving your vehicle.

APPLY THE BRAKES GENTLY

The brake responds to even the slightest foot pressure. Increasing the pressure will slow the vehicle down progressively. However, avoid locking the wheels. Locked wheels will not shorten the braking distance but may cause you to lose control over the movement of the vehicle and will affect the tires adversely.

Here are a few rules on braking:

Use your brakes **before**, not **while** making a turn.

It is neither practical nor economical to shift to a lower gear far ahead of a turn. Do not hesitate to use the brakes and to shift shortly before entering a curve so that you may accelerate while still negotiating it.

To jam on the brakes suddenly can only be justified when danger is ahead. Nevertheless, it is advisable to check the full braking efficiency from time to time to familiarize yourself with the reaction of the vehicle and with the actual stopping distance. Never forget to look in the rear view mirror to make sure

that you will not endanger any vehicle that might be following you. Operate your brakes especially gently when the road is wet or covered with ice as locked wheels will result in skidding.

When driving downhill, make use of the braking capacity of the engine compression by shifting to the gear which you would use in driving up-hill. You will attain a higher degree of safety and at the same time you will save and preserve the brakes if you use them only to control the speed occasionally. The ignition must never be switched off when going downhill.

STOPPING THE VEHICLE

Take your foot off the accelerator pedal and apply the brakes gently. Shortly before the vehicle comes to a full stop, depress the clutch pedal and place the gear lever in neutral. The engine continues to idle.

If you wish to switch off the engine, merely turn the ignition key to the left.

On vehicles with the steering-ignition lock, it is important to remember not to withdraw the ignition key until the vehicle is stationary as the steering is locked when the key is in the "Halt" position.

MISTED WINDOWS

will greatly reduce visibility. This is brought about by the humidity from the passengers' breath in the car and a low outside temperature. By using the vent windows intelligently sufficient fresh air can be provided while the used air is sucked out. Not only will the windows remain clear but so will your head.

THE CAB SEATS

are divided into an adjustable driver's seat and a seat bench. The driver's seat can be adjusted longitudinally, even when the vehicle is in motion, by lifting the adjusting lever and sliding the seat forward or backward until the best position is obtained. After adjusting, ensure that the lever engages properly so that the seat does not slide unintentionally while driving.

The angle of the back rest can be altered by turning the two adjusting screws.

The seat bench can be tipped forward and taken out easily.

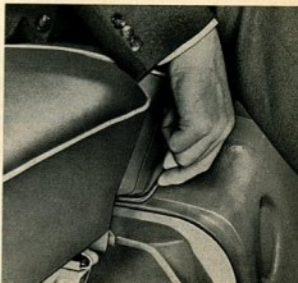
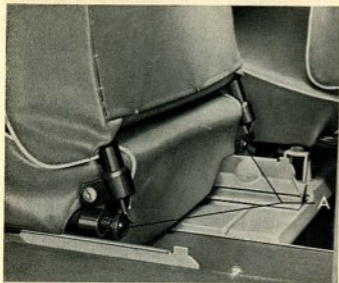

A — Adjusting screws

Sitting and driving for long periods places a certain amount of strain on the human body. It is, therefore, important to adjust the seat correctly to your individual requirements, and so avoid unnecessary fatigue.

THE REAR VIEW MIRROR

can be adjusted from the driver's seat to suit individual requirements. Set it so that you can see the entire width of the road behind the vehicle for a great distance without turning the head or the upper part of the body.

THE SUN VISORS

can be swivelled towards the door windows to give protection against dazzle from the side.



THE INTERIOR LIGHT

of the cab is operated by a switch built into the lamp.

The light in the loading compartment or passenger compartment is operated by the tumbler switch situated on the left hand side of the instrument panel below the speedometer.

THE WINDSHIELD WIPERS

operate when the knob on the left of the speedometer is pulled out.

The wiper blades should be removed occasionally and cleaned thoroughly with a hard brush and methylated spirits or a strong detergent solution. Particularly during long dry periods they tend to become clogged with tar splashes and insects. The blades should be renewed once a year.

VENTILATION

Of the cab and loading compartment takes place via a duct on the roof panel when the vehicle is moving. The amount of air admitted can be regulated by moving the lever on the left side of the duct to one of three positions. In the rear position the duct is closed completely.

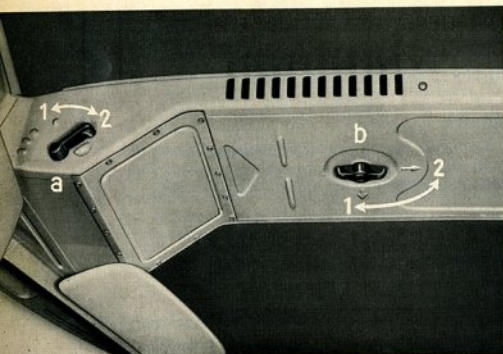

a - Fresh air regulator lever

1 - On
2 - Off

b - Fresh air distribution

1 - Cab
2 - Loading compartment or passenger compartment

The fresh air can be distributed to cab or loading compartment by means of the lever below the duct. When set across the duct, the air is directed to the cab and when set lengthwise the loading or passenger compartment is ventilated. When the lever is set between the end positions, air is directed to both parts.



THE SUN ROOF

is free to slide when the locking lever is turned to the left. It may be fixed in any desired position by merely twisting the lever to the right. It is good practice, however, to open the roof fully prior to sliding it to the desired position. This will not only make the opened roof look better, but will also fold the material properly.

To close the sliding roof, turn the handle to the left first, then pull the roof forwards until the locking hook engages and turn handle to the right.

If you have a Pick-up, note the following: When the tarpaulin is wet from rain or washing, always let it dry on the vehicle to avoid shrinkage.

SLIDING DOOR

If your Transporter has a sliding door instead of the normal wing door, note the following instructions:

To open the door, press the handle down. The door slides back easily and is held open by a lever.

To close the door, press the handle down and slide the door forwards firmly until it engages. Then pull the handle up so that the rear edge of the door contacts the body properly.

The door can be locked to prevent pilfering.

Please remember that the sliding door must always be closed when the vehicle is in motion.

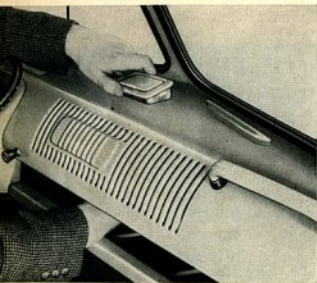

THE ASH TRAY

in the instrument panel can be easily removed by pushing it upward from below the panel.

The ash trays in the passenger compartment of the VW Micro Bus are pulled up for removal.

PRACTICAL DRIVING



BREAKING-IN INSTRUCTIONS

are not necessary for the Transporter. The most modern production and inspection methods have made it possible to dispense with the initial speed restrictions which are normally required. You can drive the vehicle at full speed from the first day.

It is advisable, however, to observe certain fundamental driving rules at all times. You can influence the performance and service life of your vehicle considerably by doing this.

Always keep the vehicle speed within the permissible ranges for the various gears.

1200 TRANSPORTER

- 1st gear 0—20 kph (0—12 mph)
- 2nd gear 10—40 kph (6—25 mph)
- 3rd gear 20—65 kph (12—40 mph)
- Top gear 30—95 kph (20—60 mph)

1500 $\frac{3}{4}$ Ton TRANSPORTER

- 1st 0— 25 kph (0—15 mph)
- 2nd 10— 45 kph (6—28 mph)
- 3rd 20— 75 kph (12—46 mph)
- 4th 30—105 kph (20—65 mph)

1500 / 1 Ton TRANSPORTER

- 0— 20 kph (0—12 mph)
- 10— 40 kph (6—25 mph)
- 20— 70 kph (12—43 mph)
- 30—105 kph (20—65 mph)

So do not rev the engine too high in neutral nor when driving in the individual gears.

On the other hand, do not labor the engine by driving too slowly in the gears.

Always change down in good time on gradients and keep the engine at the most favorable rpm.

ECONOMICAL OPERATION

is one of the outstanding features of your vehicle. However, getting a few extra miles from each gallon depends on the manner in which you handle your vehicle and use the gears.

When accelerating,

depress the accelerator pedal slowly and only to such an extent as is necessary to reach the desired speed. Depressing the accelerator pedal rapidly does not improve acceleration, but results in an increased fuel consumption.

Do not "pump" the accelerator pedal

unless circumstances require it. Even the small quantity of fuel additionally discharged by the accelerator pump each time the accelerator pedal is depressed results in a marked increase in the overall fuel consumption.

Drive your vehicle smoothly and to suit the circumstances

both when in city traffic and on main roads. Adapt the speed of the vehicle to prevailing road and traffic conditions. A good driver accelerates gradually, slows down in time, and utilizes the braking power of the engine. Make use of the full acceleration capacity and the excellent brakes of your Transporter only when you really need to.

HOW TO DRIVE AT HIGH SPEED WITHOUT SACRIFICING FUEL ECONOMY

When you have accelerated to the desired speed, slowly let the accelerator pedal return to the position which just maintains this speed. This practice is especially economical when driving on highways. If you attach particular importance to economy and also to a fair average speed, you will be well advised to select a suitable cruising speed in the most efficient range of consumption.

The most economical speed in fourth gear is between 40—70 kph (25—43 mph) on the 1200 Transporter, and 40—85 kph (25—52 mph) on the 1500 Transporter.

The fuel consumption does not go up equally with the speed; it increases more rapidly at higher speeds. Perhaps you are aware of the fact that air resistance is an obstacle for all vehicles particularly at high speeds. Due to the simple lines of your Transporter, the air resistance is relatively low, but it should be remembered that high road speed always involves a greater fuel consumption.

WATCH THE ROAD

closely while driving. You should now be able to operate the various levers, switches and controls automatically. Furthermore, your Transporter will "tell" you on its own accord when it needs attention.

FLASHING INDICATORS Green Arrows

The direction indicators lie outside the driver's vision. However, the green indicator light shows when they are in operation. The direction indicator switch can be operated without taking the hand off the steering wheel.

OIL PRESSURE Green Light

The oil pressure of your vehicle is as important as the oil level. When the ignition is turned on, the green oil pressure light will go on. The light should go out when the engine is started and the oil pressure increases.

IMPORTANT If the green light goes on when the engine is running, the chances are that the oil circulation has been interrupted, which means that the lubrication of the engine has ceased. Stop at once and check the level of the oil before you consult a Service Station. If the lamp flashes occasionally when the engine is warm and running slowly it does not indicate trouble if it goes out again as the speed increases.

GENERATOR AND COOLING Red Light

are controlled simultaneously by a red light. The light will show when the ignition is turned on and when the engine is running at low speed. The light should go out as speed is increased.

WARNING If the red light goes on while you are driving the vehicle, the fan belt may be broken. Stop and find out what is wrong, for if the belt is broken, the cooling is disrupted and the generator no longer charges.

HEADLIGHTS Blue Light

The high beam of your headlights can be blinding to oncoming drivers. You know yourself how unpleasant and dangerous this is. For this reason, be considerate. The blue light will tell you when the high beam is switched on. Just depress the dimmer switch to transfer the headlights from high to low beam.

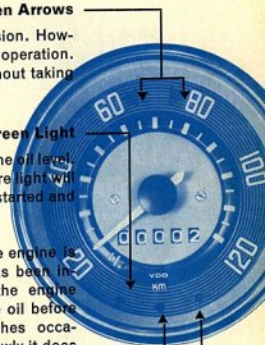

SPEED

You may often under-estimate the speed of your Transporter at first. Special attention should be paid, therefore, to the speedometer during the initial driving period.

SAFETY FIRST

Safety for yourself, and safety for others, this is what counts most. Your Transporter is a vehicle with unequalled road holding, cornering stability and acceleration. Do not allow the feeling of security and safety which you will acquire after a few miles to make you careless.

Therefore, adjust the speed of your Transporter to the conditions of road, traffic and weather, and always be ready to bring it to a stop when it is necessary. Be particularly careful when driving on wet or icy roads, for even a Transporter is apt to skid when not driven carefully under such conditions.

PASSING OTHER VEHICLES

Pass other vehicles with consideration. Always be sure that the road is clear ahead of you, and look out for vehicles approaching you from the opposite direction. A brief look in your rear view mirror will tell you whether another vehicle is about to pass you from behind. If you have to shift to a lower gear, do it before, not while, passing other vehicles.

And here is another warning: Never try to overtake when approaching a curve, where vision is not clear, and never overtake at the crest of a hill or at crossroads. You never can tell what lies ahead of you.

Be fair and do not accelerate when another car tries to pass you. You will endanger your life and those of others.

STOPPING YOUR TRANSPORTER TEMPORARILY

When stopped at an obstruction, a traffic light or railroad crossing, do not wait with the clutch pedal pressed down and the gear engaged. Shift to first gear shortly before moving on again, it will preserve the clutch.

PARKING YOUR TRANSPORTER

in a space between two vehicles parked at the curb can be easier if you heed the following advice:

Stop your vehicle level with the vehicle in front of the space. Turn the steering wheel sharply to the right and back your vehicle slowly into the gap.



When the front bumper of your Transporter is even with the rear bumper of the vehicle ahead of you, turn the steering wheel fully to the left, and back up further toward the curb.



Now turn the steering wheel to the right again and pull up a little bit, until both ends of the vehicle come as close to the curb as possible.



When parking on a steep gradient, set the hand brake to stop the vehicle rolling. As a precautionary measure, it is advisable to engage first or reverse gear in addition to the hand brake. And do not forget to take the key out of the ignition switch before you leave your vehicle. If a steering-ignition lock is fitted, remove the key at the "Halt" position. This locks the steering and protects the vehicle against theft.

Prior to locking the driver's door secure the door on the other side by lowering the inside door handle.

It is advisable to lock the door windows when leaving the vehicle for any length of time.

COLD WEATHER HINTS

IN WINTER

you will greatly appreciate the air cooling and the heating of your vehicle. You may leave your car out in the bitter cold without fear. The air-cooled engine will always start readily and will heat up the interior of the car quickly and uniformly.

THE WARM AIR HEATING

can be regulated by a rotary knob situated at the right-hand side under the seat:

- Anti-clockwise — On (1)
- Clockwise — Off (2)

Warm air to the defroster nozzles and to the feet is further controlled by the distributor in front of the hand brake lever. Heating efficiency can be considerably increased by opening a vent window so that the blower can force the warm air more easily into the otherwise well sealed interior.

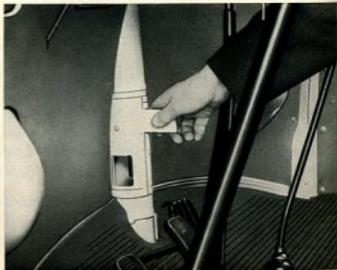

ENGINE OIL

Viscosity grade SAE 20 W/20 for the 1200 Transporter and SAE 30 for the 1500 Transporter and the 1 Tonner is specified for temperatures over freezing point. If, however, atmospheric temperatures below freezing point are anticipated the use of SAE 10W is recommended. This grade of oil may remain in the engine with safety when the temperature again rises to a higher range. Should it become necessary to add oil in the period between two regular oil changes, SAE 10W oil may be used during lasting frost and an oil with a higher SAE grading when the average temperature rises. This means that the different SAE grades can be mixed without detriment, but be sure to use always the same brand and type of engine oil.

The engine does not need to be warmed up before moving off, but it is advisable not to race the engine immediately after starting when the temperature is low.

Only if your VW Transporter is mainly operated for short distances **during cold weather** is it advisable to have the oil changed at more frequent intervals, say every 2500 km. (1500 miles), using the prescribed HD oil. In the warmer season, oil changes in addition to those laid down in the Lubrication Chart are unnecessary and uneconomical.

In territories with **arctic climates**, it is advisable to use SAE 5 W oil when the temperature is very low (approx. $-25^{\circ}\text{C}/-13^{\circ}\text{F}$). This oil should be changed every 1250 km. (750 miles) and the strainer cleaned at the same time.

TRANSMISSION OIL

The SAE 90 oil can generally be used all the year round. It need only be replaced by the thinner SAE 80 grade in countries with arctic climates.

THE CHASSIS

is particularly exposed to the cold and wet weather in winter. You are therefore strongly advised to adhere strictly to our instructions for lubrication. If, in addition, you spray the bottom of the vehicle with a suitable anti-corrosion oil, as a protection against rusting, you will prolong the life of your Transporter.

THE BRAKES

of all automobiles are more or less exposed to splashing water which in winter is apt to freeze in the brake drums. Therefore, when parking your vehicle, do not set the hand brake but shift to first or to reverse gear.

THE DOOR LOCKS

can freeze up in the winter, especially if water gets into the lock cylinder when washing the vehicle. You should, therefore, not aim the water jet directly at the lock, or better still, cover the key hole up when washing. A frozen lock can be opened by warming the key before insertion and then squirting anti-freeze into the lock cylinder straight away.

TIRES

Worn tires are apt to cause trouble in winter. For safety's sake replace them in time. To meet the special requirements in winter, so-called **M+S** tires are available. These special-tread tires are designed to give a better grip on mud and snow. They are either used on the rear wheels only or on all four wheels. However, during the rest of the year you should use the usual tires.

CHAINS

You will need chains only when the roads are covered with snow. Without such chains the rear wheels of your vehicle are apt to spin, and applying the brakes may result in skidding. Have the chains adjusted to the wheels if you wish to avoid loss of time and inconvenience later on. When driving on long stretches that are free from snow, the chains should be removed to avoid unnecessary wear of both chains and tires.

THE BATTERY

is under greater strain in winter than in warmer seasons because of the increased consumption of current when starting the engine and using the lights at night. Besides this it is a characteristic feature of any battery that its efficiency decreases at lower temperatures. If the vehicle is used mostly over short distances, the battery may require additional recharging.

Keep the battery well maintained and the ground cables and connections between battery and starter clean.

SPARK PLUGS

The normal gap is 0.7 mm. (.028"). In extremely cold weather, reduction of the gaps to 0.4—0.5 mm. (.016"—.020") will aid cold starting considerably.



LUBRICATION

PROPER LUBRICATION IS OF VITAL IMPORTANCE TO YOUR TRANSPORTER

The extra time spent in following these recommendations will be amply rewarded in the long run by your vehicle's efficient performance. It is up to you to maintain the standard of safety offered by your VW Transporter, and to ensure the long life and good service which you have the right to expect from this truly economical vehicle.

TO LUBRICATE CORRECTLY MEANS TO LUBRICATE CAREFULLY AND AT THE PRESCRIBED INTERVALS

Therefore, do not shy at the work connected with regular lubrication. A Lubrication Chart can be found on page 75, indicating the correct mileages at which to lubricate. The Service Booklet makes it possible for you to have your Transporter lubricated in an authorized workshop by skilled hands, at lowest cost and in a minimum of time. You really cannot afford to miss this opportunity.

ENGINE OIL CHANGE

Regular oil changes are necessary even if the very best branded oils are used. Diluted and dirty oil in your engine simply means increased wear and a shorter life for your engine. On the other hand, provided that HD oil is

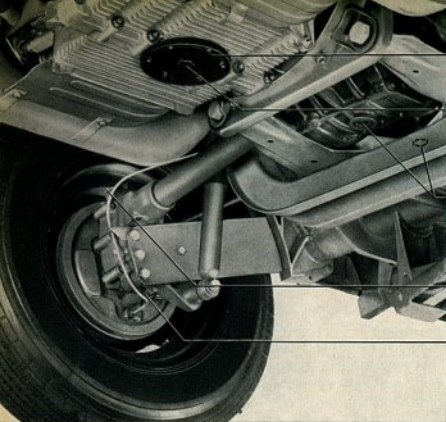

Oil Strainer
with cover

Oil Drain Plug
for crankcase

**Magnetic Oil
Drain Plugs**
for rear axle and
transmission

Oil Filler Plug

Oil Drain Plug
for reduction gears
at rear wheels

used, it is unnecessary and uneconomical to change the oil more frequently than called for in the Lubrication Chart.

The old oil is drained when warm by removing the plug in the oil strainer plate. The engine need not be flushed but the strainer must be removed at

- 1 - Gasket
- 2 - Oil strainer
- 3 - Gasket
- 4 - Bottom plate
- 5 - Oil drain plug and seal
- 6 - Nut and spring washer

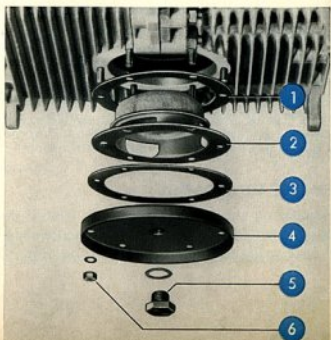



each oil change and cleaned thoroughly. Both gaskets should be renewed. The engine is then filled with 2.5 liters of HD oil (5.3 U.S. pints; 4.4 Imp. pints).

TYPES OF LUBRICANT

There are good reasons for using a

branded HD oil

in your engine.

HD oils have proved oxidation stability, bearing corrosion preventive properties and detergent-dispersant characteristics which tend to hold in suspension foreign contaminants which would normally settle on engine parts. These foreign contaminants will drain out with the oil at the periodical oil changes. The detergent properties of HD oil will make the fresh oil darker after a short period of use. This is quite natural and there is no reason whatsoever to change the oil earlier than called for in the Lubrication Chart.

SOME MORE INFORMATION ON ENGINE OILS

It is left to your discretion to select an oil of a well-known and dependable brand of the proper viscosity to suit seasonal and driving requirements. In cases of doubt, refer to your authorized VW Dealer who will be glad to help you with your lubrication problems. It is recommended that you select "your" oil right at the beginning and stick to it at all future service oil changes.

The requirements of the VW engine are met by all approved commercial brand oils. Viscosity of the lubricant is an indication of its resistance to flow at a given temperature. The SAE numbers classify lubricants in terms of viscosity, for example: SAE 20 W/20, SAE 10 W etc. The selection of the SAE grade to be used is based on the outside air temperature.

1200 Transporter

SAE 30 This oil is satisfactory in tropical climates where the temperature will frequently rise above 30° C (86° F).

SAE 20 W/20 engine oil is suitable for temperatures from 30° C to 0° C (86° F to 32° F).

For 1500 Transporter and 1 Tonner

SAE 30 Suitable for all temperatures above 0° C.

For 1200 and 1500 Transporters

SAE 10 W engine oil is recommended for use if it is anticipated that the temperature will fall below 0° C (32° F) before the next oil changes.

SAE 5 W This oil is for use in arctic climate (below -25° C / -13° F) only (in place of SAE 10 W).

In some countries the API Classification is applied (API= American Petroleum Institute). According to this classification, the HD oils suitable for the VW Engine are referred to as "For Service MS". For further details see page 28.

MULTIGRADE OILS

are HD oils which cover several viscosity grades, such as SAE 10 W-30 for example. These oils are also suitable for VW engines and can be used all the year round.

ADDITIVES

should not be mixed with HD oils.

TRANSMISSION AND DIFFERENTIAL

The transmission and differential gears are combined in the transmission case and both lubricated with the same hypoid oil. Timely oil changes have a beneficial affect on the smooth running of the gear trains. The old oil is drained by removing both the magnetic drain plugs while the oil is at operating temperature.

Then refill with 2.5 liters of hypoid oil (5.3 U.S. pints, 4.4 Imp. pints).

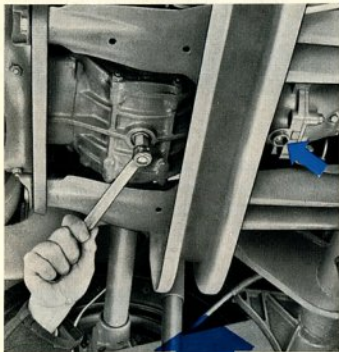

The magnetic drain plugs should be thoroughly cleaned at 500, 5,000 kilometers (300, 1,500, 3,000 miles) and then at every transmission oil change. As the plugs can only retain a limited amount of deposits, the specified cleaning is particularly important when the gears are being run-in. The drain plugs should be removed one after the other and the holes blocked temporarily with a wooden plug.

The oil level must be checked regularly between oil changes and topped up as necessary. The oil should be up to the edge of the filter hole.

Additives should not be used with hypoid oil.

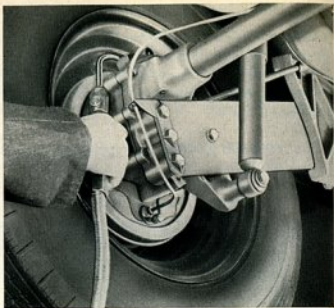

REDUCTION GEAR

Each reduction gear case should be refilled with **0.25 liters of hypoid oil (0.53 U.S. pint, 0.44 Imp. pint)** at the same intervals as the transmission case.

STEERING GEAR

The steering assembly should be lubricated exclusively with SAE 90 hypoid oil, and under no circumstances with grease or any other oil. The level of the oil in the steering case should be kept at the lower edge of the filler plug hole.



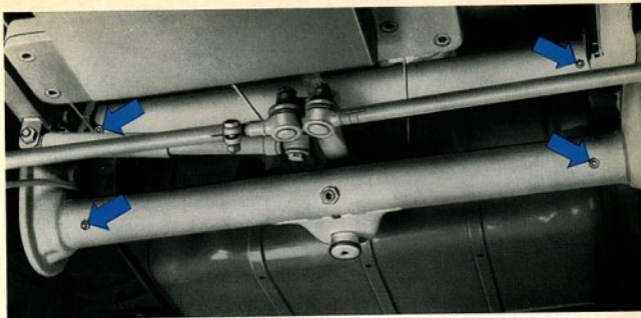

CHASSIS

Proper lubrication of the front axle bearing points can only be ensured by raising the front axle so that the weight is taken off the wheels.

The grease points on the axle tubes, king pins and swing lever shaft should be greased every 2500 km (1500 miles).

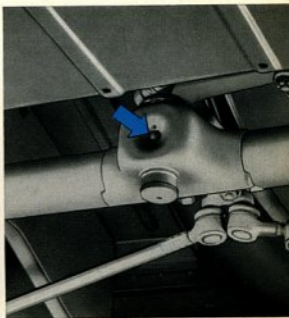
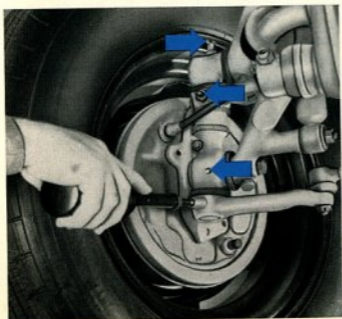

When the vehicle is driven frequently over bad roads it is advisable to grease the king pins in between the normal lubrication services, that is, approximately every 1250 km (750 miles). Before greasing, the nipples should be wiped clean with a rag to prevent dirt from being forced into the bearings. Do not allow grease to get on to the brake hoses and tires. Even small amounts must be removed immediately.

Please check the dust seals of the maintenance free tie rod ends for damage and security at every lubrication service. Damaged seals should be renewed as soon as possible.

The accelerator, clutch and heating cables and the adjusting nut for the clutch cable should be checked for freedom of movement once a year, preferably at the beginning of the cold season. If necessary, clean and grease the parts.

THE FRONT WHEEL BEARINGS

are packed with grease at the factory. The hub caps must be free from grease.

According to the maintenance chart the front wheel bearings are to be cleaned and repacked with grease as specified under the heading "Lubricants" every 50,000 km. (30,000 miles). The brake drums must be removed for this purpose. Finally the front wheel bearings must be adjusted. In order to avoid damage to the bearings this operation should, if possible, be carried out by a VW Dealer.

DRIVER'S SEAT

The upper and lower surfaces of the runners for the driver's seat should be greased lightly to ensure the desired freedom of movement. The runners should be cleaned with a rag before the grease is applied.

DOORS AND LOCKS

The door lock striker plates should be very lightly greased. Apply a few drops of oil to the lid hinges. The door hinges should be oiled at every lubrication service or, better still, once a week after dust and dirt has been removed.

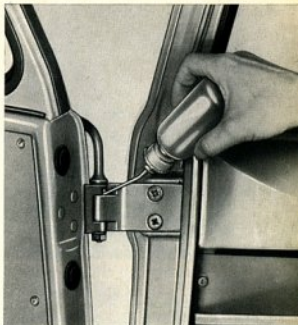
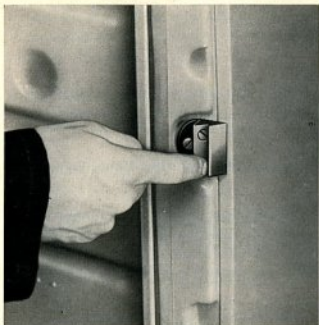

Door cylinder locks should be treated with graphite. Dip the key into the graphite, insert key and move it back and forth several times.

WHEELS AND TIRES

In addition to tire pressures, the mode of driving has a considerable influence on tire wear. Rapid acceleration, hard braking and fast cornering cause excessive and uneven tire wear.

Do not overload the vehicle and try to protect the tires from intense sunlight, fuel and oil.

From time to time the tires should be examined for embedded foreign matter and external damage. The tires should be replaced when the tread depth is down to 1 mm. because beyond this limit the tires are unsafe. If uneven wear is noticed after a considerable mileage, consult your VW Service Station.

For smooth running at high speeds and to obtain a long life, it is important to have the wheels balanced statically and dynamically when tubes or tires have been repaired. As, after long running periods the wheels can be out of balance owing to natural wear of the tires, they should be balanced statically and dynamically every 10,000 km. (6,000 miles).



When the tires are being mounted, the red mark on the sidewall should be lined up with the valve to ensure better balancing of tube and tire.

The spare wheel is stowed in the cab behind the bench seat and is secured with a retaining bracket and wing nut. To take the wheel out, just tip the seat forwards.

The jack and other tools are also stowed underneath the seat.

On the Pick-up the spare wheel is located in the load compartment under the platform.

CHANGING WHEELS

Changing a tire on the road is certainly not pleasant. However, it will be easier after you have read these few lines which tell you the correct way.

1 - Set the handbrake securely and block the wheel opposite the one to be removed to prevent the vehicle from shifting off the jack.

2 - Insert jack into the square tube below the body and turn the hexagon head until the foot touches the ground.

3 - Remove wheel cap with cap removal tool.

4 - Loosen wheel bolts with the socket wrench before wheel is fully jacked up.

5 - Raise vehicle until tire clears ground.

6 - Remove wheel bolts and take off wheel.

7 - When reinstalling the wheel, operate the jack until the five holes in the wheel are nearly lined up with the holes in the brake drum.

8 - First, insert one wheel bolt only. Tighten it enough to allow the wheel to be swung around this point by hand, until the remaining holes in the wheel and brake drum coincide.

9 - Insert and tighten the remaining bolts until the countersunk heads of the five bolts are centered in the corresponding recesses of the wheel.

10 - Tighten all bolts diametrically opposite in turn.

11 - Lower the vehicle, remove jack and make sure that all bolts are tight.

12 - Install wheel cap firmly and make sure that it is tightly seated.





CARE OF THE VW TRANSPORTER

CLEAN AND NEAT APPEARANCE

To keep the VW Transporter looking smart and new is a matter of pride to the driver or owner of the vehicle. Regular and efficient care will protect not only the outer appearance of the vehicle but also the body and the chassis.

WASHING YOUR VEHICLE

Wash your new VW Transporter frequently during the first weeks as this is good for the finish. For washing you require a soft sponge for the body, a soft brush for the wheels, a sturdy, long-handled brush for the chassis and plenty of clear water. For drying you need a chamóis.

The chassis and lower part of the body should first be flushed with water, to soak off the dirt, and afterwards a brush should be used.

Spray the exterior finish of body and wheels with water until dirt is soaked off. Do not allow a powerful jet of water to hit the painted surface. Using plenty of clear water, remove dirt with a sponge. Care should be taken to clean the sponge at short intervals to avoid scratching the paintwork. There are some approved auto soaps and detergents which greatly facilitate this job. Avoid the use of any product which has not been recommended by your VW Dealer. It is of utmost importance to wash the body thoroughly with water after the car-wash has been applied to ensure that no traces of it remain on the body.

After washing, dry off with a clean chamóis to prevent water spots.

PRESERVATION (WAXING)

means to restore to the finish certain substances it has lost by exposure to the weather. As these substances are vitally important to the elasticity of the finish, it is necessary to apply a protective water-repellent coat of wax to the body. The intensive cleaning effect of the shampoo removes this protective coating so that it should be renewed accordingly.

A preservative specially produced for the finish of your VW Transporter can be obtained under the designation "L 190" from your VW Dealer. The body should be waxed after the first eight or ten weeks and then regularly at intervals of from six to eight weeks — in any case after each soap or detergent washing, as already mentioned. Applying the preservative is quite easy: With a soft cloth, spread a thin film on the finish, then rub it down when dry (after about 20 minutes), using polishing cotton or a soft polishing cloth, until iridescent colors can no longer be seen when looking across the polished surface at an angle. Of course, the vehicle must be washed and dried carefully prior to applying the preservative.

POLISHING

You should polish your VW Transporter only if its appearance has been strongly affected by road dust, sunlight and rain in consequence of insufficient care and if the application of the preservative no longer restores the original lustre. Avoid the use of abrasives or chemically harmful products, even if their first application seems to give satisfactory results. A special polish for treating the synthetic-resin finish is also obtainable from your VW Dealer under the designation "L 170". Prior to applying the polish, the car must be washed and dried carefully. Dust or dirt should never be wiped off dry. The polish should be applied with polishing cotton — use a straight horizontal or vertical motion rather than a circular motion. After some rubbing you will feel a slight resistance, which indicates that the ingredients of the polish have settled in the finish and that the solvent has evaporated. Now take clean polishing cotton and rub the body down until the high gloss is restored.

Do not apply the polish on too large an area of the body at a time.

A subsequent application of preservative gives you care-free pride in your car for a long time.

Never wash, wax or polish the vehicle in sunlight.

HOW TO REMOVE SPOTS

Water alone will not always remove splashes of tar, oil traces, "baked on" insects, etc. On principle, such foreign matter should be removed as soon as possible, for if you neglect this, permanent damage to the finish may be the result.

TAR SPOTS. An unpleasant sight, to be noticed particularly on light-colored vehicles, are tiny tar spots which show up on hot days when driving on newly tarred roads. Tar splashes have a tendency to corrode the finish within a short time and should be removed immediately after discovery. On the road, you usually will have nothing at your disposal but fuel, which may be applied with a soft cloth. Kerosene or turpentine oil may also be used. After this, the treated spots should be washed with a mild, lukewarm detergent solution and rinsed, in order to remove traces of the cleansing agent. It is, however, better to use our preservative already mentioned, which renders the treatment with soap solution unnecessary.

INSECTS are caught especially during the night, in hot weather, by the front end of the vehicle. Once baked on they are very difficult to remove with water and sponge, but should be treated with lukewarm detergent solution.

PARKING UNDER TREES

Vehicles which are parked under trees for long periods in summer are often found to be covered with spots. These spots can be removed fairly easily lukewarm detergent solution if the treatment is not delayed too long. It is advisable to apply a coat of preservative afterwards.

CLEANING SUN ROOF

The plastic cover of the sliding roof does not require any special attention. It is, however, essential to clean the top regularly and in good time. When very dirty it should be cleaned with a detergent solution or a normal plastic cleaner. A hard brush can be used to clean the grained surface of the top but take care that the brush does not scratch the paint at the edges of the sliding roof. After cleaning, the top should be rinsed thoroughly with clear water.

Spots can be removed by wiping with a benzine moistened cloth and then washing with a lukewarm detergent solution. The spots should not be removed with paint thinner, chlorine based spot removers or similar solutions as these will attack the plastic material.

CHROMIUM-PLATED PARTS should be treated with "Genuine VW Chrome Cleaner Chromlin" when dry. Apply Chromlin thinly and allow to dry for 10 minutes before polishing with a dry cloth.

CARE OF THE UPHOLSTERY. Cleaning of leatherette upholstery with a soft cloth or soft brush is recommended. Special care should also be taken to remove dust and dirt from the seams. Good results can be obtained using a soft brush and a lukewarm detergent solution. Use the water sparingly, as the upholstery otherwise requires a long time to dry if water trickles through the stitches. Grease and paint spots should be wiped off before they dry up. Soaked-in spots can be removed by carefully using a rag moistened with gasoline or alcohol. Spots caused by shoe polish can be removed with turpentine. Use these agents carefully and sparingly as otherwise, they would tend to dissolve the dust-repellent finish of the leatherette. Solvents such as trichlor-ethylene or paint thinner should not be used. After cleaning, the leatherette should be dried thoroughly with a soft cloth. So-called preservatives are not suitable for leatherette because they do not soak into the material and will merely collect dust and make clothing dirty.

CLEANING GLASS. Windows can be cleaned by washing with warm water and wiping dry with a clean, soft linen cloth. To facilitate this task on the windshield, the arms of the windshield wipers may be tilted forward. To clean exceptionally dirty windows, use alcohol or household ammonia and lukewarm water.

MAINTENANCE

The VOLKSWAGEN SERVICE ORGANIZATION offers you an extensive network of Authorized VW Dealers, staffed with well trained and experienced men and equipped with all the required special tools and appliances to service your vehicle. If ever you should need service when touring, or away from home, look for the well-known VW Service Sign. The workshop displaying this sign is your assurance of the same expert, prompt, and courteous service you are accustomed to receive at home.

In case you can't get to an Authorized VW Dealer in time, we are giving you some information which, if needed, will help you to carry out normal maintenance work. However, repair jobs which are beyond your capacity should be performed by the nearest VW Dealer. There your VW Transporter will be given expert treatment by those familiar with its construction.

This will save you time, inconvenience and money.

Checking Air Cleaner

The oil bath air cleaner should be checked every 5000 km (3000 miles).

All the dust present in the air drawn in by the engine is retained by the filter insert in the upper part of the air cleaner and washed out when the vehicle is in motion by the oil in the lower part of the cleaner. In time, this causes a layer of sludge to form at the bottom of the lower part. If the cleaner check reveals that there is only 4—5 mm (.16—2") of oil above the sludge layer, the lower part should be carefully cleaned and filled with fresh oil. The top part does not need cleaning. However, if the filter insert has become so dirty due to overdue cleaning or oil shortage that the air inlet holes on the underside are partly blocked, the encrusted dirt should be removed, preferably with a small piece of wood.

A dirty filter insert not only reduces the engine output, it can also cause premature wear in the engine. If the local conditions are such that the vehicle is frequently driven over very dusty roads it is advisable to clean the air cleaner more often.

The warm air control flap should be checked each time for freedom of movement. This flap regulates the flow of pre-heated air to the carburetor in conjunction with the speed of the engine.

Servicing Air Cleaner

Pull crankcase breather hose off air cleaner.

Pull warm air hose off air cleaner intake elbow.

Take air cleaner off intake elbow and take upper part off. Never lay the upper part down with the filter element upwards.

Clean the lower part thoroughly and fill to the mark with fresh SAE 20 engine oil.

When installing, ensure that the cleaner fits properly on the intake elbow.



ADJUSTING OR REPLACING THE FAN BELT

To adjust or replace the fan belt, remove nut and outer half of generator pulley. When loosening or tightening nut, insert a screwdriver in the slot in the inner half of the pulley and support it against the upper generator housing bolt. The fan belt tension is adjusted by means of spacer washers situated between the two pulley halves. Belt slackness is taken up by removing one or more washers. If the belt is too taut, one or more washers should be added.

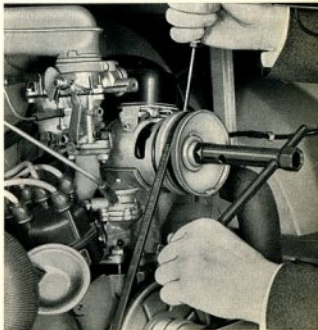

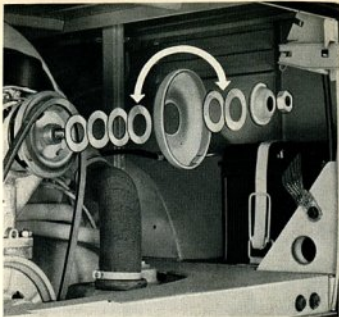

The fan belt should not be too slack, nor should it be too tight. Newly installed belts will stretch to some extent and should, therefore, be checked and adjusted after 500 kilometers (300 miles).

The tension will not alter afterwards and further adjustment is unnecessary. Always keep a new fan belt handy.

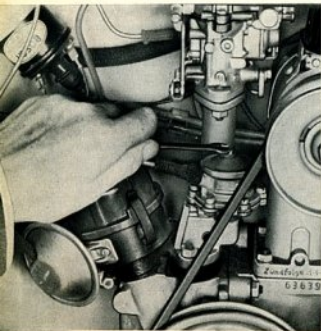

CLEANING THE FUEL FILTER

The fuel pump filter prevents foreign matter and dirt from entering the carburetor.

The filter should be cleaned at the prescribed intervals.

- 1 - Install clip on fuel hose between tank and engine compartment.
- 2 - Remove cover screw and take cover off.
- 3 - Take filter gauze out and clean in benzine.

When installing filter, do not forget cover gasket.

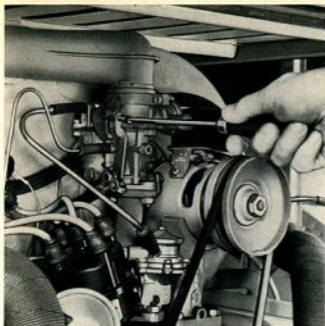

1

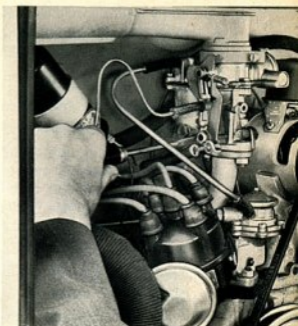

2

CARBURETOR ADJUSTMENT

The carburetor is tested at the factory and properly adjusted to the engine. Do not alter this adjustment by exchanging the jets for other than the prescribed sizes. This would be detrimental under normal operating conditions, and many result in hard starting, excessive fuel consumption or unsatisfactory engine performance.

Only the idling adjustment may call for occasional regulation. Before attempting to adjust the carburetor, make sure the engine is at normal operating temperature.

Also check that the idle adjustment screw is on the lowest step of the fast idle cam of the automatic choke.

- 1 - Turn the idling adjusting screw (1) in or out until normal idling speed is attained (about 550 rpm).
- 2 - Gradually turn the volume control screw (2) to the right until the idling speed drops, then back it off $\frac{1}{4}$ to $\frac{1}{2}$ of a turn to the left.
- 3 - Finally re-adjust the idling speed.

The adjustment is correct if the engine does not stall when the throttle is either suddenly opened or shut with the clutch pedal depressed. Poor idling may also be the result of damaged gaskets, loose intake manifold flanges

faulty ignition or leaky valves. Checking and adjustment of the carburetor, automatic choke and the accelerator pump should be left to an Authorized VW Workshop which has the experience necessary for carrying out such adjustments.

Adjusting the Valves

The valves must only be adjusted when the engine is cold or slightly warm. When adjusting, both valves must be closed, i. e. the piston of the corresponding cylinder must be at TDC on the compression stroke. The arrangement of the cylinders can be seen by the numbers 1 to 4 on the engine cover plates. Valve adjustment is carried out in the following sequence: cylinders 1, 2, 3, 4.

Remove distributor cap.

Crank the engine until the rotor arm points to the No. 1 cylinder mark on the rim of the distributor.

Remove cylinder head cover.

Loosen the adjusting screw lock nuts for the valves of No. 1 cylinder.

Adjust valve clearance with a feeler gauge to 0.20 mm. on the 1200 Transporter and 0.30 mm. on the 1500.

Hold the adjusting screws and tighten the lock nuts.

To adjust the valves for cylinders No. 2, 3 and 4, the engine is turned further anti-clockwise until the rotor arm is 90° offset each time.

The clearance is:	1200 Transporter	1500 Transporter
Inlet valves	0.20 mm. (.008")	0.30 mm. (.012")
Exhaust valves	0.20 mm. (.008")	0.30 mm. (.012")

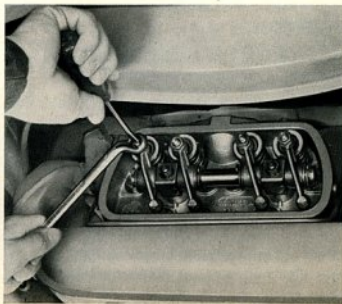

CHECKING THE SPARK PLUGS

Remove the spark plugs and check their exterior. The appearance of electrodes and insulators provides considerable information on engine adjustment and condition.

Electrodes and insulator

medium grey — good adjustment of carburetor and correct performance of spark plug,

black — mixture too rich,

light grey — mixture too lean,

oiled up — misfiring or piston ring blow-by.

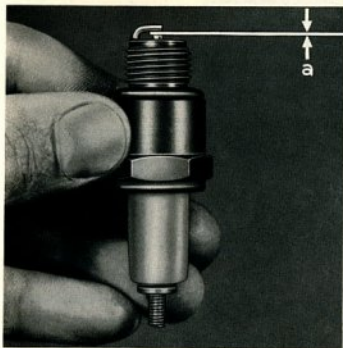

$a = 0.7 \text{ mm.}$
 $.028''$

Clean the spark plugs with a brush and a chip of wood and blow them out. The insulator should be clean and dry on the outside in order to avoid short circuits or tracking. Check the electrode gap (0.7 mm.) and reset if necessary by bending the outer electrode. Use a proper gasket when installing the plug. Generally speaking you may count on a plug service life of up to 15,000 km. (10,000 miles).

CHECK COMPRESSION

After warming up the engine, remove all 4 spark plugs. Operate the starter motor with the accelerator pedal fully depressed and the throttle wide open. The compression is checked by inserting an accurate compression gauge into each spark plug hole.

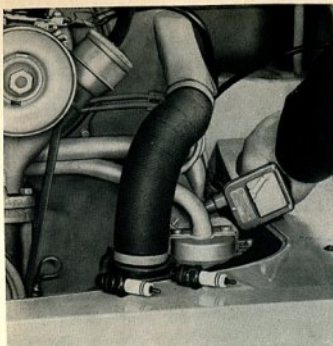

Result:	1200 Transporter	1500 Transporter
Pressure	kg/cm ² (psi)	kg/cm ² (psi)
Good	7—9 (100—128)	9—10 (128—142)
Satisfactory	4.5—7 (65—100)	7—9 (100—128)
Poor	below 4.5 (65)	below 7 (100)

IGNITION TIMING

Particular attention must be paid to correct ignition timing. In many cases poor performance, high fuel consumption and even damage to the engine can be the result of incorrect ignition setting. The ignition must not be advanced arbitrarily not even when using premium grade fuels.

Before setting the ignition timing the breaker contact point gap must be checked. With the breaker arm fully open the clearance should be 0.4 mm (.016"). The initial spark advance must be set to 10° before top dead centre. The ignition timing must only be set with the engine cold or when it is slightly warm.

CLEANING CONTACT POINTS

The contact points must be smooth and make even contact with each other. Dirty contacts should be cleaned and, if pitted, smoothed with a contact file. Whilst doing this, the contact points are pressed lightly together. Afterwards the ignition distributor should be blown out carefully with air. If the points are badly burnt they must be replaced.

LUBRICATION IGNITION DISTRIBUTOR

The breaker arm fiber block in the ignition distributor should always be lubricated with lithium grease. Every 5000 km. (3000 miles) check whether this location must be cleaned and provided with new grease. Only a very small amount of grease should be used and none of it must come in contact with the breaker points as otherwise the ignition will be affected. Every 5000 km, one drop of oil must be applied to the breaker base plate felt ring.

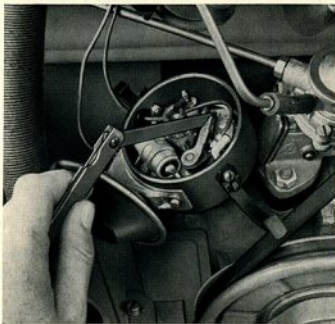

ADJUSTING CONTACTS

Remove distributor cap and rotor.

Turn engine until the breaker arm is fully lifted by a cam lobe.

Loosen fixed point screw.

Place a screwdriver between the two lugs on the breaker plate and the slot in the fixed point and adjust points gap to 0.4 mm (.016").

Tighten screw and install rotor.

Every time the points have been adjusted, the ignition timing must be reset.

ADJUSTING IGNITION TIMING

Turn engine clockwise until the right hand mark on the crankshaft pulley is in line with the crankcase joint and the rotor arm is pointing to the No. 1 cylinder mark on the edge of the distributor housing.

Loosen distributor bracket clamp bolt.

Connect one lead of 6 Volt test lamp to terminal 1 on coil and the other to ground.

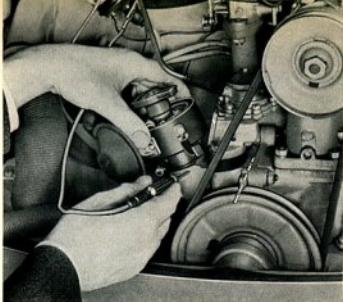

Switch ignition on.

Turn distributor clockwise until the points are closed and then turn slowly anti-clockwise until the points just begin to open and the test lamp lights up.

Tighten clamp bolt.

The timing is correct if the test lamp lights up at the moment the right-hand mark aligns with the crankcase joint when the engine is turned slowly clockwise. The engine should be turned back about a quarter of a turn beforehand to take up the play in the distributor drive.



EXCHANGING FUSES

The fuse box with transparent cover is located below the parcel shelf. When a fuse has burnt out, it is not sufficient merely to replace it by a new one. Inspect the electrical system for evidence of short circuits or other faults that may have caused the fuse to burn. Under no circumstances should you use a fuse patched up with tin-foil or wire, because this may result in severe damage. We suggest that you carry with you a set of spare fuses (8 amp.).

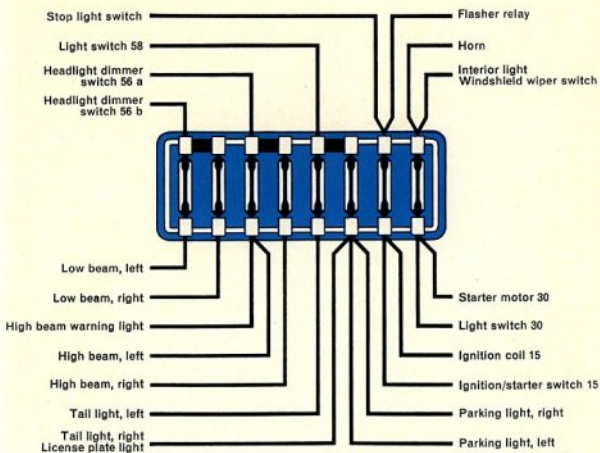

Fuse box below parcel shelf

REPLACING FRONT INDICATOR BULBS

Remove cab front panel lining, disconnect cable from indicator lamp and remove hexagon nut. Remove two screws in rim, take rim with lens and gasket off and change bulb.

When installing, the lugs on the inside of the bulb holder must engage in the slots in the housing welded to the body and the rubber gasket must seat properly on the front panel. Do not overtighten hexagon nut.

REPLACING THE REAR INDICATOR OR STOP AND TAIL LIGHT BULBS

Remove two Phillips screws, take out glass insert and replace damaged bulb:

- Top - Indicator bulb
- Bottom - Stop and tail light bulb.

When replacing the stop and tail light bulb, the retaining pin nearest to the bulb glass must point downwards. The Phillips screws in the glass insert should be tightened evenly but not excessively.

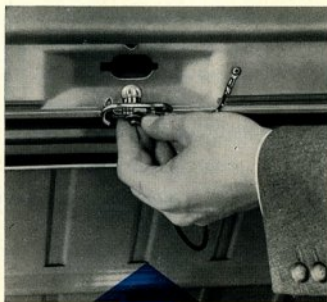

REPLACING LICENSE PLATE LAMP BULB

Open engine compartment lid, take bulb holder out and change bulb. Ensure that the contact springs are clean and correctly tensioned so that the bulb fits tightly and makes good contact.

Warning Light Bulb Replacement

The warning lights for oil pressure, generator charging, flashing indicators, headlight main beam as well as the speedometer and fuel gauge lights are accessible from under the instrument panel. The bulb sockets can be easily removed.

BATTERY MAINTENANCE

Ready starting of the engine depends upon perfect condition of the battery which should be inspected regularly and carefully maintained. The cover can be removed after loosening the snap fastener.

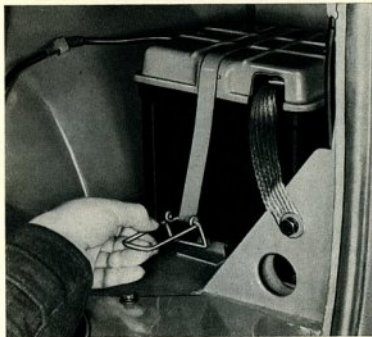

The battery should be checked with a cell tester. This is a voltmeter in parallel with a heavy resistance. The voltage of each cell should not fall below 1.6 volts while taking the reading (10—15 seconds). Otherwise the cell is discharged or defective. Under no-load conditions each charged cell should read 2 volts.

Add distilled water to each cell to bring the level above the plates. The acid level has to be adjusted in accordance with the acid level mark. Losses by evaporation may only be replenished by adding distilled water. Never add acid, unless it is known that acid has been spilled from the battery. Check specific gravity afterwards and compensate if necessary.

Clean terminals with a cloth, or if badly corroded, with a special cleaner. Coat the clean posts and terminals with light grease to prevent corrosion. Then tighten securely and make sure that there is a proper connection to ground.

When laying your vehicle up for a prolonged period, it is advisable to take the battery to a workshop for storage. A battery which is not in constant use will discharge itself in time and this can result in permanent damage to the plates if the battery is not checked about every 4 weeks and charged as necessary.

AIMING THE HEADLIGHTS

If a headlight aiming device is not available, proceed as follows:

- 1 - Stand the empty vehicle on level ground 5 m. (16.4 ft.) in front of a dark wall which will serve as a screen. The tire pressures must be correct.
- 2 - Next draw two setting crosses and lines on the screen according to the sketch.

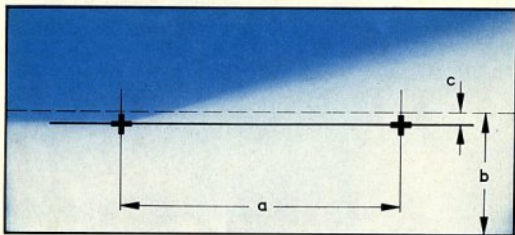

- a = 1012 mm./39.8"
b = height of the headlamp center from the floor
c = 50 mm./2"
(at a distance of 5 m./16.4 ft. from the screen)

- 3 - The longitudinal axis of the vehicle must run through the mid point between the two crosses.
- 4 - The headlamps should be adjusted horizontally and vertically with the beams dimmed.
- 5 - Each lamp must be adjusted separately by turning the slotted screws in the headlamp rim with the second lamp covered up.

Vertical Adjustment (upper screw)

The headlamps should be aimed vertically so that the light-dark border line is horizontally on the adjusting line to the left of the cross and slopes upward to the right of the cross.

Horizontal Adjustment (lower screw)

The headlamps should be aimed horizontally so that the angle on light-dark border line is exactly on the center of the cross.

HEADLIGHT BULB REPLACEMENT

Loosen the slotted screw at the headlamp rim. Take out headlamp. Turn the cap to the left and take the holder out of the reflector. Pull the connector off the bulb base, take off the ground and parking light cables and replace the bulb.

When installing, make sure that the lug in the lamp holder engages in the notch provided in the reflector and that the contact strip is located on the base of the parking light bulb. Never touch the bulb with the bare hand, but only with a clean cloth or a paper serviette etc. When replacing a broken headlamp lens, do not touch or wipe the reflector.

CHECKING BRAKES

If the brake pedal goes down a long way before the brakes take effect, the clearance between brake shoes and drums is excessive. The brake lining wear can be checked through the inspection hole in the brake drum. If the inspection which takes place every 5000 km. (3000 miles) shows that the linings are badly worn, the brakes must be relined. The lining thickness must not be below 2.5 mm. (.090").



BRAKE ADJUSTMENT

Brake adjustment should be performed by an Authorized VW Dealer. However, if an emergency arises where the brakes must be adjusted before you can reach the next repair shop, the following procedure for bleeding and adjusting can be used: The master cylinder is accessible after lifting the inspection plate in the floor of the cab.

To fill up, use only **GENUINE VW BRAKE FLUID** or Lockheed Brake Fluid. The fluid reservoir should be kept at least $\frac{3}{4}$ full at all times.

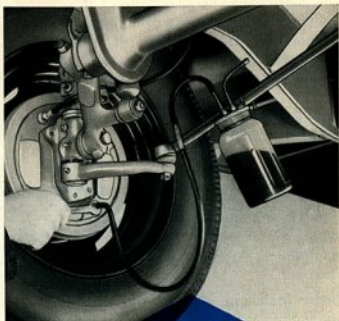

BLEEDING BRAKES

The presence of air in the hydraulic brake system will cause "spongy" brake pedal operation. The system then has to be bled as follows:

- 1 - Remove rubber cap of the bleeder valve of one wheel cylinder and attach one end of the brake bleeder hose to the valve.
- 2 - If an open glass container is used, the end of the hose should be located as high as possible.
- 3 - Loosen the bleeder valve $\frac{1}{2}$ to 1 turn.
- 4 - Pump the brake pedal several times until bubbles cease to appear in the container. Make sure that enough brake fluid remains in the fluid reservoir, as otherwise air will be sucked in.
- 5 - Keep the brake pedal in the fully depressed position until the bleeder valve is closed.

- 6 - Remove bleeder hose and replace bleeder valve rubber cap.
- 7 - Repeat the operations on the other wheels. Finally check and, if necessary, top up fluid in master cylinder reservoir.

ADJUSTING BRAKES

Too much free travel at the brake pedal is an indication that the clearance between brake shoes and brake drums has become too great.

The brake shoes must be adjusted or relined.

- 1 - Remove wheel caps.
- 2 - Jack up the vehicle and turn forward the wheel to be adjusted, until the hole in the brake drum is in line with one of the adjusting nuts.

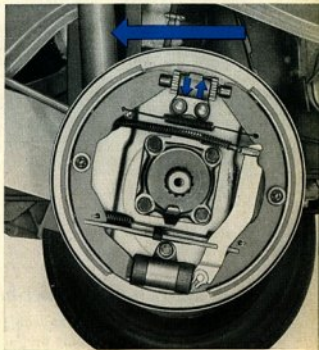
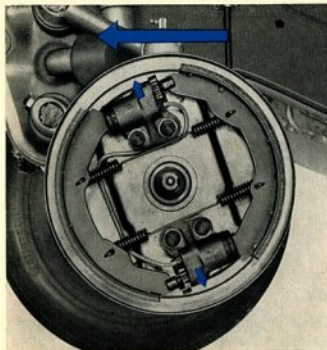
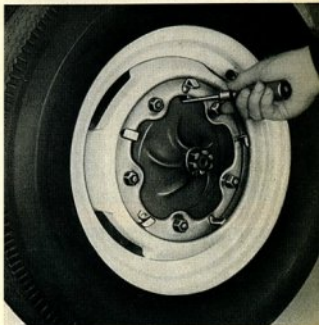

- 3 - Insert a screwdriver through the hole and turn the adjusting nut in the direction indicated by the arrows until a light drag is noted when the wheel is turned by hand.
- 4 - Repeat procedure on the other adjusting nut. Note that the two nuts turn in opposite directions.
- 5 - Back off the adjusting nuts by 3 to 4 teeth until the wheel turns freely.
- 6 - Repeat the above operations on the other wheels.
- 7 - Replace wheel caps securely.

When adjusting the rear wheel brakes, the hand brake must be released. It is advisable to depress the brake pedal sharply before and after adjusting the brake shoes to centralize the shoes in the drums.

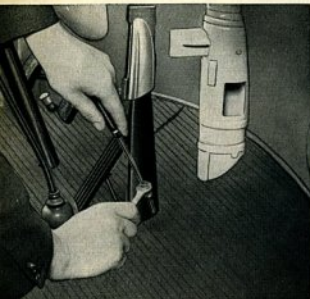

Adjusting hand brake

- 1 - Jack up both rear wheels.
- 2 - Slide hand brake lever boot up.
- 3 - Tighten adjusting nuts of the brake cables to a degree which will still allow the rear wheels to turn freely when the hand brake is released.
- 4 - Pull up hand brake lever two notches and make sure both rear wheels have the same braking effect. At the fourth notch it should be impossible to turn the wheels by hand. Lock adjusting and counter nuts.

CLUTCH PEDAL FREE-PLAY

Easy gear shifting and complete transmission of engine output to gears and wheels can only be guaranteed if the clutch is adjusted as specified.

Measured at the clutch pedal, this free-play should amount to 10—20 mm. (0.4"—0.8") (a). The clearance may be adjusted at the adjusting nut on the cable end.

- 1 - Release lock nut on the threaded cable end.
- 2 - Adjust clutch clearance by turning the adjusting nut. Depress clutch pedal several times and recheck pedal free-play.
- 3 - When the correct adjustment has been reached, hold adjusting nut in position and tighten lock nut.
- 4 - Grease clutch cable adjusting nut with Universal Grease.



STEERING GEAR

In the straight-ahead position there should be no play. The play within the steering mechanism should be as small as possible, but care must be taken that the front wheels resume their straight-ahead position after the vehicle has taken a turn. All operations or adjustments required should only be performed by an Authorized VW Dealer.

FRONT WHEEL BEARINGS

We recommend that you refer this operation to an Authorized VW Dealer, as maladjustment may cause severe damage to the roller bearings. If circumstances require the removal of a front brake drum, the front wheel bearings are to be adjusted as follows:

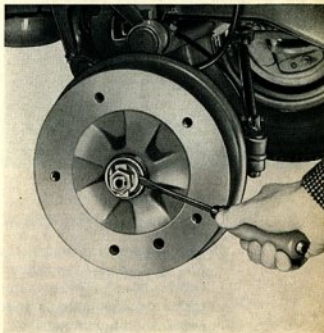

Tighten inner nut until the thrust washer can be moved laterally with a screwdriver easily and no bearing play can be felt when rocking the brake drum. Incorrect adjustment can ruin the bearings in a short time. Finally, secure the nuts by bending down the lock plate.

CHECKING AND ADJUSTING TORSION ARM LINK PINS

The torsion arm link pins should be checked and, if necessary, re-adjusted every 5000 km. (3000 miles). The front end of the vehicle is to be raised so that the weight is taken off the wheels.

CHECKING

Rock the wheel by hand to check for end play between torsion arm link and torsion arms. If play is present, adjust torsion arm link pins.



ADJUSTING

- 1 - Grease the torsion arm link pins.
- 2 - Loosen pinch bolts at torsion arm eyes.
- 3 - Fully tighten link pins first, then back off about $\frac{1}{8}$ of a turn.
- 4 - Tighten the torsion arm link pins until the resistance of the shoulder making contact can be felt.
- 5 - Tighten the pinch bolts again.

If the range of adjustment is insufficient, the shims are worn and should be renewed in a VW Service Station.

After the torsion arm link pins have been adjusted, it is absolutely necessary to check the toe-in.

ADJUSTING THE TOE-IN

With the empty vehicle on the ground, front wheel toe-in should be 0 ± 1 mm. ($0 \pm .04$ in.) and with maximum permissible gross weight it should be 2—5 mm. (.08 to .20 in.). These values can only be accurately checked with a track tester at the workshops. Inadmissible deviations will increase tire wear and impair road holding qualities.



GENERAL DESCRIPTION

ENGINE

The engine, located in the rear of the vehicle, is attached by 4 bolts to the recessed flange of the rubber mounted transmission. Two pairs of cylinders are horizontally opposed. Each pair has one common cylinder head made of light alloy. The overhead valves are located in the cylinder head and are operated from the camshaft by means of push rods, cam followers and rocker arms. The short and counter-balanced crankshaft rests in four bearings and is heat-treated at its four points of support. It drives the camshaft by means of helical gears. The connecting rods are fitted with lead-bronze bearings. The pistons are made of light alloy.

A downdraft carburetor produces the fuel and air mixture to supply the cylinders. The engine is equipped with battery ignition. The spark advance is controlled automatically by a vacuum mechanism.

The oil pump of the full pressure lubrication system is driven by the camshaft and sucks the oil from the crankcase through a strainer and pumps it to the various lubrication points via an oil cooler. In cold weather, when the oil is thicker, an oil pressure relief valve makes it possible for the engine to be lubricated directly, that is, by avoiding the oil cooling system.

The air cooling of the engine is done by means of a fan, which is attached to the generator shaft and driven by an adjustable V-belt. The generator pulley is adjustable to permit adjustment of belt tension. The fan sucks in air through an opening in the fan housing, and the air cools the engine by passing through the cylinder fins. A thermostat controls and regulates the amount of cooling air and ensures well-balanced operating and heating temperatures.

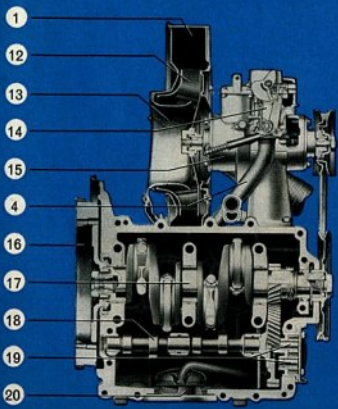
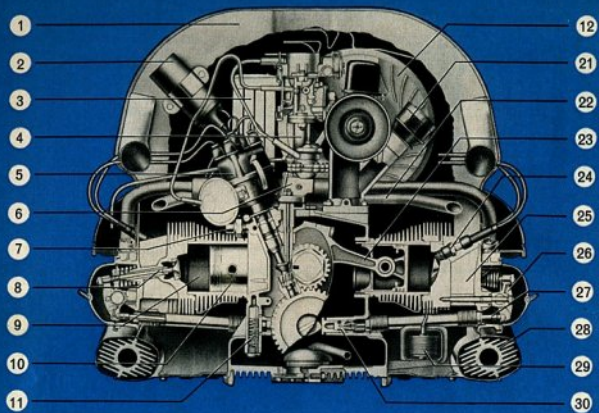

ENGINE

- 1 - Fan housing
- 2 - Ignition coil
- 3 - Oil cooler
- 4 - Intake manifold
- 5 - Distributor
- 6 - Fuel pump
- 7 - Oil pressure switch
- 8 - Valve
- 9 - Cylinder
- 10 - Piston
- 11 - Oil pressure relief valve
- 12 - Fan
- 13 - Throttle ring
- 14 - Carburetor
- 15 - Generator
- 16 - Flywheel
- 17 - Crankshaft
- 18 - Camshaft
- 19 - Oil pump
- 20 - Oil strainer
- 21 - Oil filler and breather
- 22 - Pre-heating pipe
- 23 - Connecting rod
- 24 - Spark plug
- 25 - Cylinder head
- 26 - Rocker arm
- 27 - Push rod
- 28 - Heat exchanger
- 29 - Thermostat
- 30 - Cam follower

TRANSMISSION AND FINAL DRIVE

Power from the engine is transmitted to the gears via a single-plate dry clutch. The transmission provides four speeds forward and one reverse. All models are equipped with a synchromesh transmission. The gears are helically cut to provide silent operation. The drive pinion and the ring gear of the rear axle are cut spirally. The two rear axle shafts swing in the differential housing. Spur wheel reduction gears are provided on the outer ends of the rear axle tubes.

AXLES AND STEERING

The front axle consists of two rigidly joined tubes containing the torsion springs and the suspension arms. The front wheels are sprung independently. The suspension arms form parallelograms assuring proper steering and suspension geometry under all driving conditions. Stops with rubber buffers are provided to prevent excessive rebound.

The steering gear, which is of a worm and peg type, actuates the steering arms of the independent suspension by a draglink and a divided tie rod.

The rear axle is of the swing half-axle type. The rear wheels are also independently sprung by means of adjustable round steel torsion bars. Double acting hydraulic shock absorbers of the telescope type in front and rear prevent rebound.

The foot brake, which operates on all four wheels, is of the hydraulic type. The hand brake operates on the rear wheels through cables.

BODY

The body is of a self-supporting, all-steel design, provided with a strengthening frame to support the axles. The position of the load space within the wheelbase ensures an even distribution of the load on all four wheels, no matter how the load is placed. The load compartment is accessible through a double-wing door from the side and through a hinged rear panel. The tarpaulin of the Pick-Up as well as the bows which are fastened to the platform by means of a few screws can easily be removed and replaced. The driver's compartment, for 3 persons, offers exceptional driving visibility. Adequate ventilation is ensured by vent wings and sliding windows in addition to a fresh air regulator above the windshield.

HEATING

The air drawn in by the fan is heated by the engine. The warm air then passes along a pipe in the center of the vehicle into the cab through a controllable outlet at foot level and two defroster vents at the windshield. On the Micro Buses the passenger compartment is also heated by outlets under the rear seat. The heating is regulated by a knob which is operated from the driver's seat.

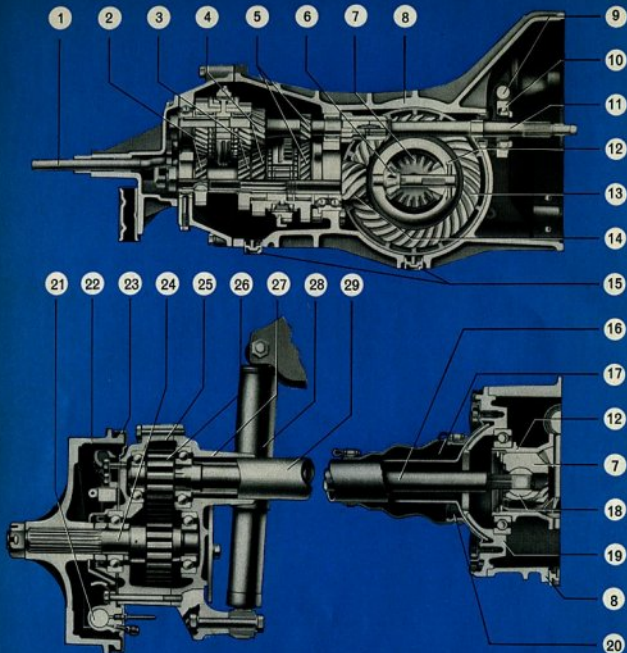

REAR AXLE AND TRANSMISSION

- | | | |
|-----------------------------|-------------------------------|--------------------------------------|
| 1 - Selector shaft, inner | 12 - Differential housing | 21 - Wheel brake cylinder |
| 2 - 4th gear | 13 - Ring gear | 22 - Brake drum |
| 3 - 3rd gear | 14 - Drive pinion | 23 - Brake back plate |
| 4 - 2nd gear | 15 - Magnetic oil drain plugs | 24 - Reduction driven gear and shaft |
| 5 - 1st gear | 16 - Rear axle shaft | 25 - Reduction gear case cover |
| 6 - Differential pinion | 17 - Dust sleeve | 26 - Reduction drive gear |
| 7 - Side gear | 18 - Fulcrum plate | 27 - Reduction gear case |
| 8 - Transmission case | 19 - Final drive cover | 28 - Telescopic shock absorber |
| 9 - Clutch operating shaft | 20 - Rear axle tube retainer | 29 - Rear axle tube |
| 10 - Clutch release bearing | | |
| 11 - Main drive shaft | | |

TECHNICAL DATA

Technical data which differs on the 1 Tonner is listed on page 71

ENGINE

Design	4 Cylinder, 4 stroke, carburetor-type, in rear of vehicle	
Arrangement of Cylinders	Horizontally opposed	
Bore	77 mm. (3.031");	83 mm. (3.267")
Stroke	64 mm. (2.520");	69 mm. (2.716")
Capacity	1192 cc (72.74 cu. in.) 1493 cc (91.10 cu. in.)	
Compression Ratio	7.0:1;	7.8:1
Valves	O. H. Type	
Valve Clearance	Intake 0.20 mm. (.008")	0.30 mm. (.012")
	Exhaust 0.20 mm. (.008")	0.30 mm. (.012")
	to be adjusted when engine is cold	
Brake Horsepower (SAE)	40 hp at 3900 rpm;	50 hp at 3900 rpm
Lubrication	Pressure feed	
	Gear pump with oil cooler	
Oil Capacity	Metric — 2.5 liters	
	U. S. — 5.3 pints	
	Imp. — 4.4 pints	
Fuel Pump	Mechanical type	
Carburetor	Downdraft type Solex 28 PICT	
Cooling System	Air cooling by fan, Thermostat controlled	
Battery	6 Volt, 77 Ampere Hours	
Starter	Electric, 6 Volt, .5 hp;	6 Volt, .6 hp
Generator	6 Volt, 180 Watts at 2500 rpm	
	6 Volt, 200 Watts at 2600 rpm	
	with voltage regulator	
Ignition Distributor	With Vacuum spark advance	
Firing Order	1 — 4 — 3 — 2	
Spark advance	10° before T.D.C.	
Breaker Point Gap	0.4 mm. (.016")	
Spark Plugs	14 mm. thread	
	Bosch W 175 T 1	
	Beru 175/14	
	Champion L 85	
	and plugs of similar values from other manufacturers	
Spark Plug Gap	0.7 mm. (.028")	

CLUTCH

Design	Single disc, dry
Pedal Free-Play	10 to 20 mm. (.4 to .8")

TRANSMISSION

4 Forward speeds, 1 reverse, gears synchronized and silent.

Gear Ratios	First: 3.80:1
	Second: 2.06:1
	Third: 1.22:1
	Top: 0.82:1
	Reverse: 3.88:1

REAR AXLE

Power is transmitted through a helically-cut drive pinion and ring gear, via two swinging axles and spur wheel reduction gears to the rear wheels.

Ratio 4.125:1

Oil capacity of transmission and rear axle	Metric — 3 liters
	U. S. — 6.3 pints
	Imp. — 5.3 pints

REAR WHEEL REDUCTION GEARS

Ratio 1.39:1 1.26:1

Oil capacity of reduction gear cases	Metric — 0.25 liter each
	U. S. — 0.53 pint
	Imp. — 0.44 pint

CHASSIS

Suspension, Front	Two torsion bars
Suspension, Rear	Two torsion bars
Shock Absorbers	Double acting telescopic type, Front and rear
Steering	Ross cam and lever steering gear with hydraulic steering damper
Turns of steering wheel, lock to lock	2.8
Turning Circle	about 12 m. (39 feet)
Foot Brake	Hydraulic, operating on all 4 wheels
Hand Brake	Mechanical, operating on rear wheels
Wheels	4½ K × 15, drop-center type
Tires	6.40—15
Inflation Pressure	Front: 2.0 kg./cm. ² (28 psi) Rear: Up to ¾ payload 2.3 kg./cm. ² (33 psi) With full load ... 2.5 kg./cm. ² (36 psi) Spare wheel ... 2.5 kg./cm. ² (psi)
Ambulance	Front and Rear: 1.8 kg./cm. ² (26 psi)
Wheel Base	2400 mm. (94.5")
Track	Front: 1375 mm. (54.1") Rear: 1360 mm. (53.5")
Toe-in (Vehicle unladen)	0±1 mm. (.04")
(Vehicle fully loaded)	2—5 mm. (.08—.20")

DIMENSIONS AND WEIGHTS

	Delivery Van		Pick-Up and Double Cab		with enlarged platform	with enlarged wooden platform	Ambulance	Fire Truck
	Micro Bus Kombi	MicroBus De Luxe	without tarpaulin	with tarpaulin				
Length	4280 (168.5'')	4300 (169.3'')	4290 (168.9'')	4290 (168.9'')	4290 (168.9'')	4300 (169.3'')	4280 (168.5'')	4280 (168.5'')
Width	1750 (68.9'')	1800 (70.9'')	1750 (68.9'')	1750 (68.9'')	2020 (79.5'')	1980 (78.0'')	1750 (68.9'')	1750 (68.9'')
Height	1940 (76.4'')	1940 (76.4'')	1925 (75.8'')	2215 (87.2'')	1925 (75.8'')	1925 (75.8'')	1930 (76'')	1940 (76.4'')
Ground Clear- ance	225 (8.2'')	225 (8.2'')	225 (8.2'')	225 (8.2'')	225 (8.2'')	225 (8.2'')	205 (8'')	225 (8.2'')

Delivery Van and Kombi

Load Space

Mean Length	2700 mm. (106.3'')	} approx. 4.8 cu. m. (170 cu. ft.)
Mean Width	1500 mm. (59.1'')	
Mean Height	1350 mm. (53.1'')	

Luggage Compartment in Micro Bus

Mean Length	700 mm. (27.6'')	} approx. .8 cu. m. (28 cu. ft.)
Mean Width	1450 mm. (31.5'')	
Mean Height.....	800 mm. (31.5'')	

Pick-Up

Loading Area

Length	2600 mm. (102.4'')	} approx. 4.2 sq. m. (45 sq. ft.)
Width	1570 mm. (61.8'')	
Height of drop sides	375 mm. (14.8'')	
Height of tarpaulin above loading area	1200 mm. (47.2'')	
Height of platform (unladen) above ground.....	985 mm. (38.2'')	

Locker

Length	1200 mm. (47.2'')	} approx. 1.9 sq. m. (20 sq. ft.)
Width	1600 mm. (63.0'')	
Height	340 mm. (13.4'')	
Loading space65 cu. m. (23 cu. ft.)	

WEIGHT IN kg. (lbs.)	Unladen Weight (Ready for operation)	Payload	Max. perm. Gross Weight	Number of Seats
Delivery Van	1070* (2359)	830 (1830)	1900 (4189)	3
High Roofed Delivery Van	1110 (2447)	790 (1741)	1900 (4189)	3
Pick-Up without tarpaulin	1085* (2392)	815 (1797)	1900 (4189)	3
Pick-Up with tarpaulin . .	1120* (2469)	780 (1720)	1900 (4189)	3
Double cab without tarpaulin	1130* (2491)	770 (1698)	1900 (4189)	6
Double cab with tarpaulin	1150* (2535)	750 (1654)	1900 (4189)	6
Pick-Up with enlarged platform	1130* (2491)	770 (1698)	1900 (4189)	3
Pick-Up with enlarged wooden platform	1160* (2557)	740 (1632)	1900 (4189)	3
Kombi	1140** (2514)	760 (1675)	1900 (4189)	9
Micro Bus	1150 (2535)	750 (1654)	1900 (4189)	9
Ambulance	1250 (2756)	650 (1433)	1900 (4189)	7

* with driver ** with seats and driver

Permissible Axle Loads	Front	Rear
in kg. (lbs.)	950 (2095)	1050 (2314)

PERFORMANCE

Maximum Speed	95 kph (60 mph)	105 kph 65 mph
Pick-Up with tarpaulin	90 kph (56 mph)	95 kph 60 mph

Climbing ability, fully loaded:

1st gear	26 %	28 %
2nd gear	13.5 %	14.5 %
3rd gear	7 %	7.5 %
Top gear	4 %	4 %

REFILL REQUIREMENTS

Fuel tank capacity	40 liters (U.S.-10.6 gallons, Imp.-8.8 gallons)
Engine	2.5 liters (5.3 U.S. pints, 4.4 Imp. pints)
Transmission and rear axle	2.5 liters (5.3 U.S. pints, 4.4 Imp. pints)
Reduction gear cases	0.25 liter each (0.53 U.S. pints, 0.44 Imp. pints)
Steering gear	0.25 liter (0.53 U.S. pints, 0.44 Imp. pints)
Brake system	0.3 liter (0.63 U.S. pints, 0.53 Imp. pints)

FUEL CONSUMPTION

Consumption According to DIN 70030

	1200	1500
Delivery Van, Kombi, Micro Bus, Pick-Up without Tarpaulin	9.2 liters 25.5 mpg U. S. 30.7 mpg Imp.	9.5 liters 24.7 mpg U. S. 29.7 mpg Imp.
Pick-Up with Tarpaulin, High Roofed Delivery Van	9.5 liters 24.7 mpg U. S. 29.7 mpg Imp.	9.7 liters 24.2 mpg U. S. 29.1 mpg Imp.

This is the measured consumption plus 10%, determined with half the permissible payload at a continuous $\frac{3}{4}$ of maximum speed on level road.

Oil Consumption	Approx. 0.5—1.4 liters per 1000 km. 1.7—4.8 U. S. pints per 1000 miles 1.4—4.0 Imp. pints per 1000 miles
-----------------------	--

The technical data for the 1500 Transporter is also applicable to the 1 Tonner with the following deviations:

CHASSIS

Rear axle (differential) ratio	1:4.375
Reduction gears	1:1.26
Wheels	5 JKx 14
Tires (tubeless)	7.00—14
Inflation pressures, front	2.0 kg/cm ²
Rear	
Up to $\frac{3}{4}$ payload	2.3 kg/cm ²
With full load	2.8 kg/cm ²
Spare wheel	2.8 kg/cm ²

DIMENSIONS AND WEIGHTS

External Dimensions	Delivery Van Kombi Fire truck	Pick-Up Double Cap Pick-Up		High Roofed Delivery Van	Pick-Up with enlarged wooden platform and with enlarged platform
		with cover	without cover		
Height, unladen .	1925 (75.8")	1910 (75.2")	2200 (86.6")	2285 (90")	1910 (75.2")
Ground clearance loaded	200 (7.8")	200 (7.8")	200 (7.8")	200 (7.8")	200 (7.8")

PICK-UP

Height of platform above ground (unladen) ----- 970 mm (38.2")

Weight in kg (lbs.)	Kerb weight	Payload	Permissible total weight	No. of seats
Delivery Van	1070* (2350)	1000 (2204)	2070 (4563)	3
High Roofed Delivery Van	1110* (2447)	960 (2116)	2070 (4563)	3
Pick-Up without cover ...	1085* (2392)	985 (2271)	2070 (4563)	3
Pick-Up with cover	1120* (2469)	950 (2094)	2070 (4563)	3
Double Cab without cover	1130* (2491)	940 (2072)	2070 (4563)	6
Double Cab with cover ...	1150* (2535)	920 (2028)	2070 (4563)	6
Pick-Up with enlarged platform	1130* (2491)	940 (2072)	2070 (4563)	3
Pick Up with enlarged wooden platform	1160* (2557)	910 (2006)	2070 (4563)	3
Kombi	1140** (2514)	930 (2050)	2070 (4563)	9
Fire Truck	1200 (2645)	950 (2094)	2150 (4739)	3

* with driver

** with seats and driver

	front	rear
Permissible axle loads in kg (lbs.)	950 (2094)	1150 (2534)
Fire Truck	1000 (2204)	1200 (2645)

PERFORMANCE:

Maximum speed:

Delivery Van, Kombi, Pick-Up without cover 105 kph (65 mph)

Pick-Up with cover, High Roofed Delivery Van 95 kph (60 mph)

Climbing ability (fully loaded)

1st gear	26 %
2nd gear	13.5 %
3rd gear	7.0 %
Top gear	4.0 %

FUEL CONSUMPTION

Tested according to DIN 70030:

Delivery Van, Kombi, Pick-Up without cover	9.9 liters per 100 kms 28.5 mpg Imp. 26.75 mpg US.
Pick-Up with cover, High Roofed Delivery Van	10.3 liters per 100 kms 27.4 mpg Imp. 22.8 mpg US.

(This is the measured consumption plus 10%, vehicle with half payload, driven at $\frac{3}{4}$ of maximum speed on a level road).

BULB CHART

V = Volts, W = Watts

Light Description	Designation of Bulb (according to German standard DIN 72 601)	VW Part Number
Headlights	A 6 V 45/40 W	N 17705 1
Parking lights	HL 6 V 4 W	N 17717 1
Flashing indicators, front and rear	R 6 V 18 W	N 17731 1
Tail/stop lights	S 6 V 18/5 W	N 17737 1
License plate light	G 6 V 10 W	N 17719 1
Warning lights	J 6 V 1.2 W	N 17722 1
Speedometer and fuel gauge	J 6 V 1.2 W	N 17722 1
Dome light	L 6 V 5 W	N 17725 1
Micro Bus De Luxe		
Clock light	J 6 V 1.2 W	N 17722 1
Ambulance		
Back-up light	E 6 V 25 W	N 17710 1
Spot light	E 6 V 25 W	N 17710 1
Ambulance Identification light (German type)	R 6 V 18 W	N 17731 1

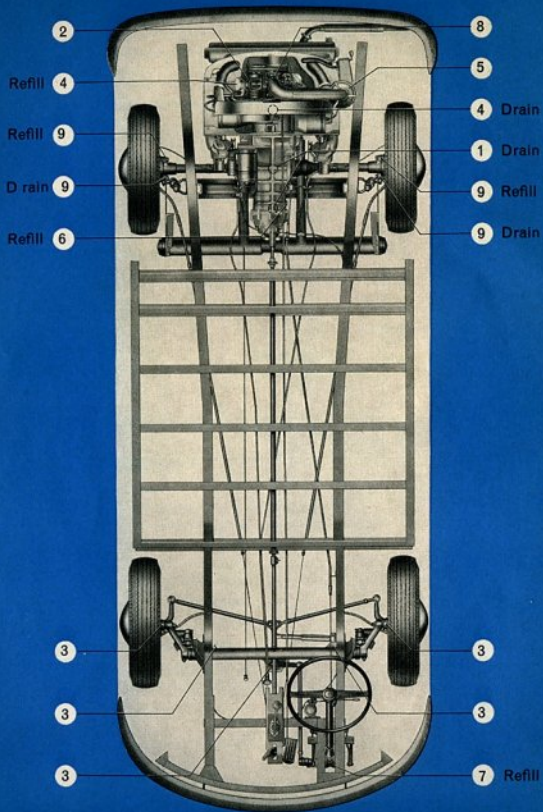

LUBRICATION CHART

500 km. 300 miles	2,500 km. 1,500 miles	5,000 km. 3,000 miles	No.	Lubrication points	Every
			2	Engine: Check oil level	2,500 km. 1,500 miles
			3	Front axle: Lubricate	
				Door hinges	
			4	Engine: Change oil, clean oil strainer	5,000 km. 3,000 miles
			5	Check air cleaner: Clean lower part if necessary	
			6	Transmission: Check oil level	
			7	Steering gear: Check oil level	
			8	Carburetor: Lubricate linkage	
				Door and hood locks	
			1/5	Transmission: Change oil, clean magnetic oil drain plugs	50,000 km. 30,000 miles
			9	Reduction gear cases: change oil	

LUBRICANTS

Lubricant	Lubrication points	Specifications				
		Temperature		Viscosity		
Engine oil (Branded HD oil for spark ignition engines)	Engine, oil bath air cleaner door hinges, carburetor	C°	F°	Transporter 1200 1500		
		above 30	86	SAE 30		
	felt ring in contact breaker base plate	from 0	32	SAE 20 W/20	SAE 30	
		to 30	86			
		below 0	32	SAE 10 W		
below -25	-13	SAE 5 W				
Hypoid oil	Transmission case, reduction gear cases	SAE 90 all the year*				
	Steering gear case	SAE 90 all the year				
Lithium grease	Torsion arms, king pins with torsion arm link pins, swing lever shaft Door and lid locks, front wheel bearings Breaker arm fiber block	Multi-purpose grease				

* SAE 80 all the year in countries with arctic climates.

MAINTENANCE CHART

500 km. 300 miles	5,000 km 3,000 miles	Operation	Every
		Check nuts and bolts on chassis, body, rear axle, front axle and steering for tightness	
		Check rear axle and engine for leaks	
		Check tire pressures and wheel mounting bolts for tightness	
		Check front wheel bearing play	
		Check fan belt	5,000 km. 3,000 miles
		Clean fuel pump filter	
		Check breaker points, grease distributor Check contact breaker gap and timing	
		Check valve clearance	
		Check spark plugs and compression	
		Check exhaust system for damage Check rubber valve in crankcase ventilation system	
		Check clutch pedal free-play	
		Check torsion arm link pins, front wheel bearing play, tie rod end dust seals, tie rod ends, steering damper mounting and toe-in	
		Check steering adjustment	
		Check tire wear, damage and pressure	
		Check hydraulic brake system lines and connections for leakage and damage. Check brake fluid level and adjustment of hand and foot brakes	
		Check thickness of brake linings through inspection hole	
		Check battery, operation of complete electrical system and headlight alignment	
		Road test vehicle, check foot and hand brake efficiency. Check idling adjustment and heating	
		Clean, grease and adjust front wheel bearings	50,000 km. 30,000 miles

INDEX

	Page		Page
Accelerating	23	Driving the VW Transporter ...	13
Accelerator pedal	5	Driving down-hill	16
Accessories	2	Drying tarpaulin	19
Additives — Engine	32	Economy	22
— Transmission	33	Engine—compression ratio ...	67
Air cleaner — cleaning	44	— description	63
Ambulance — specifications ..	69/70	— design	67
Ash tray	20	— lubrication	
Axle loads	72	(oil change)	29/30
Battery — maintenance	55	— oil change in winter ...	27
— care in winter	28	— oil level	8
Body — description	65	— oil strainer	30/31
Brakes — adjusting	58	— permissible rpm	67
— application	15	— sectional view	64
— bleeding	58	— technical data	67
— care in winter	28	— type of oil	9/32
— checking	11	Engine compartment lid	
— description	68	— releasing check mechanism	8
Breaking-in (running-in) period .	21	Fan belt — adjusting	45
Carburetor — adjusting	47	— checking tension ...	9
— type	67	Flashing indicator switch	5
Care of the VW Transporter ...	40	Foot brake — adjusting	58
Chains	28	— description	65
Chassis — care in winter	27	Fresh air regulator	
Chassis number	6	— description and operation .	18
Chromium-plated parts — care .	43	Front axle — description	65
Climbing ability	72	— lubrication	34
Clutch — design	67	— technical data	68
— pedal	5	Front wheel bearings — adjusting	61
— pedal free-play	67	— lubrication	36
Controls and instruments	3	Fuel consumption	72
Cold weather hints	26	Fuel pump — cleaning	46
Cooling of engine	63	Fuel gauge	10
Delivery Van — specifications ..	69	Fuse box	53
Dimensions — inside and outside	69	Fuses exchanging	52
Dimmer switch — headlight ...	5	Gear lever	5
Door locks — lubrication points	37	Generator	67
		Ground clearance	69

	Page		Page
Hand brake — adjusting	60	Passing other cars	24
— description	65	Pick-up — specifications	69
Headlights — aiming	56	Polishing the paintwork	41
— replacing bulb	57	Practical driving	21
Heating — description	65		
— operation	26	Ratios — rear axle	68
Horn button	5	— transmission	68
		Rear axle — description	65
Identification plate	6	— lubrication	30
Idling — checking and adjusting	47	— reduction gears	70
Ignition — breaker point gap	51	— sectional view	66
— distributor	67	— technical data	68
firing order	67	— transmission of	
— timing	51	power	68
Instrument panel light	11	Rear view mirror	17
Interior light	17	Reverse gear	14
Jack — application	39	Safety in traffic	24
		Seat Adjustment	16
Key — doors and ignition	3	Sectional view with explanations	64
Kombi — specifications	69	Shifting gears	14
		Shifting to reverse	14
License plate light		Shock absorbers — design	68
— replacing bulb	54	Sliding door	19/20
Light switch — positions	11	Spare wheel	38
Lubricants	75	Spark plug —checking and	
Lubrication	29	cleaning	49
Lubrication Chart	75	—gap	49
Lubrication points	74	Speedometer	3
		Speed ranges	21
Maintenance Chart	76	Spots — removal	42
Maximum performance	72	Starting — danger in closed	
Maximum speed	72	rooms	13
Micro Bus — specifications	70	— in winter	12
Multigrade oils	32	— with engine cold	12
		— with engine hot	12
Oil consumption	70	Starting motor	67
Oil level — engine	8	Steering adjusting	61
— steering gear	34	— description	65
— transmission	33	— maintenance	61
One Tonner — Tire pressure	71	— type	68
Technical data	67	Steering-ignition lock — starting	13
		— locking	16
Paintwork — preservation	41		
Parking your Transporter	25		

	Page		Page
Steering wheel	5	Turning circle	68
Stop light — bulb replacement ..	54	Type of fuel	10
— checking	11	Upholstery — care	43
Stopping the vehicle—generally.	16	Valves — adjusting	48
— temporarily	24	— arrangement	67
Sun roof — cleaning	42	— clearance	48/67
— operation	19	Vent wing	5
Suspension — front	68	Warning lights	
— rear	68	— flashing indicator	3/23
Technical data	67	— generator and cooling ...	3/23
Tires — inflation pressure	11	— headlight	3/23
— maintenance	38	— oil pressure	3/23
— M+S	28	— replacing bulbs	54
— size	68	Washing your vehicle	40
— wear	39	Weights	71
Toe-in of front wheels	68	Wheel base	68
Toe-in, adjusting	62	Wheels — balancing	38
Tools and accessories	III	— changing	39
Track (tread)	68	— rim size	68
Transmission — description	65	Windows	16
— oil change and		Windshield — cleaning	43
capacity	33	Windshield wiper switch	5
— sectional view .	66	— cleaning blades .	18
— technical data .	67		

VW Transporter, Sectioned

- 1 - Pedals
- 2 - Steering gear
- 3 - Hand brake lever
- 4 - Brake master cylinder
- 5 - Gear lever
- 6 - Front axle
- 7 - Front shock absorber
- 8 - Spare tire and wheel
- 9 - Jack socket
- 10 - Fresh air regulator
- 11 - Heated air duct
- 12 - Side member
- 13 - Torsion bar seat
- 14 - Fuel tank
- 15 - Transmission
- 16 - Rear shock absorber
- 17 - Reduction gears
- 18 - Air cleaner
- 19 - Carburetor
- 20 - Distributor
- 21 - Generator
- 22 - Muffler
- 23 - Battery

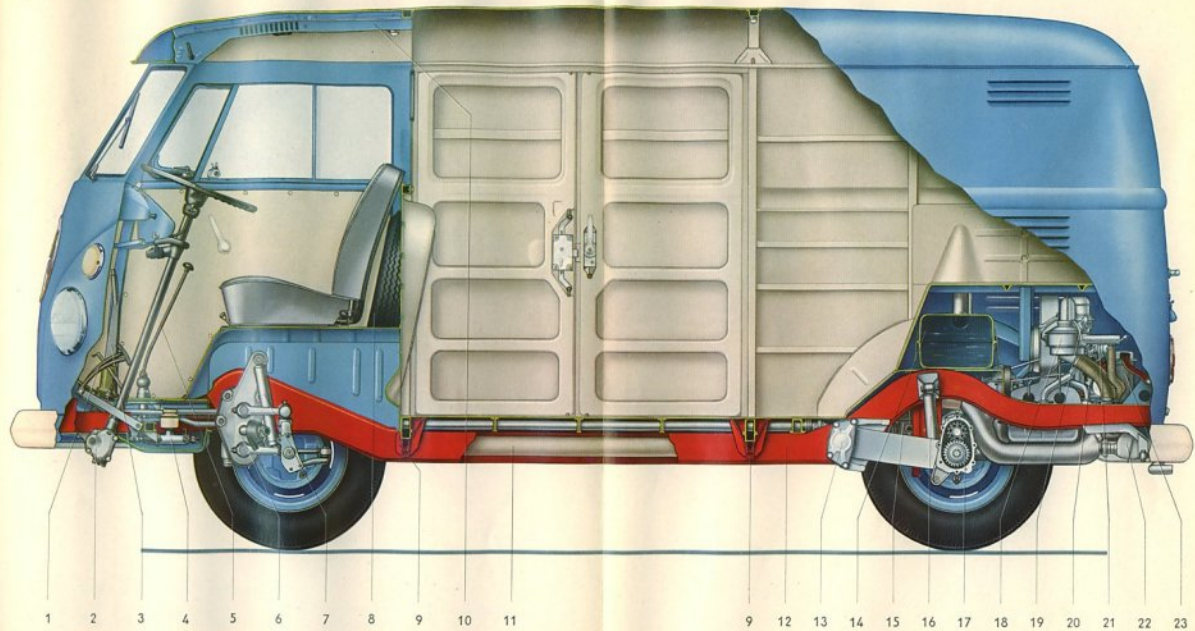

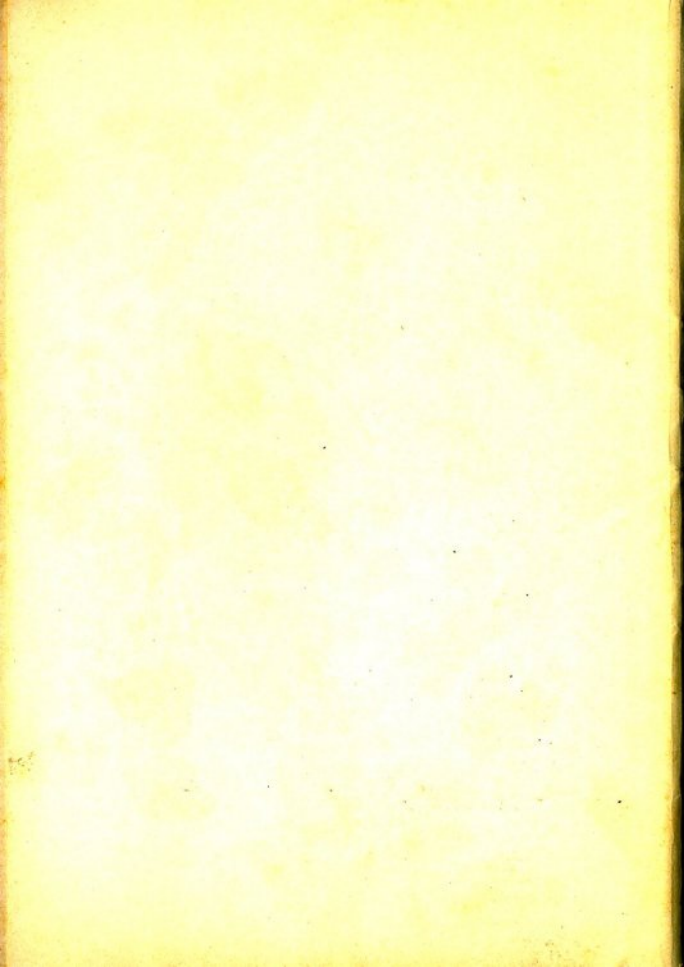

Tools and Accessories

- 1 Fan Belt
- 1 Tool Roll
- 1 Spare Wheel
- 1 Jack
- 1 Wheel Cap Removal Tool
- 1 Square Key
- 1 Combination Pliers
- 1 Screwdriver with double-ended blade
- 1 Socket Wrench 14 mm.
- 1 Socket Wrench for Spark Plugs, Wheel Bolts,
Pulley and Jack
- 1 Open End Wrench 8/13 mm.
- 1 Tommy Bar for Socket Wrench
- 1 VW Service Booklet

Transporter 1500 additional:

- 1 Socket Wrench with Tommy Bar for Spark Plugs.

© 1963 VOLKSWAGENWERK AKTIENGESELLSCHAFT

All rights reserved. May not be reproduced or translated in whole or in part without the written consent of Volkswagenwerk. Specifications subject to alteration without notice.

