

Volkswagen VIN Breakdown

U.S. Models

WMI

Position	1	2	3	4	5	6	7	8
	1	2	3	1	2	3	4	5

VDS

Position No. Block Description Characters Description

1-3	Mfg. Make	WVW	VW - Europe	Pass. Car
		WV2	VW - Europe	MPV
		3VW	VW - Mexico	Pass. Car

4 Series 2 dr. 4 dr.

Cabrio	A	GLS
	B	GLS
Golf	F	GL
	J	Wolfsburg Edition
GTI	H	VR6
Jetta	R	GL / TDI
	P	Wolfsburg Edition
	T	GLX
New Beetle	B	GL
	C	GLS
	D	GLX
Passat	M	GLS
	N	GLS Wagon
	T	GLS Syncro
	R	GLS Syncro Wagon
	U	GLX Syncro
	W	GLX Syncro Wagon
EuroVan	K	GLS
	M	MV
	N	MV Weekender
	E	Camper

1999 Model Year

VIS

9		10	11	12	13	14	15	16	17
	1	2	3	4	5	6	7	8	

Position No. Block Description Characters Description

5	Engine Type	See Chart							
6	Restraint System	O	■						
	Golf, Jetta, Cabrio, and New Beetle	8	4	AirBag - Dr/Pass Active - Dr/Pass					
	Passat	6	2	As above + Side AirBag Front - Dr/Pass					
	EuroVan		6	As #4 Above + Side AirBag Fr. & Rr. - Dr/Pass					
			8	As #4 Above					

O Standard Air Bags
 ■ Depowered Air Bags

7-8 Model

1C	New Beetle
1E	Cabrio
1H	Golf / GTI / Jetta
3B	Passat
70	EuroVan

9 Check Digit

*	*Calculate per NHTSA Code
---	---------------------------

10 Model Year

X	1999
---	------

11 Plant of Mfg.

E	Emden
H	Hannover
M	Mexico
VV	Wolfsburg

12-17 Sequential Production No.

Engine Type - 1999 Volkswagen Vehicles

U.S. Models

Code	Attributes	Golf / Jetta / GTI	Cabrio	New Beetle	Passat	EuroVan
A	Fuel Cyl. Disp. HP MFG. E.F.	GAS (Fed. Only) 4 1984 cc / 121 cid 115 VW XVWXV02.0229		GAS (Fed. Only) 4 1984 cc / 121 cid 115 VW XVWXV02.0222	GAS (50-St./Can.) 4 1781 cc / 109 cid 150 VW XAD XV01.8322	
B	Fuel Cyl. Disp. HP MFG. E.F.	GAS (50-St) 4 TLEV 1984 cc / 121 cid 115 VW WVWXV02.0223	GAS (50-St./Can.) 4 TLEV 1984 cc / 121 cid 115 VW WVWXV02.0223			
C	Fuel Cyl. Disp. HP MFG. E.F.			GAS (50-St.) 4 LEV 1984 cc / 121 cid 115 VW XVWXV02.0227		
D	Fuel Cyl. Disp. HP MFG. E.F.	GAS (50-St./Can.) 6 2792 cc / 170 cid 172 VW XVWXV02.8221			GAS (50-St./Can.) 6 2771 cc / 169 cid 190 VW XAD XV02.8324	
E	Fuel Cyl. Disp. HP MFG. E.F.					
F	Fuel Cyl. Disp. HP MFG. E.F.	Diesel (50-St./Can.) 4 1896 cc / 116 cid 90 VW XVWXV01.9232		Diesel (50-St./Can.) 4 1896 cc / 116 cid 90 VW XVWXV01.9233		
G	Fuel Cyl. Disp. HP MFG. E.F.					GAS (50-St./Can.) 6 2792 cc / 169 cid 140 VW XVWX02.8225

California models are also sold in New York, Massachusetts and Vermont.

Volkswagen VIN Breakdown

U.S. Models

WMI

Position	1	2	3
	1	2	3

VDS

	4	5	6	7	8
	1	2	3	4	5

VIS

	10	11	12	13	14	15	16	17
	1	2	3	4	5	6	7	8

1998 Model Year

Position No.	Block Description	Characters	Description	Position No.	Block Description	Characters	Description									
1-3	Mfg. Make	<table border="1"> <tr> <td>VWVW</td> <td>VW - Europe Pass. Car</td> </tr> <tr> <td>3VWV</td> <td>VW - Mexico Pass. Car</td> </tr> </table>	VWVW	VW - Europe Pass. Car	3VWV	VW - Mexico Pass. Car		5	Engine Type	See Chart						
VWVW	VW - Europe Pass. Car															
3VWV	VW - Mexico Pass. Car															
4	Series	2 dr. 4 dr.		6	Restraint System	<table border="1"> <tr> <td>6 #</td> <td>AirBag - Dr/Pass Side AirBag Front Dr/Pass</td> </tr> <tr> <td>8</td> <td>Active - Dr/Pass AirBag - Dr/Pass Active - Dr/Pass</td> </tr> </table>	6 #	AirBag - Dr/Pass Side AirBag Front Dr/Pass	8	Active - Dr/Pass AirBag - Dr/Pass Active - Dr/Pass						
6 #	AirBag - Dr/Pass Side AirBag Front Dr/Pass															
8	Active - Dr/Pass AirBag - Dr/Pass Active - Dr/Pass															
	Cabrio	A GL B GLS		7-8	Model	<table border="1"> <tr> <td>1E</td> <td>Cabrio</td> </tr> <tr> <td>1H</td> <td>Golf / GTI / Jetta</td> </tr> <tr> <td>3B</td> <td>Passat</td> </tr> </table>	1E	Cabrio	1H	Golf / GTI / Jetta	3B	Passat				
1E	Cabrio															
1H	Golf / GTI / Jetta															
3B	Passat															
	Golf	F GL / TDI K K2		9	Check Digit	* Calculate per NHTSA Code										
	GTI	D H VR6		10	Model Year	W 1998										
	Jetta	R GL / TDI S GLS T GLX V GT Y K2		11	Plant of Mfg.	<table border="1"> <tr> <td>B</td> <td>Brussels</td> </tr> <tr> <td>E</td> <td>Emden</td> </tr> <tr> <td>H</td> <td>Hannover</td> </tr> <tr> <td>M</td> <td>Mexico</td> </tr> <tr> <td>W</td> <td>Wolfsburg</td> </tr> </table>	B	Brussels	E	Emden	H	Hannover	M	Mexico	W	Wolfsburg
B	Brussels															
E	Emden															
H	Hannover															
M	Mexico															
W	Wolfsburg															
	Passat	M GLS / TDI N GLS / TDI Wagon P GLX T GLS Syncro Wagon		12-17	Sequential Production No.											

Engine Type - 1998 Volkswagen Vehicles

U.S. Models

Code	Attributes	Golf / Jetta / GTI	Cabrio	Passat
A	Fuel Cyl. Disp. HP MFG. E.F.	GAS (Fed. Only) 4 1984 cc / 121 cid 115 VW WWWXV02.0222	GAS (Fed. Only) 4 1984 cc / 121 cid 115 VW WWWXV02.0222	GAS (51-St) 4 1781 cc / 109 cid 150 VW WADXV01.8322
B	Fuel Cyl. Disp. HP MFG. E.F.	GAS (Cal.) 4 1984 cc / 121 cid 115 VW WWWXV02.0223	GAS (Cal.) 4 1984 cc / 121 cid 115 VW WWWXV02.0223	
C	Fuel Cyl. Disp. HP MFG. E.F.			
D	Fuel Cyl. Disp. HP MFG. E.F.	GAS (51-St) 6 2792 cc / 170 cid 172 VW WWWXV02.8224		GAS (51-St) 6 2771 cc / 169 cid 190 VW WADXV02.8324
E	Fuel Cyl. Disp. HP MFG. E.F.			
F	Fuel Cyl. Disp. HP MFG. E.F.	Diesel (51-St, M5) 4 1896 cc / 116 cid 90 VW WWWXV01.9232		
G	Fuel Cyl. Disp. HP MFG. E.F.			Diesel (51-St) 4 1896 cc / 116 cid 90 VW WWWXV01.9234
H	Fuel Cyl. Disp. HP MFG. E.F.			

California models are also sold in New York, Massachusetts and Connecticut.

Volkswagen VIN Breakdown

U.S. Models

WMI

Position	1	2	3
	1	2	3

VDS

4	5	6	7	8
1	2	3	4	5

1997 Model Year

VIS

9	10	11	12	13	14	15	16	17
	1	2	3	4	5	6	7	8

Position No. Block Description Characters Description

1-3 Mfg. Make

WVW	VW - Europe Pass. Car
WV2	VW - Europe MPV
3VW	VW - Mexico Pass. Car

4

Series 2 dr. 4 dr.

Cabrio	A		Highline
	B		
Golf	F	GL / TDI	
	K	K2	
GTI	D		VR6
	H		
Jetta	V	GT	
	R	GL / TDI	
	S	GLS	
	T	GLX	
Passat	G	GLS / TDI	
	H	GLS / TDI Wagon	
	E	GLX	
	F	GLX Wagon	

4

Series 3 dr.

EuroVan	K	GLS
	M	MV
	E	Camper

5 Engine Type

See Chart

6

Restraint System

0	Active - Dr/Pass
8	AirBag - Dr/Pass Active - Dr/Pass

7-8

Model

1E	Cabrio
1H	Golf / GTI / Jetta
3A	Passat
70	EuroVan

9

Check Digit

.	*Calculate per NHTSA Code
---	------------------------------

10

Model Year

V	1997
---	------

11

Plant of Mfg.

B	Brussels
E	Emden
H	Hannover
K	Osnabrueck
M	Mexico
W	Wolfsburg

12-17

Sequential Production No.

Engine Type - 1997 Volkswagen Vehicles

U.S. Models

Code	Attributes	Golf / Jetta / GTI	Cabrio	Passat	EuroVan
A	Fuel Cycl. Disp. HP MFG. E.F.	GAS (51-St) 4 1984cc / 121cid 115 VW VWV2.0V8GKEM	GAS (51-St) 4 1984cc / 121cid 115 VW VWV2.0V8GKEM		
B	Fuel Cycl. Disp. HP MFG. E.F.	GAS (Cal.) 4 1984cc / 121cid 115 VW VWV2.0V8G2EL			
C	Fuel Cycl. Disp. HP MFG. E.F.			GAS (51-St) 4 1984cc / 121cid 115 VW VWV2.0V8GKEM	
D	Fuel Cycl. Disp. HP MFG. E.F.	GAS (51-St.) 6 2792cc / 170cid 172 VW VWV2.8V8GFGM			
E	Fuel Cycl. Disp. HP MFG. E.F.			GAS (51-St.) 6 2792cc / 170cid 172 VW VWV2.8V8GFGM	
F	Fuel Cycl. Disp. HP MFG. E.F.	Diesel (51-St, M5) 4 1896cc / 116cid 90 VW VWV1.9V6DKYM			
G	Fuel Cycl. Disp. HP MFG. E.F.			Diesel (51-St) 4 1896cc / 116cid 90 VW VWV1.9V6DKYM	
H	Fuel Cycl. Disp. HP MFG. E.F.				GAS (51-St.) 6 2792cc / 170cid 140 VW VWV2.828GFGM

California model is also sold in New York and Massachusetts.

Volkswagen VIN Breakdown

Canadian Models

1997 Model Year

WMI

Position	1	2	3
	1	2	3

VDS

	4	5	6	7	8
	1	2	3	4	5

VIS

	10	11	12	13	14	15	16	17
	1	2	3	4	5	6	7	8

Position No. Block Description

1-3 Mfg. Make

Characters Description

WVW	VW - Europe Pass. Car
WV1	VW - Europe Truck
WV2	VW - Europe MPV
3VW	VW - Mexico Pass. Car

4

Series

2 dr. 4 dr.

Cabrio	A		Highline
	B		
Golf	A	E	CL
	B	F	GL / TDI
		K	K2
	D		GTI
Jetta	H		GTI VR6
		R	GL / TDI
Passat		V	GT
		S	GLS
		T	GLX
Passat		A	GLS / TDI
		B	GLS / TDI Wagon
		C	GLX
		D	GLX Wagon

Position No.

4

Block Description

Series

Characters

Description

EuroVan	E		Panel Van / Camper
	K		GLS
	M		MV

Engine Type

See Chart

5

Restraint System

0	Active - Dr/Pass
8	AirBag - Dr/Pass
	Active - Dr/Pass

7-8

Model

1E	Cabrio
1H	Golf / GTI / Jetta
3A	Passat
70	EuroVan

9

Check Digit

*	*Calculate per NHTSA Code
---	---------------------------

10

Model Year

V	1997
---	------

11

Plant of Mfg.

B	Brussels
E	Emden
H	Hannover
K	Osnabrueck
M	Mexico
W	Wolfsburg

12-17

Sequential Production No.

Engine Type - 1997 Volkswagen Vehicles

Canadian Models

Code	Attributes	Golf / Jetta / GTI	Cabrio	Passat	EuroVan
A	Fuel Cycl. Disp. HP MFG. E.F.	GAS (51-St) 4 1984cc 115 VW VWV2.0V8GKEM	GAS (51-St) 4 1984cc 115 VW VWV2.0V8GKEM		
C	Fuel Cycl. Disp. HP MFG. E.F.			GAS (51-St) 4 1984cc 115 VW VWV2.0V8GKEM	
D	Fuel Cycl. Disp. HP MFG. E.F.	GAS (51-SL) 6 2792cc 172 VW VWV2.8V8GFGM			
E	Fuel Cycl. Disp. HP MFG. E.F.			GAS (51-SL) 6 2792cc 172 VW VWV2.8V8GFGM	
F	Fuel Cycl. Disp. HP MFG. E.F.	Diesel (51-SL M5) 4 1896cc 90 VW VWV1.9V6DKYM			
G	Fuel Cycl. Disp. HP MFG. E.F.			Diesel (51-SL) 4 1896cc 90 VW VWV1.9V6DKYM	Diesel (Can. Only) 5 2370cc 77 VW D2-W02-92
H	Fuel Cycl. Disp. HP MFG. E.F.				GAS (51-SL) 6 2792cc 140 VW VWV2.828GFGM
J	Fuel Cycl. Disp. HP MFG. E.F.	Diesel (Can. Only) 4 1896cc 74 VW D1-W03-92			
K	Fuel Cycl. Disp. HP MFG. E.F.	GAS (Can. Only) 4 1781cc 90 VW VWV1.8V5AA			
L	Fuel Cycl. Disp. HP MFG. E.F.	GAS (Can. Only) 4 1984cc 115 VW SVW2.0V8GFEA	GAS (Can. Only) 4 1984cc 115 VW SVW2.0V8GFEA		

Volkswagen VIN Breakdown

U.S. Models

WMI

Position 1	2	3
1	2	3

VDS

4	5	6	7	8
1	2	3	4	5

1996 Model Year

VIS

9	10	11	12	13	14	15	16	17
	1	2	3	4	5	6	7	8

Position No.	Block Description	Characters	Description
1-3	Mfg. Make	WVW 3VW	VW - Europe Pass Car VW - Mexico Pass Car
4	Series	2 dr 4 dr	
	Cabrio	B	
	Golf	F	GL / TDI
	GTI	D H	VR6
	Jetta	R S T	GL / TDI GLS GLX
	Passat	G H E F	GLS / TDI GLS / TDI Wagon GLX GLX Wagon

Position No.	Block Description	Characters	Description
5	Engine Type	See Chart	
6	Restraint System	8	AirBag - Dr/Pass Active - Dr/Pass
7-8	Model	1E 1H 3A	Cabrio Golf GTI Jetta Passat
9	Check Digit	.	*Calculate per NHITSA Code
10	Model Year	T	1996
11	Plant of Mfg.	E K M W	Emden Osnabrueck Mexico Wolfsburg
12-17	Sequential Production No.		

Engine Type - 1996 Volkswagen Vehicles U.S. Models

Code	Attributes	Golf / Jetta / GTI	Cabrio	Passat
A	Fuel Cyl. Disp. HP MFG. E.F.	GAS (51-St) 4 1984 115 VW TVW2.0V8GKEM	GAS (51-St) Mex. 4 1984 115 VW TVW2.0V8GFEM	
B	Fuel Cyl. Disp. HP MFG. E.F.	GAS (Cal.) 4 1984 115 VW TVW2.0V8G2EL	GAS (51-St) Germ 4 1984 115 VW TVW2.0V8GFEM	
C	Fuel Cyl. Disp. HP MFG. E.F.			GAS (51-St) 4 1984 115 VW TVW2.0V8GFEM
D	Fuel Cyl. Disp. HP MFG. E.F.	GAS (51-St.) 6 2792 172 VW TVW2.8V8GFGM		
E	Fuel Cyl. Disp. HP MFG. E.F.			GAS (51-St.) 6 2792 172 VW TVW2.8V8GFGM
F	Fuel Cyl. Disp. HP MFG. E.F.	Diesel (51-St, M5) 4 1896 90 VW TVW1.9V6DFYE		
G	Fuel Cyl. Disp. HP MFG. E.F.	Diesel (51-St, A4) 4 1896 90 VW TVW1.9V6DFZE		Diesel (51-St) 4 1896 90 VW TVW1.9V6DFZE

Volkswagen VIN Breakdown

Canadian Models

1996 Model Year

WMI

Position	1	2	3
	1	2	3

VDS

4	5	6	7	8
1	2	3	4	5

VIS

10	11	12	13	14	15	16	17
1	2	3	4	5	6	7	8

9

Position No. Block Description

1-3 Mfg Make

Characters Description

WVW	VW - Europe Pass Car
WV1	VW - Europe Truck
WV2	VW - Europe MPV
3VW	VW - Mexico Pass Car

4 Series

2 dr 4 dr

Cabrio	A	
Golf	E	CL
	F	GL/TDI
	D	GII
	H	GII VR6
Jetta	R	GL/TDI
	S	GLS
	T	GLX
Passat	A	GLS/TDI
	B	GLS/TDI
	C	Wagon
	D	GLX Wagon

Position No.

4 Series

Block Description

Characters

3 dr 4 dr

Description

Eurovan	E		Panel Van
	K	L	GLS
	P		CV

5 Engine Type

See Chart

6

Restraint System

0	Active - Dir/Pass
8	AirBag - Dir/Pass
	Active - Dir/Pass

7-8

Model

1E	Carbio
1H	GII / Golf / Jetta
3A	Passat
50	Corrado
70	Eurovan

9

Check Digit

.	*Calculate per NHSTA Code
---	------------------------------

10

Model Year

T	1996
---	------

11

Plant of Mfg.

E	Emden
H	Hanover
K	Osnabrueck
M	Mexico
W	Wolfsburg

12-17

Sequential Production No.

Audi VIN Breakdown

1995 Model Year

WMI

Position	1	2	3
	1	2	3

VDS

4	5	6	7	8
1	2	3	4	5

VIS

9	10	11	12	13	14	15	16	17
	1	2	3	4	5	6	7	8

Position No. Block Description Characters Description

1-3 Mfg. Make WAU Audi - Europe Pass. Car

4 Series

2 Door Models	A	Cabriolet
	B	Cabriolet

4 Door Models	B	90
	C	90 quattro
	D	Sport90
	E	Sport90 quattro
	F	A6
	G	A6 Quattro
	H	A6 Wagon
	J	A6 Quattro Wagon
	K	S6

Position No.

Block Description Characters Description

5 Engine Type See Chart

6 Restraint System 8 AirBag - Dr/Pass Active - Dr/Pass

7-8 Model

4A	A6/S6
8C	90
8G	Cabriolet

9

Check Digit *

*Calculate per NHTSA Code

10

Model Year S

1995

11

Plant of Mfg. A N

Ingolstadt Neckarsulm

12-17

Sequential Product No.

VW/Audi VIN Breakdown

1994 Model Year

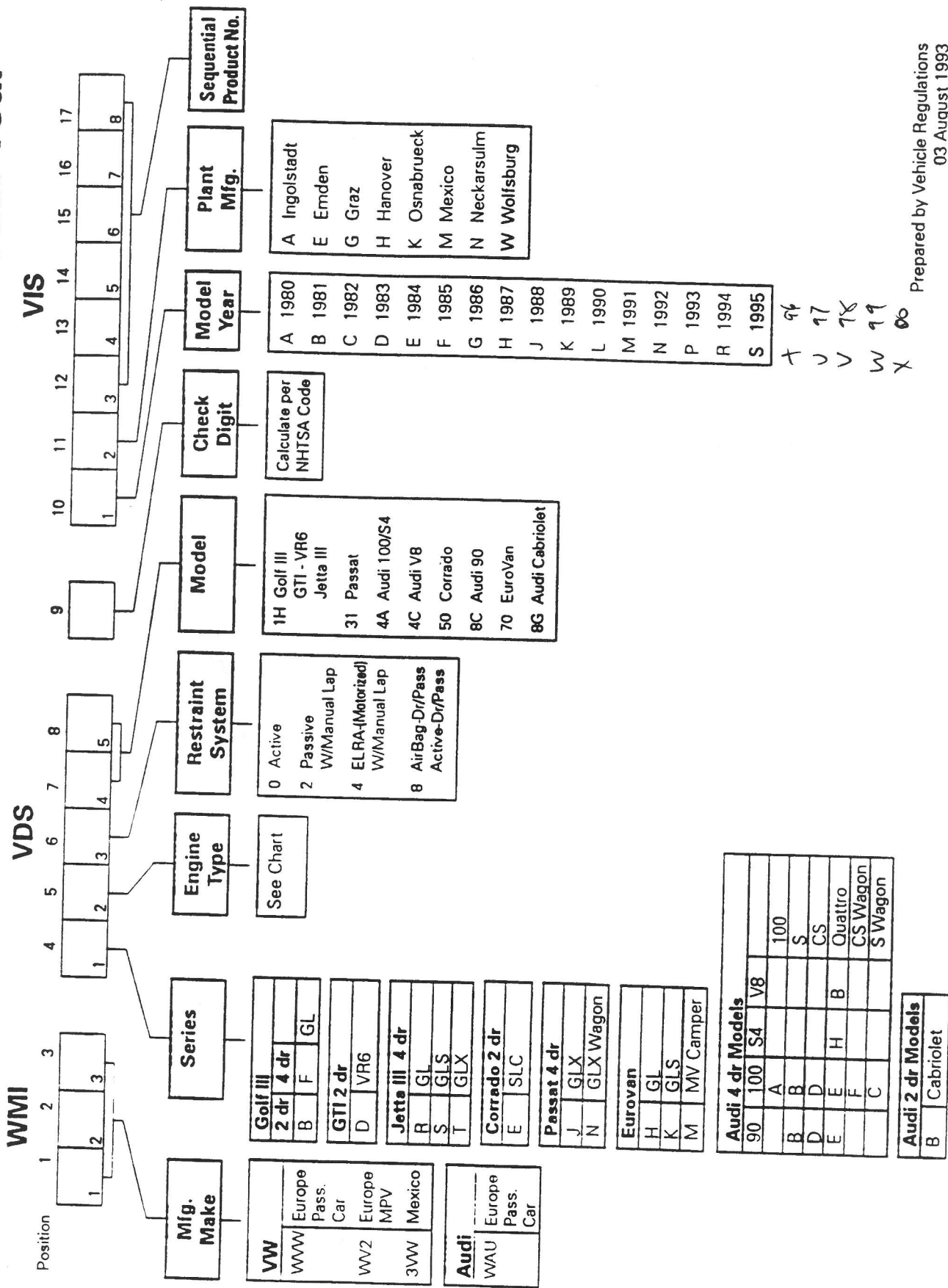

1994 Audi Vehicles

Code	Attributes	Golf III	Golf VR6	Jetta III	Corrado	Passat	EuroVan	Code	Attributes	Audi 90	Audi 100	S4 Quattro	V8 Quattro	Cabriolet
A	Fuel	Gas(49)		Gas(49)				J	Fuel	Gas(49)				
	Cyl.	4		4					Cyl.	6				
	Displ.	1984		1984					Displ.	2771				
	H/P	115		115					H/P	172				
B	Mfg.	VW		VW				K	Mfg.	Audi				
	Fuel	Gas(Cal)		Gas(Cal)					Fuel	Gas(CAL)				
	Cyl.	4		4					Cyl.	6				
	Displ.	1984		1984					Displ.	2771				
C	H/P	115		115				L	H/P	172				
	Mfg.	VW		VW					Mfg.	Audi				
	Fuel								Fuel					
	Cyl.								Cyl.					
D	Displ.							R	Displ.					
	H/P								H/P					
	Mfg.								Mfg.					
	Fuel								Fuel					
E	Cyl.							W	Cyl.					
	Displ.								Displ.					
	H/P								H/P					
	Mfg.								Mfg.					
F	Fuel								Fuel					
	Cyl.								Cyl.					
	Displ.								Displ.					
	H/P								H/P					
L	Mfg.								Mfg.					
	Fuel								Fuel					
	Cyl.								Cyl.					
	Displ.								Displ.					
M	H/P								H/P					
	Mfg.								Mfg.					
	Fuel								Fuel					
	Cyl.								Cyl.					
R	Displ.								Displ.					
	H/P								H/P					
	Mfg.								Mfg.					
	Fuel								Fuel					
S	Cyl.								Cyl.					
	Displ.								Displ.					
	H/P								H/P					
	Mfg.								Mfg.					

VW/Audi VIN Breakdown

1993 Model Year

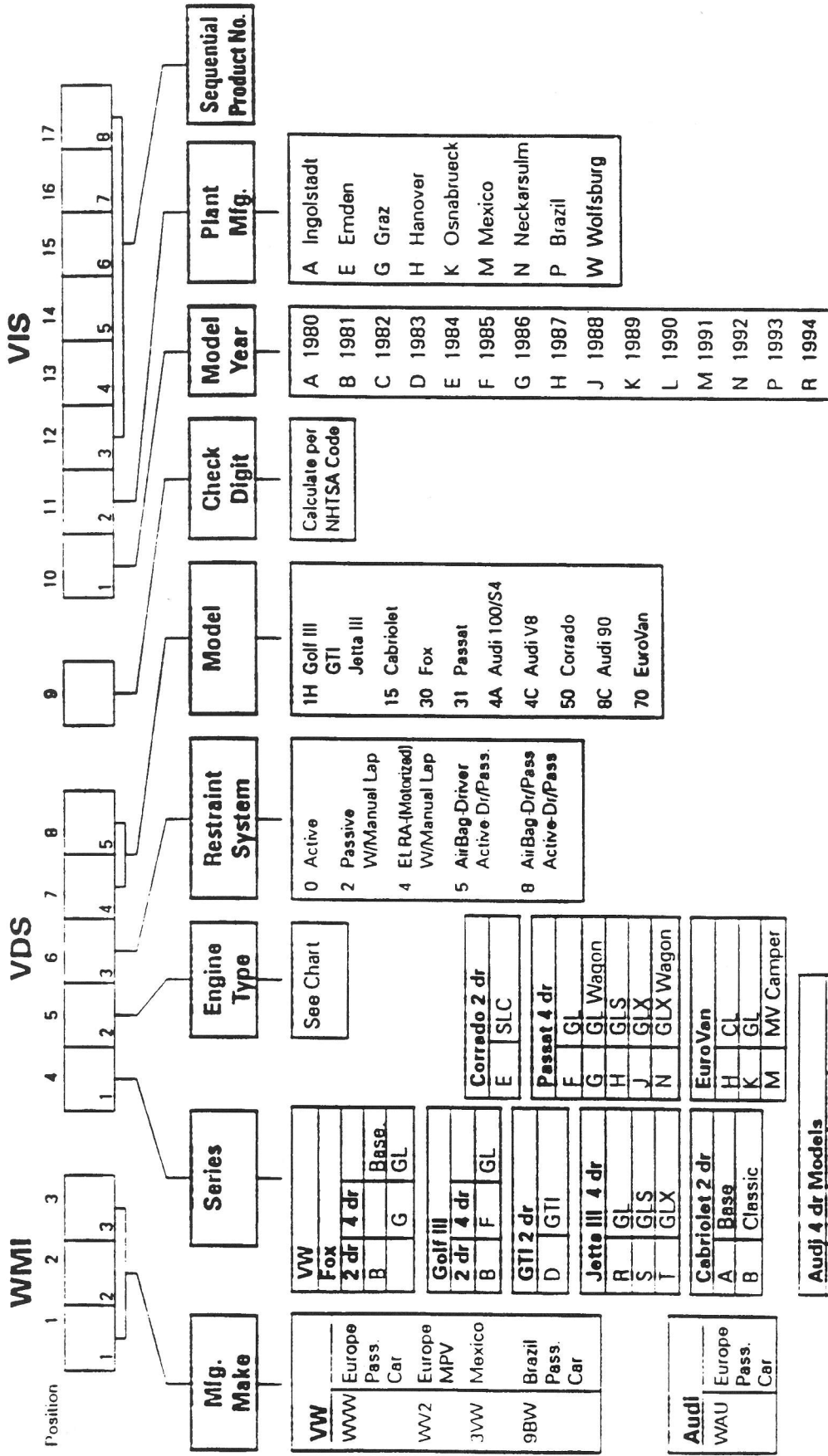

Audi 4 dr Models			
90	100	S4	V8
A			100
B	B		S
D	D		CS
E	E	H	B
F	F		Quattro Wagon

1993 Audi Vehicles

Engine Type - 1993 Volkswagen Vehicles

Code	Attributes	Fox	Golf	Cabriolet	Jetta	Corrado	Passat	EuroVan	Code	Attributes	Audi 90	Audi 100	Audi S4 Quattro	Audi V8 Quattro
A	Fuel Cyl. Displ. H/P Mfg.	Gas(49) 4 1780 81 VW							C	Fuel Cyl. Displ. H/P Mfg.				
B	Fuel Cyl. Displ. H/P Mfg.	Gas(CAL) 4 1780 81 VW		Gas(49) 4 1780 94 VW			Gas(49) 4 1984 134 Audi		D	Fuel Cyl. Displ. H/P Mfg.				
C	Fuel Cyl. Displ. H/P Mfg.			Gas(CAL) 4 1780 94 VW			Gas(CAL) 4 1984 134 Audi	Gas(49) 5 2459 109 VW	J	Fuel Cyl. Displ. H/P Mfg.	Gas(49) 6 2771 172 Audi	Gas(49) 6 2771 172 Audi		
D	Fuel Cyl. Displ. H/P Mfg.					Gas(CAL) 6 2792 178 VW	Gas(49) 6 2792 172 VW	Gas(CAL) 5 2459 109 VW	K	Fuel Cyl. Displ. H/P Mfg.	Gas(CAL) 6 2771 172 Audi	Gas(CAL) 6 2771 172 Audi		
E	Fuel Cyl. Displ. H/P Mfg.					Gas(49) 6 2792 178 VW	Gas(CAL) 6 2792 172 VW		P	Fuel Cyl. Displ. H/P Mfg.			Gas(49) 5 2226 227 Audi	
L	Fuel Cyl. Displ. H/P Mfg.		Gas(49) 4 1984 115 VW		Gas(49) 4 1984 115 VW				R	Fuel Cyl. Displ. H/P Mfg.			Gas(CAL) 5 2226 227 Audi	
M	Fuel Cyl. Displ. H/P Mfg.				Gas(49) 6 2792 172 VW				W	Fuel Cyl. Displ. H/P Mfg.				Gas 8 4200 276 Audi
R	Fuel Cyl. Displ. H/P Mfg.		Gas(CAL) 4 1984 115 VW		Gas(CAL) 4 1984 115 VW									
S	Fuel Cyl. Displ. H/P Mfg.				Gas(CAL) 6 2792 172 VW									

VW/Audi Vin Breakdown

1992 Model Year

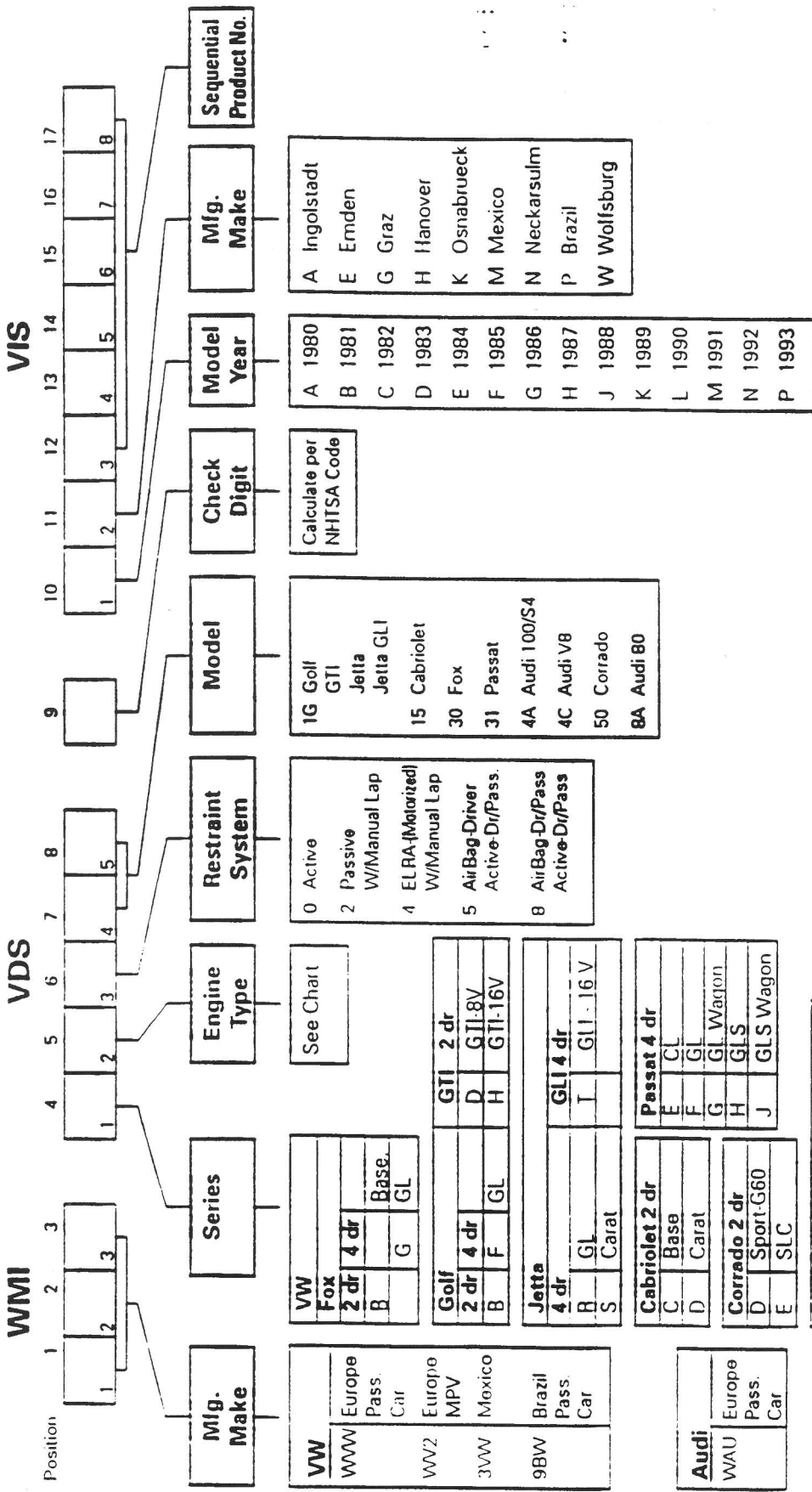

1992 Audi Vehicles

Engine Type - 1992 Volkswagen Vehicles

Code	Attributes	Fox	Golf	Cabriolet	Jetta	Corrado	Passat	Code	Attributes	Audi 80	Audi 100	Audi S4 Quattro	Audi V8 Quattro
A	Fuel	Gas(49)	Gas(49)		Gas(49)			C	Fuel	Gas(49)			
	Cyl. Displ. H/P Mfg.	4 1780 81 VW	4 1780 100 VW		4 1780 100 VW								
B	Fuel	Gas(CAL)	Gas(49)	Gas(49)	Gas(49)	Gas(49)	Gas(49)	D	Fuel	Gas(CAL)			
	Cyl. Displ. H/P Mfg.	4 1780 81 VW	4 1780 105 VW	4 1780 94 VW	4 1780 105 VW	4 1780 158 VW	4 1984 134 Audi						
C	Fuel			Gas(CAL)	Gas(CAL)	Gas(CAL)	Gas(CAL)	J	Fuel		Gas(49)		
	Cyl. Displ. H/P Mfg.			4 1780 94 VW	4 1780 158 VW	4 1780 158 VW	4 1984 134 Audi						
D	Fuel					Gas(49)	Gas(49)	K	Fuel				
	Cyl. Displ. H/P Mfg.					6 2792 178 VW	6 2792 172 VW						
E	Fuel		Gas(49)		Gas(CAL)	Gas(49)	Gas(CAL)	P	Fuel			Gas(49)	
	Cyl. Displ. H/P Mfg.		4 1984 134 Audi		4 1984 134 Audi	6 2792 178 VW	6 2792 172 VW						
F	Fuel				Diesel(49)			R	Fuel			Gas(CAL)	
	Cyl. Displ. H/P Mfg.				4 1588 59 VW								
G	Fuel							V	Fuel				Gas(49)
	Cyl. Displ. H/P Mfg.												
J	Fuel		Gas(CAL)		Gas(49)			W	Fuel				Gas(CAL)
	Cyl. Displ. H/P Mfg.		4 1984 134 Audi		4 1984 134 Audi								
K	Fuel		Gas(CAL)		Gas(CAL)				Fuel				Gas(CAL)
	Cyl. Displ. H/P Mfg.		4 1780 100 VW		4 1780 100 VW								

VW/Audi Vin Breakdown

1991 Model Year

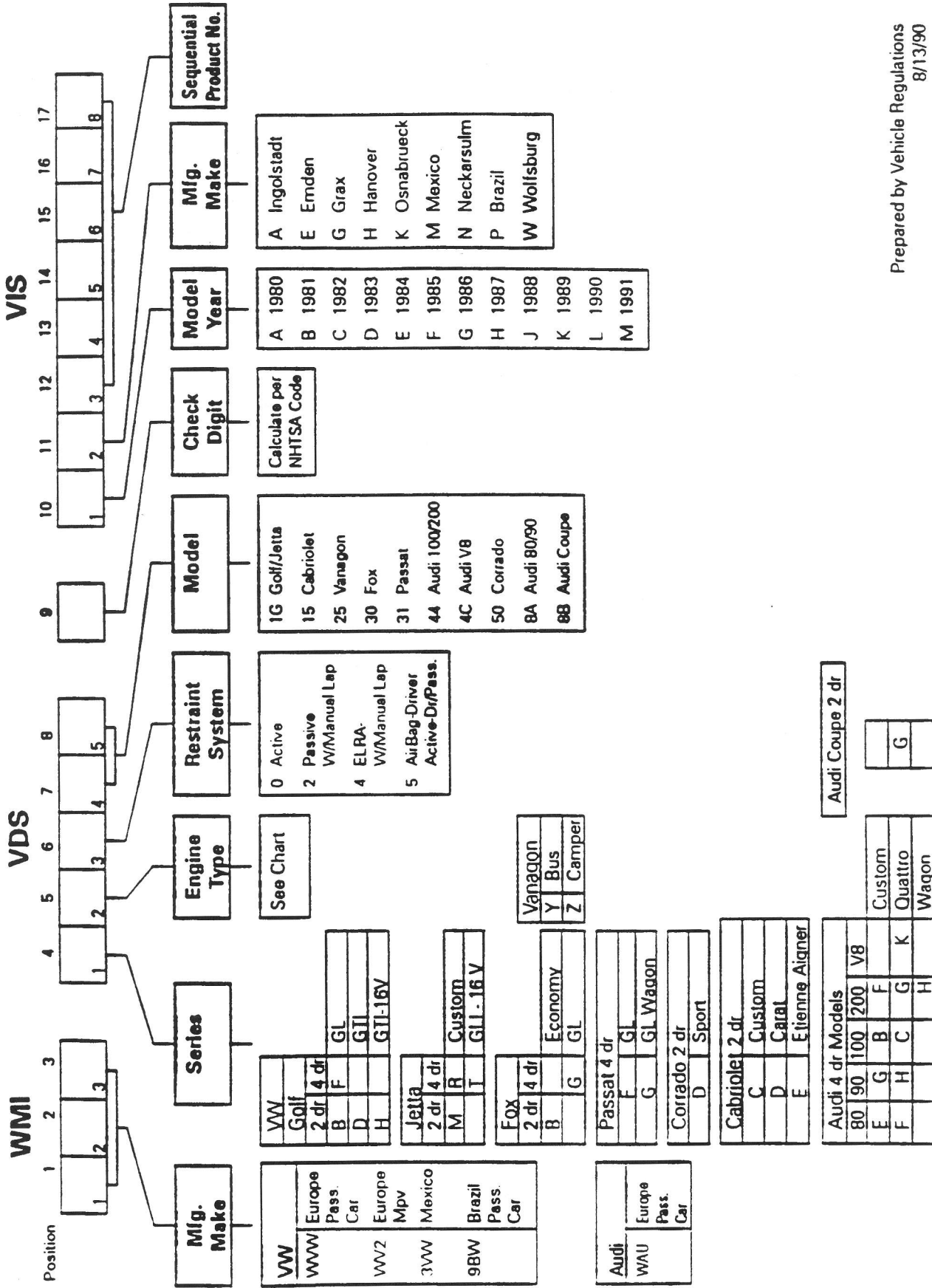

VW/Audi Vin Breakdown

1990 Model Year

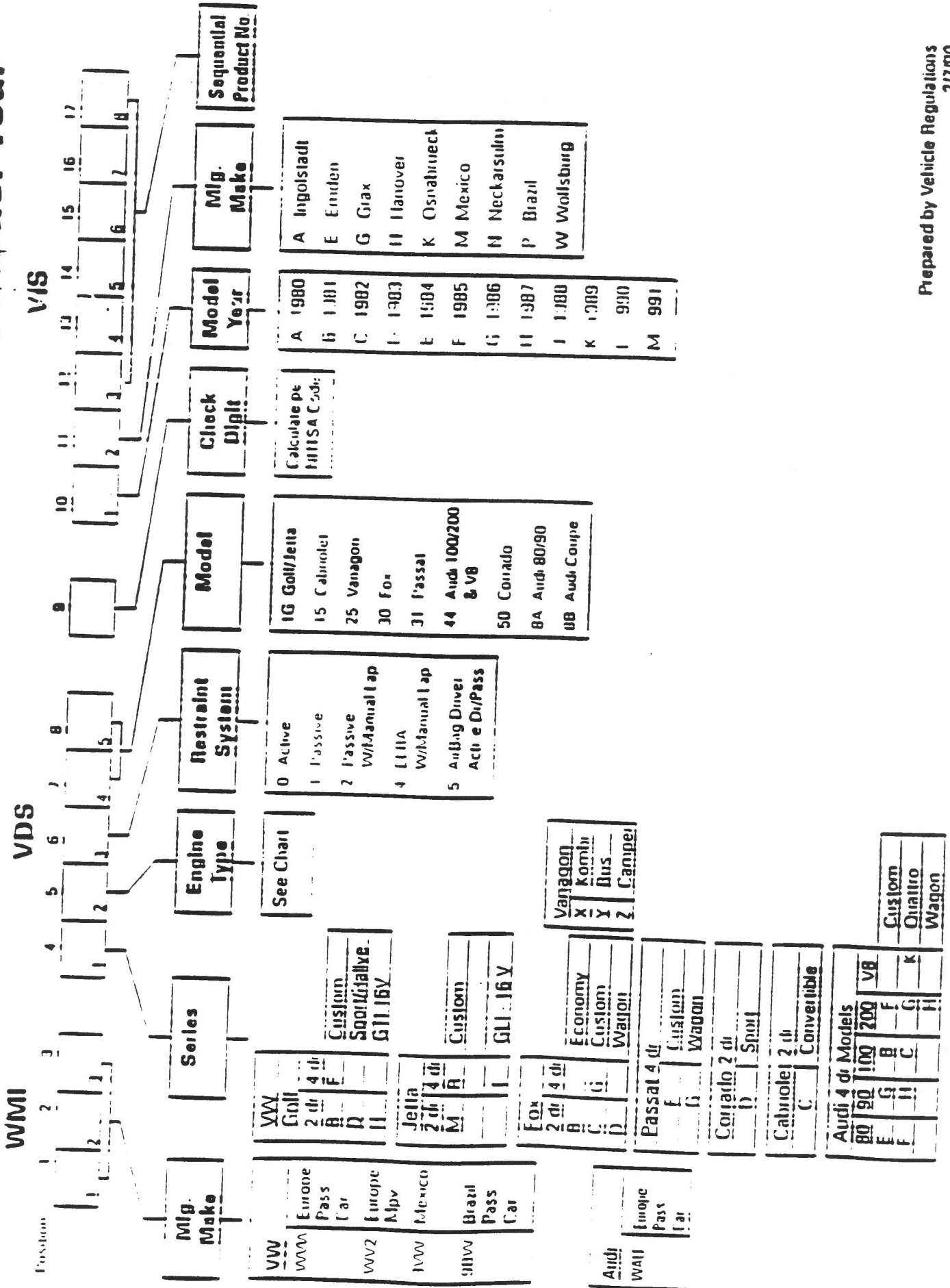

Eng. Type - 1990 VW/Audi Vehicles

Code	Attributes	Fox	Golf	Cabriolet	Jetta	Comado	Passat	Vanagon	Audi 50 Audi P3	Audi Coupe Quattro	Audi 100	Audi 200	Audi V8 Quattro
A	Fuel Cyl. 1780 81 VW Displ. I/P 100 VW Mfg VW	Gas(49) 1780 100 VW Gas(49) 1780 105 VW	Gas(49) 1780 94 VW Gas(49) 1780 100 VW	Gas 1780 94 VW	Gas(49) 1780 105 VW	Gas 1780 158 VW	Gas 1984 134 Audi	Gas 2109 80 VW	Gas(49) 1984 108 Audi Gas(49) 5 2309 130 Audi	Gas 5 2309 164 Audi	Gas 5 2309 130 Audi	Gas 5 2228 182 Audi	Gas 8 3562 240 Audi
B	Fuel Cyl. 1780 81 VW Displ. I/P 100 VW Mfg VW	Gas(49) 1780 81 VW	Gas(49) 1780 105 VW	Gas 1780 105 VW	Gas(49) 1780 105 VW	Gas 1780 158 VW	Gas 1984 134 Audi	Gas 2109 80 VW	Gas(49) 1984 108 Audi	Gas 5 2309 164 Audi	Gas 5 2309 130 Audi	Gas 5 2228 182 Audi	Gas 8 3562 240 Audi
C	Fuel Cyl. 1780 81 VW Displ. I/P 100 VW Mfg VW	Gas(49) 1780 81 VW	Gas(49) 1780 105 VW	Gas 1780 105 VW	Gas(49) 1780 105 VW	Gas 1780 158 VW	Gas 1984 134 Audi	Gas 2109 80 VW	Gas(49) 1984 108 Audi	Gas 5 2309 164 Audi	Gas 5 2309 130 Audi	Gas 5 2228 182 Audi	Gas 8 3562 240 Audi
D	Fuel Cyl. 1780 81 VW Displ. I/P 100 VW Mfg VW	Gas(49) 1780 81 VW	Gas(49) 1780 105 VW	Gas 1780 105 VW	Gas(49) 1780 105 VW	Gas 1780 158 VW	Gas 1984 134 Audi	Gas 2109 80 VW	Gas(49) 1984 108 Audi	Gas 5 2309 164 Audi	Gas 5 2309 130 Audi	Gas 5 2228 182 Audi	Gas 8 3562 240 Audi
E	Fuel Cyl. 1780 81 VW Displ. I/P 100 VW Mfg VW	Gas(49) 1780 81 VW	Gas(49) 1780 105 VW	Gas 1780 105 VW	Gas(49) 1780 105 VW	Gas 1780 158 VW	Gas 1984 134 Audi	Gas 2109 80 VW	Gas(49) 1984 108 Audi	Gas 5 2309 164 Audi	Gas 5 2309 130 Audi	Gas 5 2228 182 Audi	Gas 8 3562 240 Audi
F	Fuel Cyl. 1780 81 VW Displ. I/P 100 VW Mfg VW	Gas(49) 1780 81 VW	Gas(49) 1780 105 VW	Gas 1780 105 VW	Gas(49) 1780 105 VW	Gas 1780 158 VW	Gas 1984 134 Audi	Gas 2109 80 VW	Gas(49) 1984 108 Audi	Gas 5 2309 164 Audi	Gas 5 2309 130 Audi	Gas 5 2228 182 Audi	Gas 8 3562 240 Audi
G	Fuel Cyl. 1500 52 VW Displ. I/P 100 VW Mfg VW	Diesel(49) 1500 52 VW	Diesel(49) 1500 52 VW	Gas 1780 100 VW	Diesel(49) 1500 52 VW	Gas 1780 158 VW	Gas 1984 134 Audi	Gas 2109 80 VW	Gas(49) 1984 108 Audi	Gas 5 2309 164 Audi	Gas 5 2309 130 Audi	Gas 5 2228 182 Audi	Gas 8 3562 240 Audi
J	Fuel Cyl. 1984 134 Audi Displ. I/P 100 VW Mfg Audi	Gas(49) 1984 134 Audi	Gas(49) 1984 134 Audi	Gas 1780 100 VW	Gas(49) 1984 134 Audi	Gas 1780 158 VW	Gas 1984 134 Audi	Gas 2109 80 VW	Gas(49) 1984 108 Audi	Gas 5 2309 164 Audi	Gas 5 2309 130 Audi	Gas 5 2228 182 Audi	Gas 8 3562 240 Audi
K	Fuel Cyl. 1780 100 VW Displ. I/P 100 VW Mfg VW	Gas(49) 1780 100 VW	Gas(49) 1780 100 VW	Gas 1780 100 VW	Gas(49) 1780 100 VW	Gas 1780 158 VW	Gas 1984 134 Audi	Gas 2109 80 VW	Gas(49) 1984 108 Audi	Gas 5 2309 164 Audi	Gas 5 2309 130 Audi	Gas 5 2228 182 Audi	Gas 8 3562 240 Audi

1989 MODEL YEAR VW/AUDI VIN BREAKDOWN

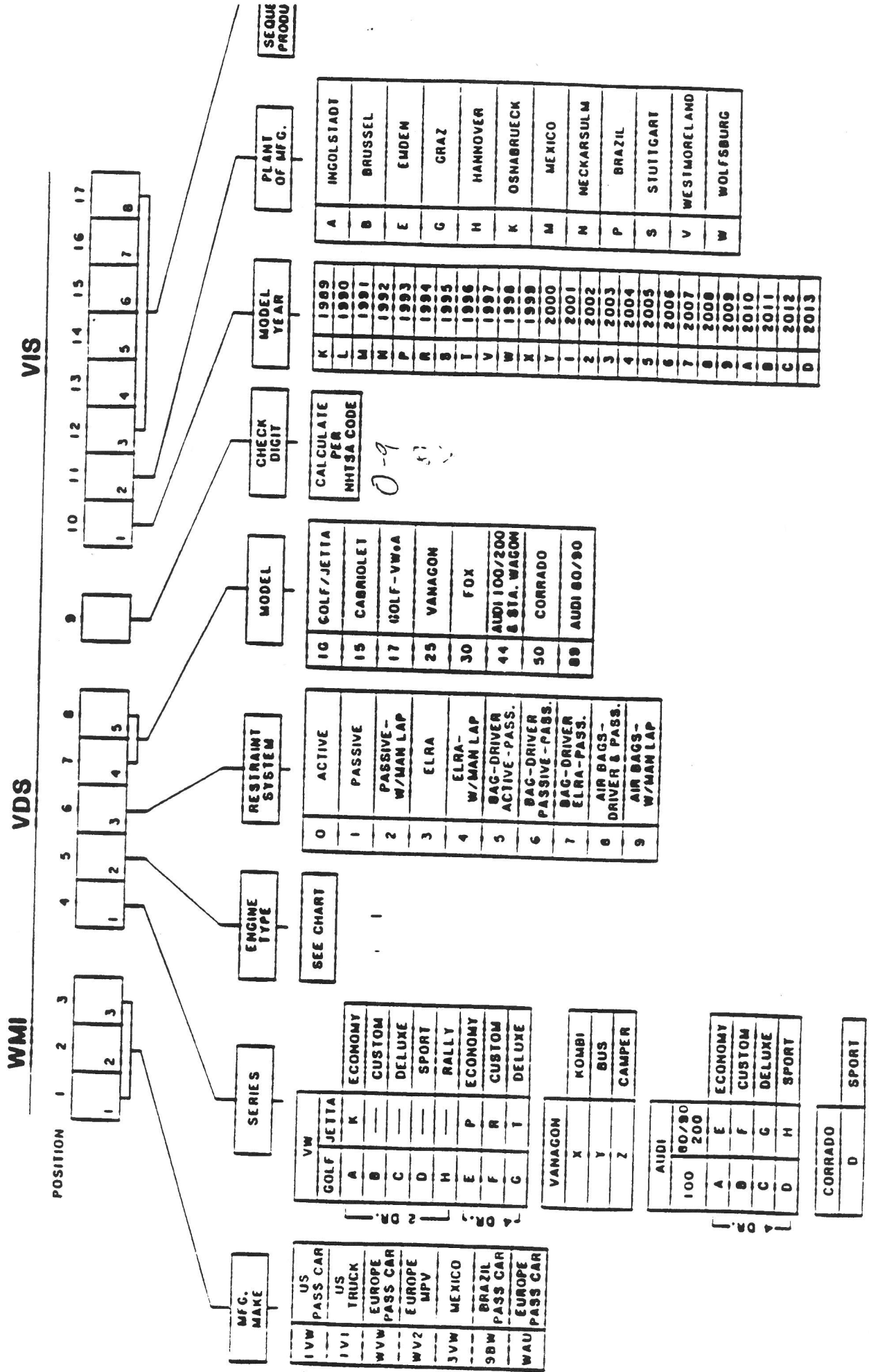

WMI

VDS

VIS



MFG. MAKE

1VW	US PASS CAR
1VI	US TRUCK
WVW	EUROPE PASS CAR
WV2	EUROPE MPV
3VW	MEXICO
9BW	BRAZIL PASS CAR
WAW	EUROPE PASS CAR

SERIES

VW	GOLF	JETTA
A	ECONOMY	
B	CUSTOM	
C	DELUXE	
D	SPORT	
H	RALLY	
E	ECONOMY	
F	CUSTOM	
G	DELUXE	

ENGINE TYPE

SEE CHART

RESTRAINT SYSTEM

0	ACTIVE
1	PASSIVE
2	PASSIVE - W/MAN LAP
3	ELRA
4	ELRA - W/MAN LAP
5	BAG-DRIVER ACTIVE - PASS.
6	BAG-DRIVER PASSIVE - PASS.
7	BAG-DRIVER ELRA - PASS.
8	AIR BAGS - DRIVER & PASS.
9	AIR BAGS - W/MAN LAP

MODEL

10	GOLF/JETTA
15	CABRIOLET
17	GOLF-VW/A
25	VANAGON
30	FOX
44	AUDI 100/200 & STA. WAGON
50	CORRADO
89	AUDI 80/90

CHECK DIGIT

CALCULATE PER NHTSA CODE

0-9

MODEL YEAR

K	1989
L	1990
M	1991
N	1992
P	1993
R	1994
S	1995
T	1996
V	1997
W	1998
X	1999
Y	2000
1	2001
2	2002
3	2003
4	2004
5	2005
6	2006
7	2007
8	2008
9	2009
A	2010
B	2011
C	2012
D	2013

PLANT OF MFG.

A	INGOLSTADT
B	BRUSSEL
E	EMDEN
G	GRAZ
H	HAMNOVER
K	OSNABRUECK
M	MEXICO
N	NECKARSULM
P	BRAZIL
S	STUTTGART
V	WESTMORELAND
W	WOLFSBURG

1988 MODEL YEAR

VW/AUDI VIN BREAKDOWN

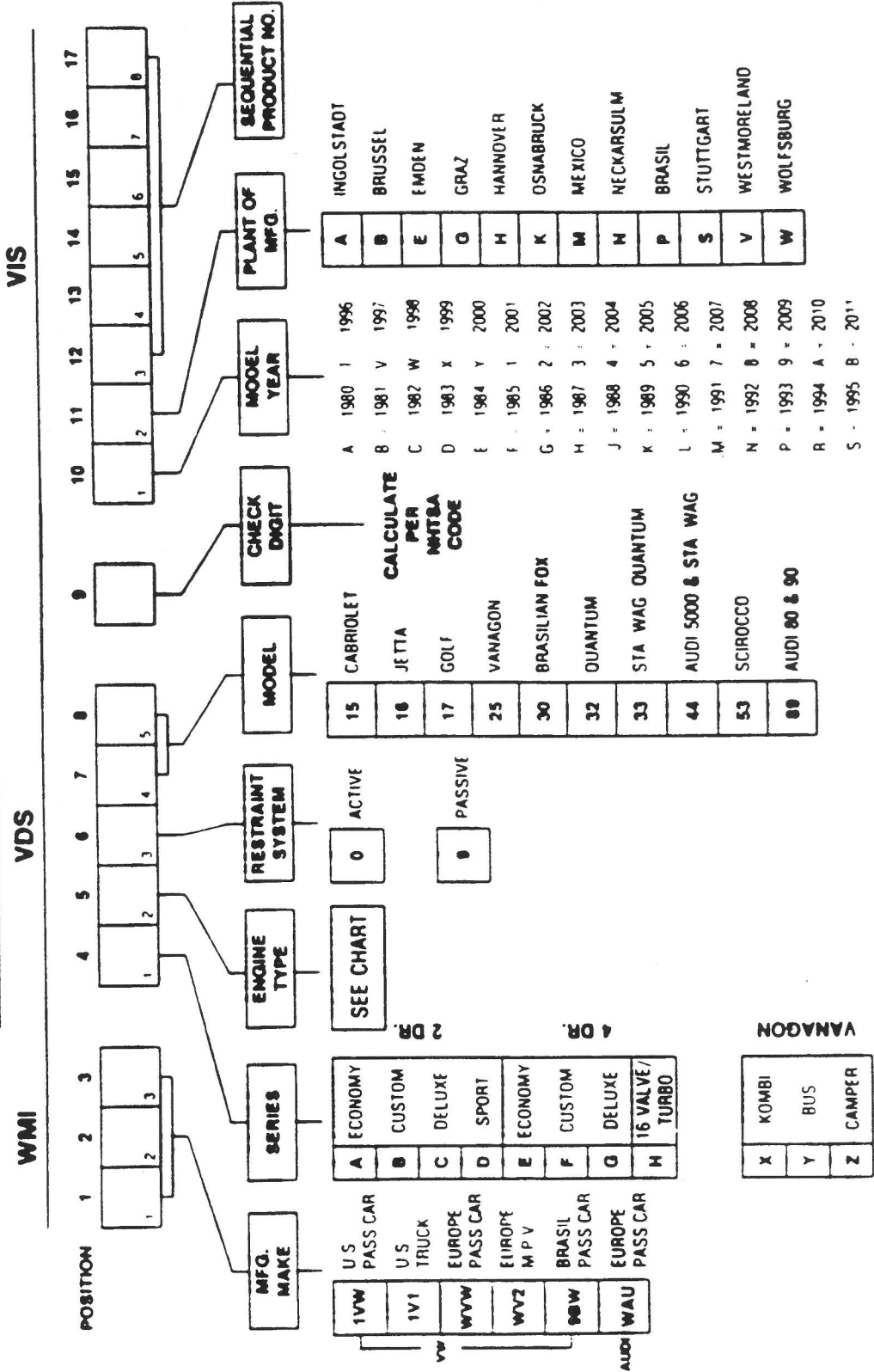

PREPARED BY
VEHICLE REGULATIONS

1987 MODEL YEAR

VW/AUDI VIN BREAKDOWN

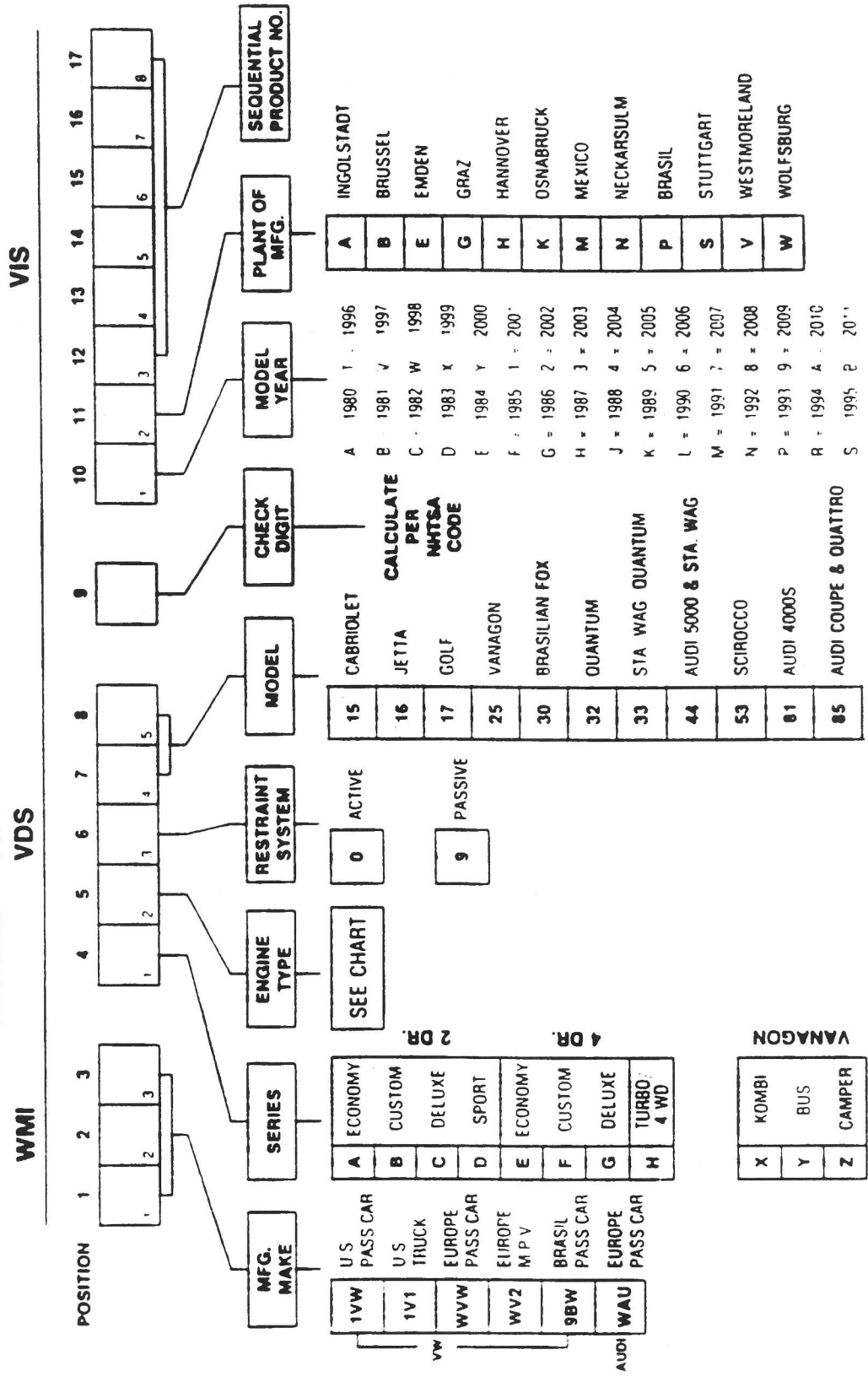

PREPARED BY
VEHICLE REGULATIONS

ENGINE TYPE

CODE	ATTRIBUTES	GOLF	CABRIOLET	JETTA	SCIROCCO	QUANTUM QUANTUM SYNCR0	VANAGON	BRASIL FOX	AUDI 4000S	AUDI	AUDI **
A	FUEL CYL. DISPL. H/P MFG.	GAS 4 1780 85 VW0A	GAS 4 1781 90 VW	GAS 4 1781 85 VW	GAS 4 1781 90 VW			GAS 4 1781 85 VW0B			
B	FUEL CYL. DISPL. H/P MFG.	GAS 4 1780 102 VW0A	GAS 4 1781 102/105 VW	GAS 4 1781 102/105 VW	GAS 4 1781 123 VW	GAS 5 2226 110/115 VW	GAS 4 2109 90 VW	GAS 4 1780 102 VW	GAS 5 2226 115 VW	GAS 5 2206 110 VW	GAS
C	FUEL CYL. DISPL. H/P MFG.	GAS 4 1780 123 VW0A		GAS 4 1781 123 VW					GAS 5 2226 115 VW	GAS 5 2300 130 VW	GAS
D	FUEL CYL. DISPL. H/P MFG.									GAS 5 2226 110 VW	GAS T
E	FUEL CYL. DISPL. H/P MFG.									GAS 5 2226 110 VW	GAS T Q
G	FUEL CYL. DISPL. H/P MFG.	DIESEL 4 1588 52 VW0A								GAS 5 2300 130 VW	GAS T Q

★ INCLUDES 4000 QUATTRO, COUPE, AND QUATTRO

★★ T = TURBO Q = QUATTRO

1986 MODEL YEAR

VW/AUDI VIN BREAKDOWN

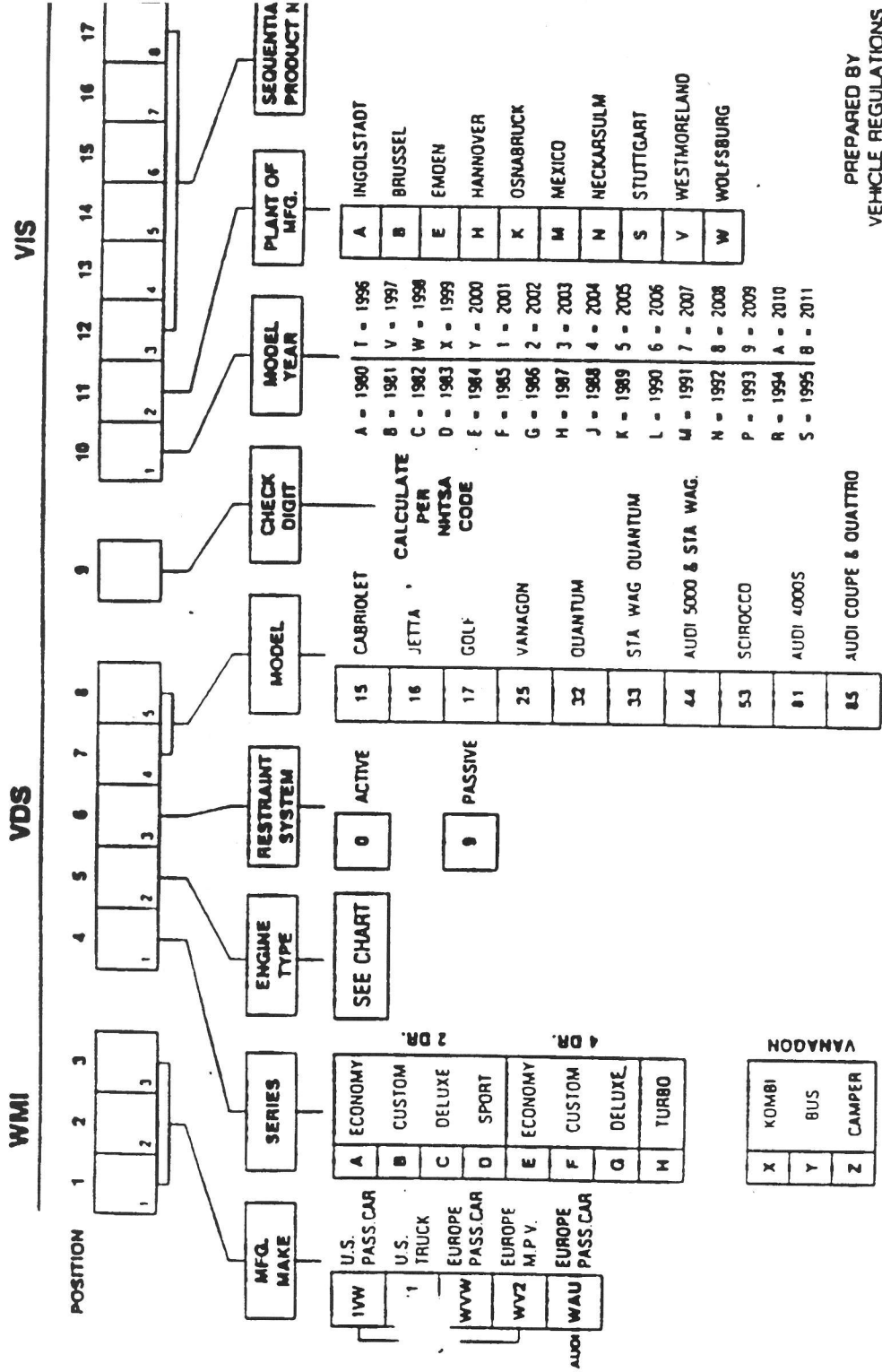

PREPARED BY
VEHICLE REGULATIONS

1985 MODEL YEAR

VW/AUDI VIN BREAKDOWN

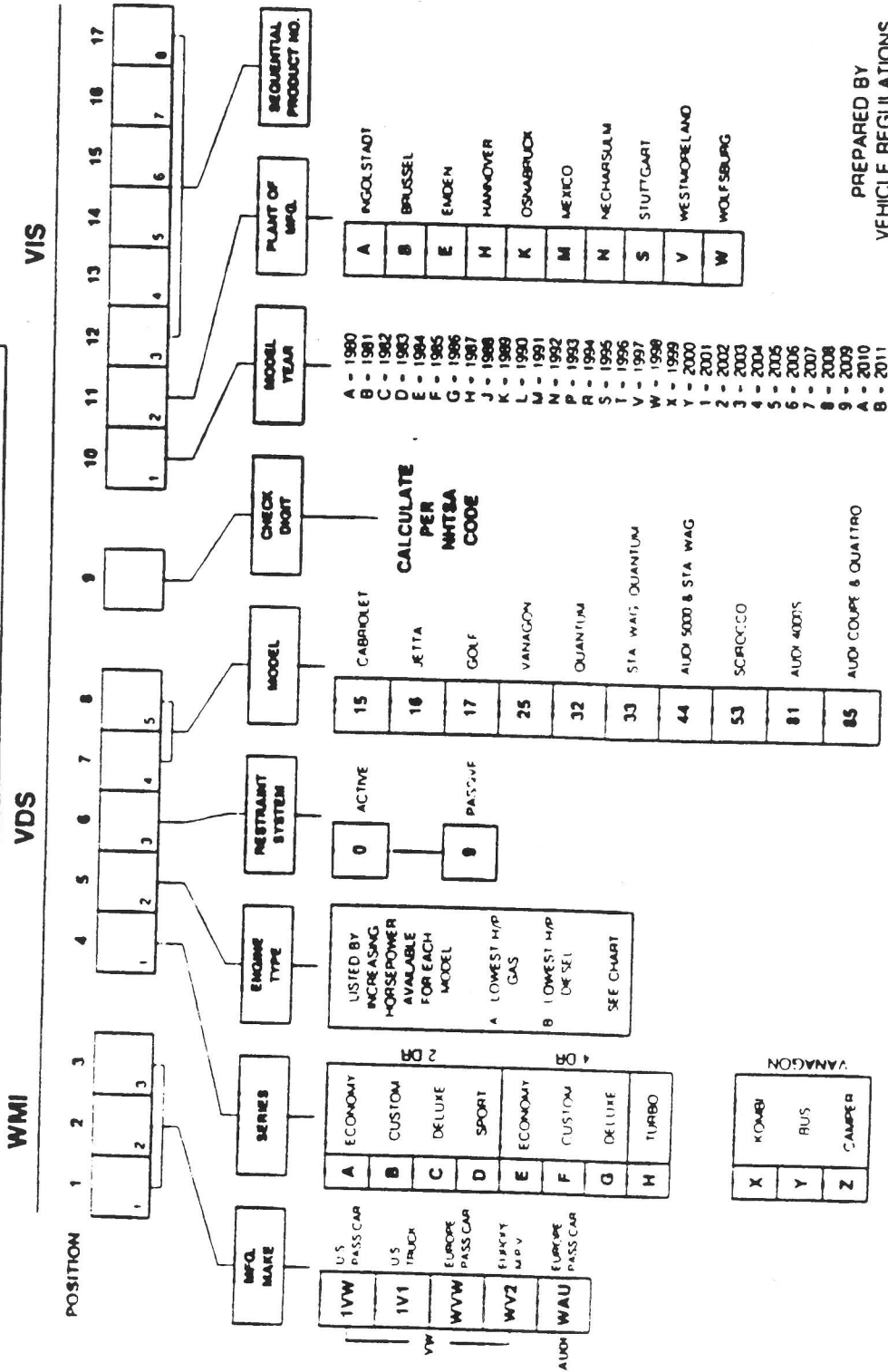

PREPARED BY
VEHICLE REGULATIONS

ENGINE TYPE

CODE	ATTRI-BUTES	GOLF	CONVERT	JETTA	SCIROCCO	QUANTUM	AUDI 4000S	AUDI *	AUDI 5000S	VANAGON
A	FUEL	GAS	GAS	GAS	GAS	GAS				
	CYL.	4	4	4	4	4				
	DISPL	1780	1780	1781	1780	1780				
	H/P	85	90	86	90	88				
B	MFG.	VW	VW	VW	VW	VW				
	FUEL	GAS		GAS		GAS	GAS	GAS	GAS	GAS
	CYL.	4		4		5	4	5	5	4
	DISPL	1781		1780		2226	1780	2226	2220	1915
C	H/P	100		100		110	100	115	110	82
	MFG.	VW		VW		VW	VW	VW	VW	VW
	FUEL						GAS	GAS	GAS	
	CYL.						5	5	5	
D	DISPL						2226	2144	2144	
	H/P						110	160	160	
	MFG.						VW	VW	VW	
	FUEL							GAS		
G	CYL.							5		
	DISPL							2226		
	H/P							110		
	MFG.							VW		
H	FUEL	DIESEL		DIESEL						T-DIESEL
	CYL.	4		4						5
	DISPL	1588		1588						1986
	H/P	52		52						84
	MFG.	VW		VW						VW
	FUEL			T-DIESEL		T-DIESEL				
	CYL.			4		4				
	DISPL			1588		1588				
	H/P			67		68				
	MFG.			VW		VW				

* INCLUDES 4000 QUATTRO, COUPE, AND QUATTRO

1984 MODEL YEAR

VW/AUDI VIN BREAKDOWN

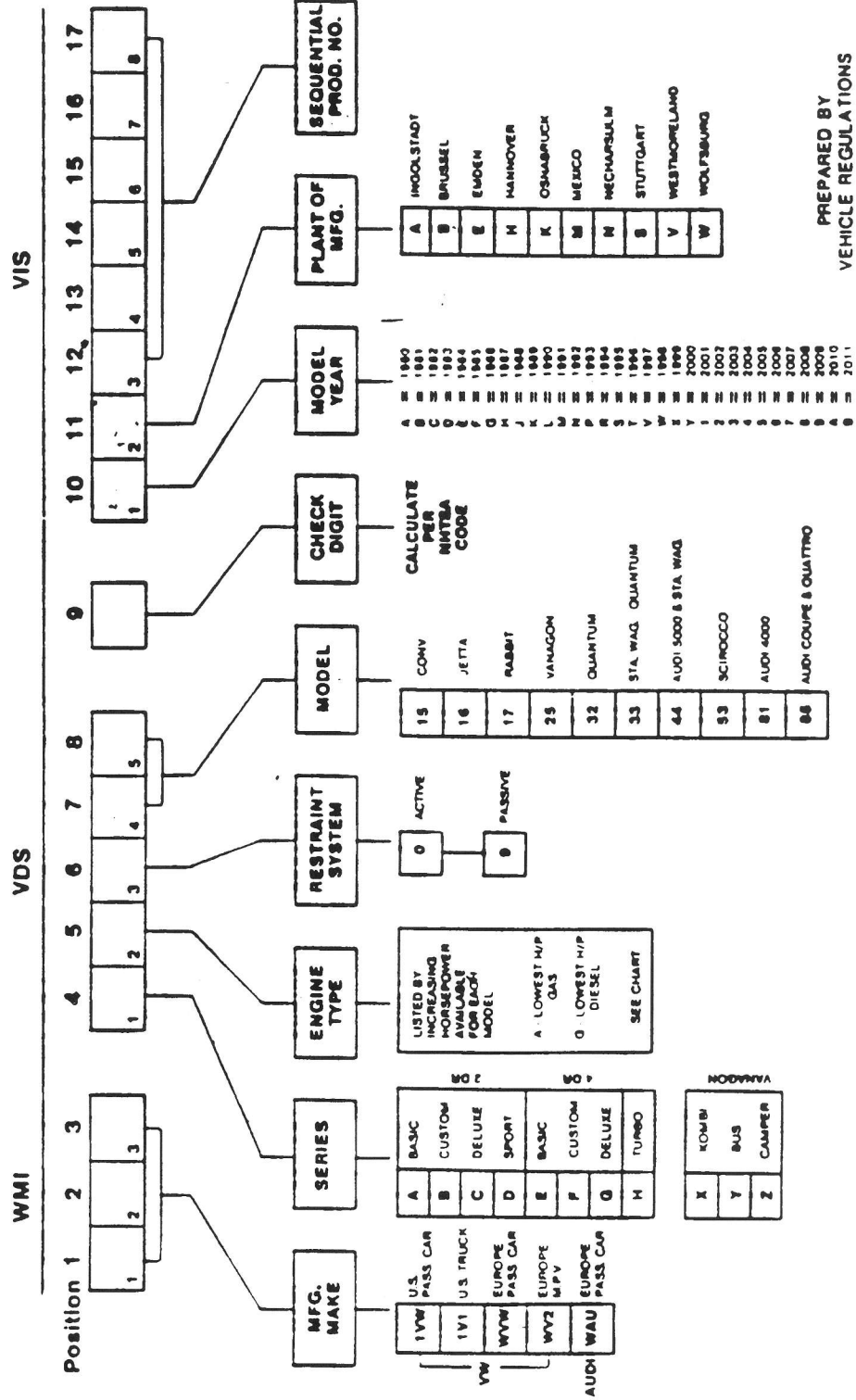

PREPARED BY
VEHICLE REGULATIONS

1983 MODEL YEAR

VW/AUDI VIN BREAKDOWN

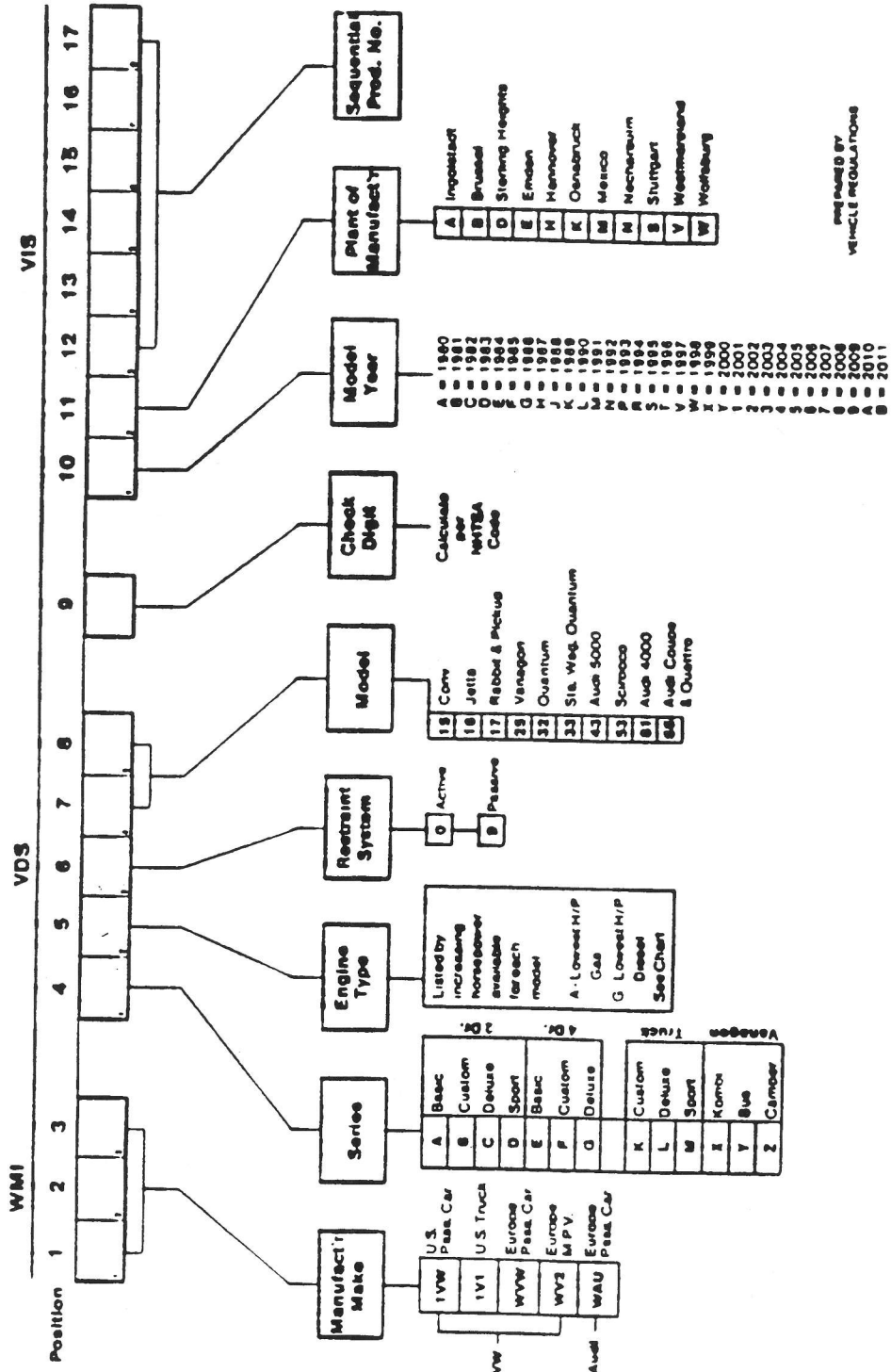

REGULATED BY
VEHICLE REGULATIONS

ENGINE TYPE

CODE	ATTRIBUTES	RABBIT	PICKUP	CONV.	VANAGON	JETTA	QUANTUM	SCIROCCO	AUDI 4000	AUDI 5000	AUDI COUPE & QUATTRO
A	FUEL	GAS		GAS	GAS	GAS	GAS	GAS	GAS		
	CYL	4		4	4	4	4	4	4		
	DISPL	1715		1970	1715	1715	1715	1715	1715		
	H/P	85		87	74	74	74	74	74		
	MFG	VW		VWAG	VWAG	VWAG	VWAG	VWAG	VWAG		
B	FUEL	GAS		GAS	GAS	GAS	GAS		GAS		GAS
	CYL	4		4	4	4	5		5		5
	DISPL	1715		1815	2144	2144	2144		2144		2144
	H/P	74		78	100	100	100		100		100
	MFG	VW		VWAG	VWAG	VWAG	VWAG		VWAG		VWAG
C	FUEL	GAS									
	CYL	4									
	DISPL	1800									
	H/P	80									
	MFG	VW									
G	FUEL	DIESEL			DIESEL	DIESEL	DIESEL		DIESEL		DIESEL
	CYL	4		4	4	4	4		4		5
	DISPL	1800		1500	1800	1800	1800		1800		1800
	H/P	82		48	82	82	82		82		87
	MFG	VW		VWAG	VWAG	VWAG	VWAG		VWAG		VWAG
H	FUEL	DIESEL				DIESEL	DIESEL		DIESEL		DIESEL
	CYL	4		4	4	4	4		4		5
	DISPL	1800		1800	1800	1800	1800		1800		1800
	H/P	88		87	88	88	88		88		84
	MFG	VW		VWAG	VWAG	VWAG	VWAG		VWAG		VWAG

1982 MODEL YEAR

VW / AUDI VIN BREAKDOWN

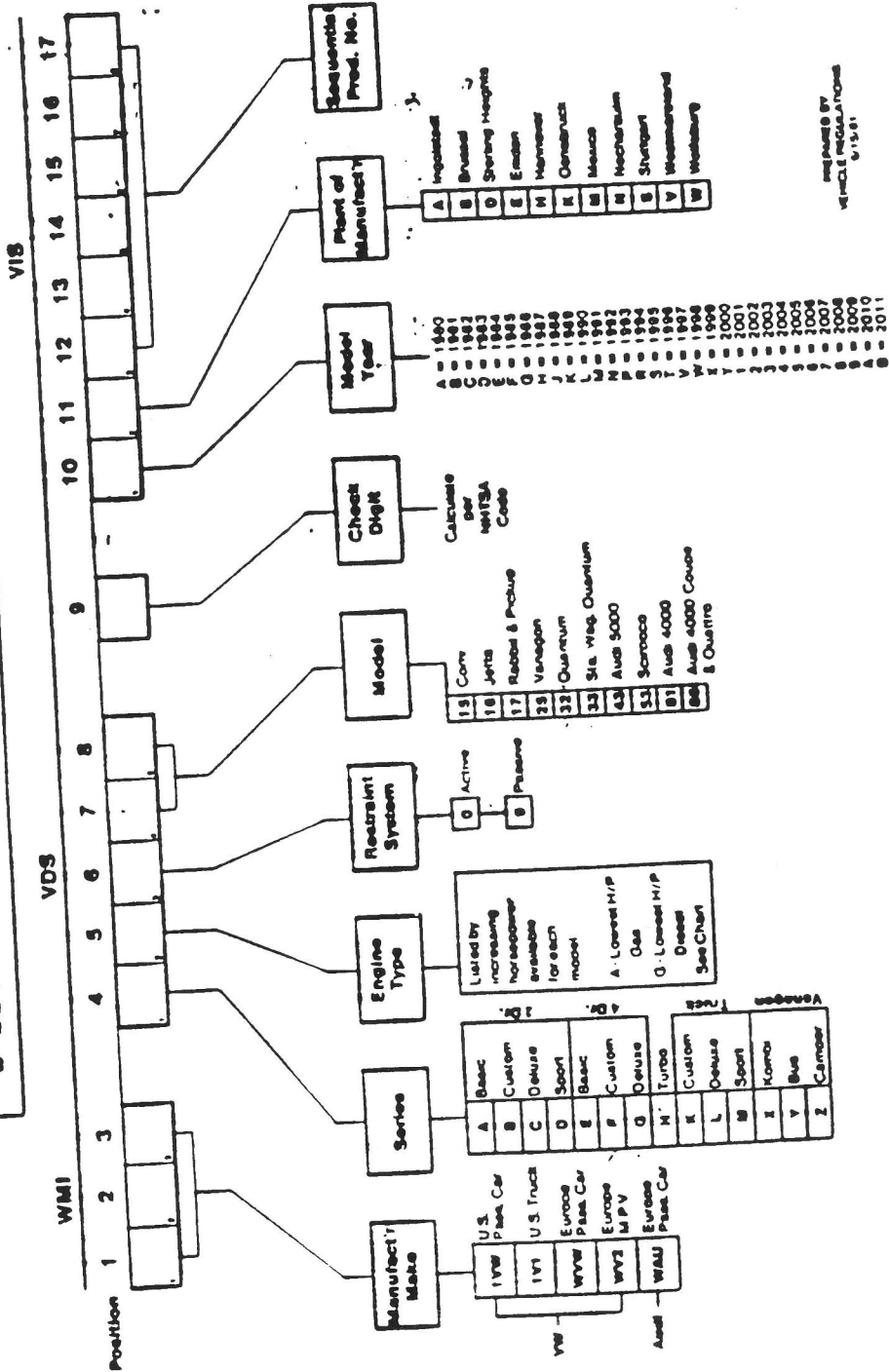

VW/AUDI VIN BREAKDOWN

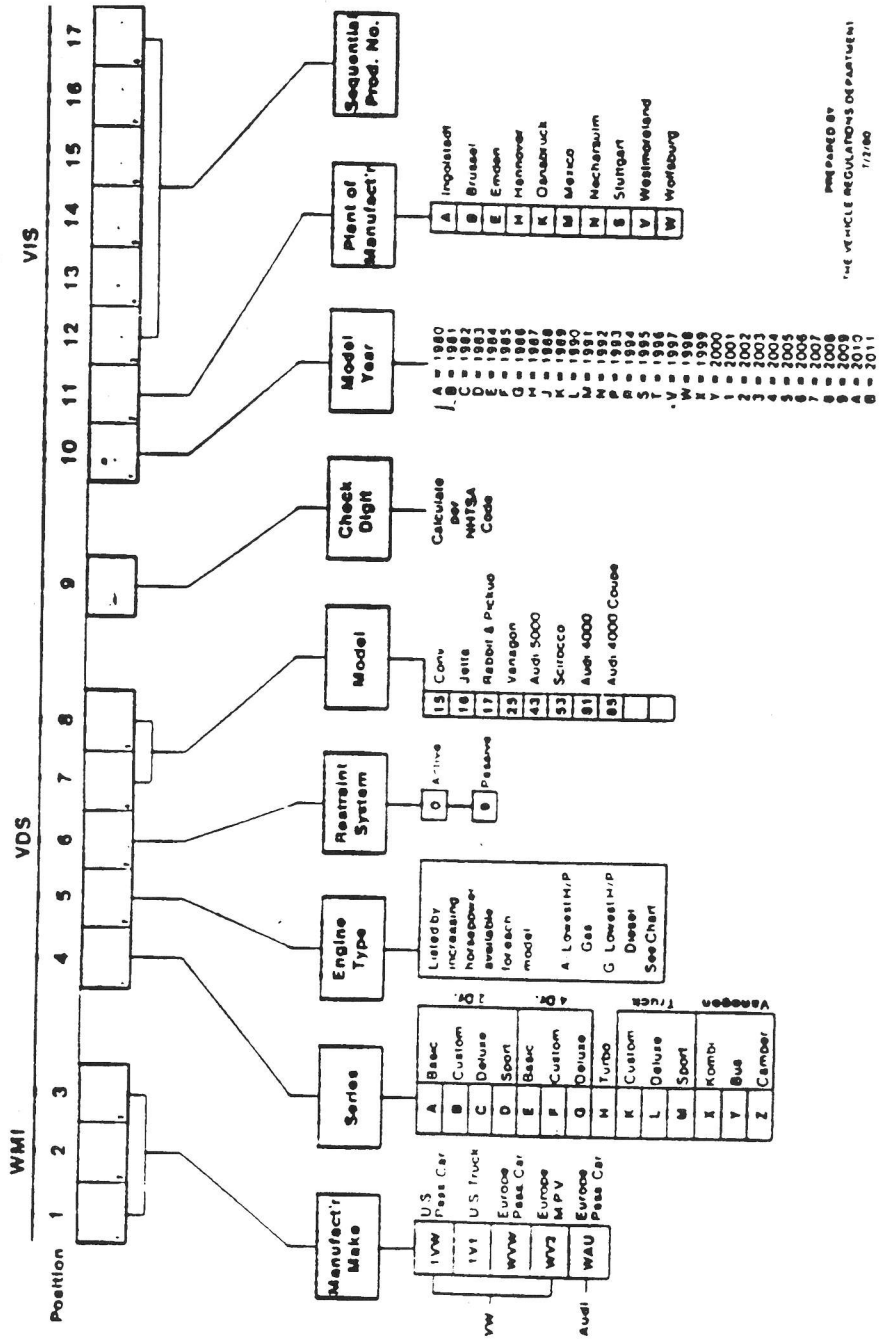

PREPARED BY
THE VEHICLE REGULATIONS DEPARTMENT
1/12/80

1981