

# Volkswagen Campmobile



1979



It goes on vacation with you



## CONTENTS

Battery charging	21	— Deluxe Campmobile with Pop-up Roof	5, 18–24	Pop-up roof	16, 17
Bed, double	7, 17			Refrigerator	19
Bench (rear)	7			Screen, rear lid	16
Ceiling cabinet	8	Fire extinguisher	22	Sink cabinet	10
Ceiling lamp	9	Floor plan	30	Sliding door	12
City water connection	18			Spare wheel	12
Cleaning	29	Gas range	22	Storage box/trash container	24
Clothes closet	8	Hammock, child's	15	Storage chest	11
Curtains	14	Hints (what to take along)	29	Storage locker	6
				Swivel seat	18
Dimensions diagrams	30–31	Icebox	11	Table (dinette)	6
Dinette table	6	Identification plate	8	Table in driver's cabin	24
Double bed	7, 17	Introduction	3		
				Trash container/storage box	24
Electrical network	9			Utensil drawers	10
Equipment		Linen closet	8	Water-tank and pump	18
— Basic Equipment	4, 6–15	Louvered windows	14	What to take along	20
— Campmobile with Pop-up Roof	5, 16, 17	Luggage rack	17	Windows, louvered	14



WELCOME to the growing family of VW Campmobile owners!

You now own a Volkswagen for day-to-day driving and a comfortable home away from home for camping outdoors. Safe dependable transportation, custom equipped for recreation and fun.

The VW Campmobile looks like a VW Station Wagon. And it IS a VW Station Wagon at heart. Your Type 2 Owner's Manual explains everything you should know about the Volkswagen Station Wagon. Be sure to read the Owner's Manual to learn how to operate your Volkswagen safely.

On the following pages, you'll see what makes your VW Station Wagon a Campmobile. We'll tell you all about the equipment in your Campmobile and how to use it. Take a few minutes to read this manual and make yourself at home — — literally.

The descriptions and specifications in this manual are based on product information available at the time of publication. It has always been the manufacturer's policy to continuously make improvements; therefore, the right is reserved to make changes at any time during the model year without notice. Check with your authorized VW dealer on latest product options or accessories.



## CAMPMOBILE EQUIPMENT

You had many options to choose from. Whatever you decided on, you have the basic Campmobile equipment and possibly one or more option packages.

Following is a list of all available Campmobile equipment. Later, we'll explain how to use each item.

**Many of the special-purpose items in your Campmobile are designed for use at the campsite and should not be used while the vehicle is in motion.**

### 1. Basic Equipment

- Rotating dinette table with extension leaf (top is mar-proof and heat-resistant)
- Rear bench seat converting to double bed, with storage locker below.
- Rear deck mattress covering engine compartment.
- Swivel seat.
- Clothes closet with vanity mirror.
- Ceiling cabinet.
- Linen closet.
- Transistorized 12-Volt fluorescent ceiling lamp.
- 110–125 Volt A.C. electrical hook-up receptacle on outside of vehicle. Double outlets, master switch and circuit breaker on kick panel under rear bench.
- Curtains for all windows, including windshield.
- Louvered windows in left side wall and sliding door.
- Cabinet with stainless steel sink, 12-Volt water pump, 26 liters (7 gallons) water tank drawers and storage compartments.
- 33 liters (1.1 cu. ft.) icebox, with polyester insulation, ice rack and separate drain.
- Storage chest.
- Child's hammock.
- Rear luggage compartment lid screen.
- Ceiling and walls insulated and panelled. Floor covered with loop pile carpeting.
- Two assist straps.
- Color-coordinated cloth covers for mattresses and upholstery.
- Safety belts for four seating positions (2 combination lap/shoulder belts for the front and two lap belts for the rear bench seat).
- Spare wheel (stored in right section of sink cabinet).



## OPTIONAL EQUIPMENT

In addition to the Basic Campmobile Equipment, the following are the optional equipment combinations:

### 2. Campmobile with Pop-Up Roof

This option includes all the basic equipment plus the following items:

- Pop-Up Roof with weather-resistant canvas sides and fiberglass-reinforced polyester top. Front wall has a screened window with zippered flap.
- Luggage rack of fiberglass-reinforced polyester with buffer rods and tie-down hooks. The rack can be easily reached from inside the Pop-Up Roof.
- 1.8x 1.2 m (6' x 3' 10") foam rubber double bed with cloth covers in Pop-Up Roof for two adults.

### 3. Deluxe Campmobile with Pop-Up Roof

This is the most comprehensive option and includes all of the above items plus the following:

- City water hook-up.
- 33 liters (1.1 cu. ft.) 12-Volt refrigerator.
- 110-Volt A.C. to 12-Volt D.C. converter for refrigerator operation and battery charging.

- Gas range, with refillable gas tank and hook up \*
- Small dry chemical fire extinguisher. \*
- Upholstered storage box/trash container between front seats.
- Small removable table in driver's cabin.

\* subject to change without notice. (Not available in Canada).



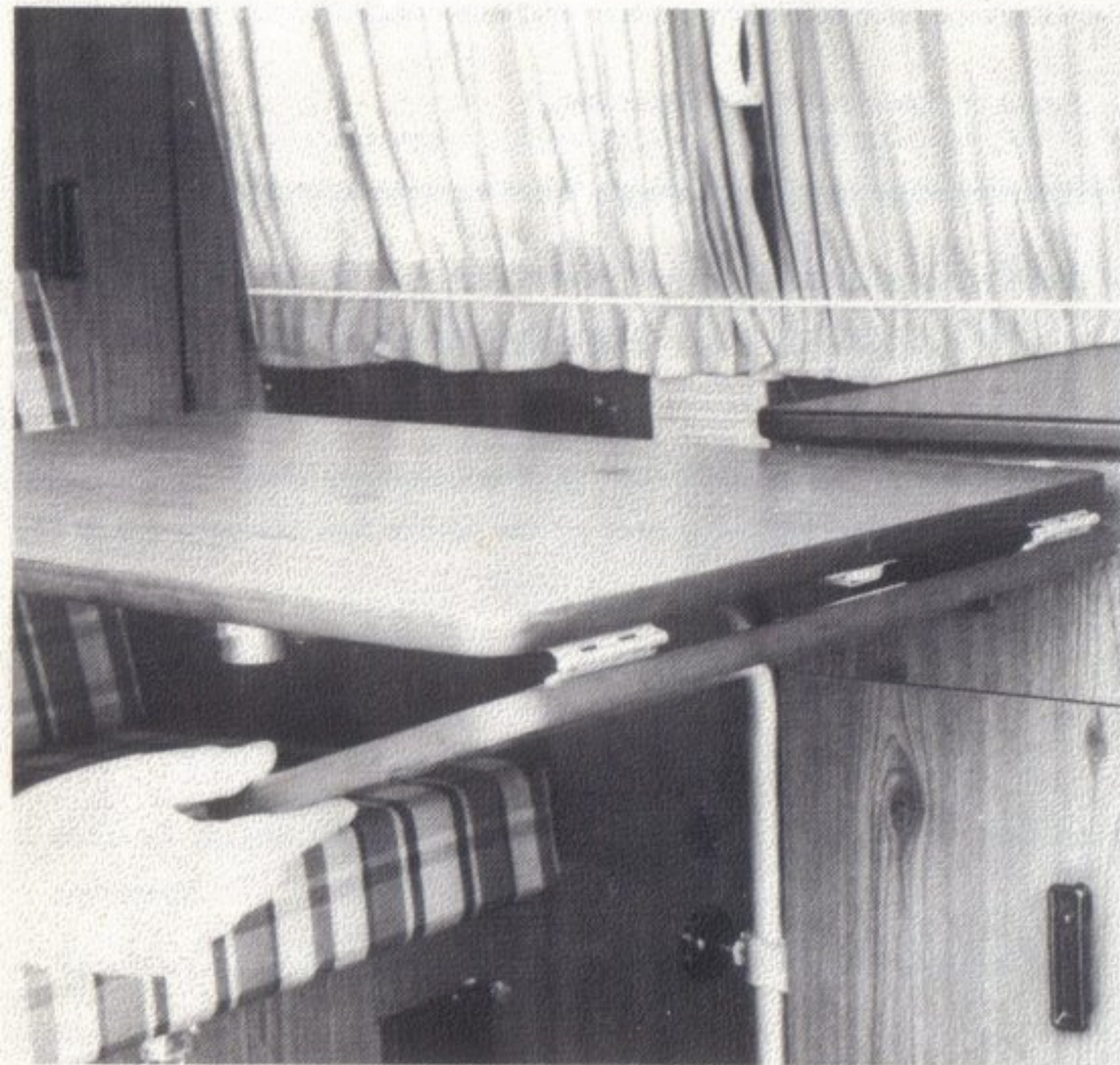

## 1. BASIC EQUIPMENT

### Dinette Table with Hinged Side Leaf

The rotating table pivots at the top and base of the table leg. To rotate the table top, first loosen the two hand stops.

The table can be extended by folding the hinged side leaf up. First pull the leaf out of its locking latch under the table top. Fold the leaf up and secure it in place by pushing the locking slide to the stop under the leaf.

**Be sure the table top does not press against the gas range knobs.**

(The gas range is only included in the Deluxe Campmobile equipment package. Gas range not available for Canada vehicles).

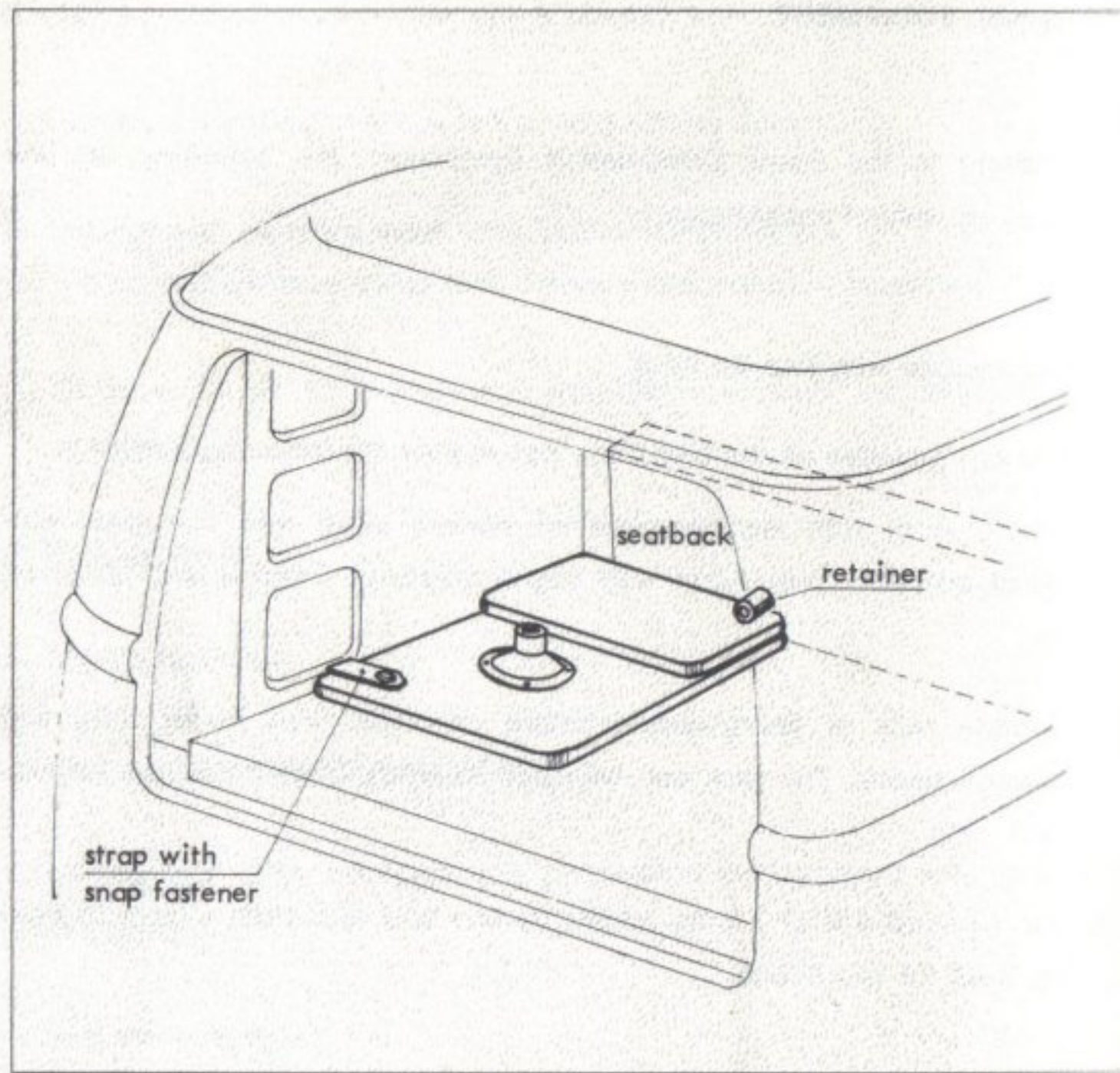

### Important

**The table top should be removed and stored on the rear deck mattress before driving.**

- Loosen hand stop at top of table leg and remove table top.
- Place table top, **with bottom side up**, on rear deck mattress.
- Slide side with folded leaf under retainer on back of seat bench.
- Secure table top in place by fastening strap at lower part of linen closet to table top.
- Loosen hand stop at table leg and swivel leg against sink cabinet. Then tighten hand stop again to keep table leg firmly in place.



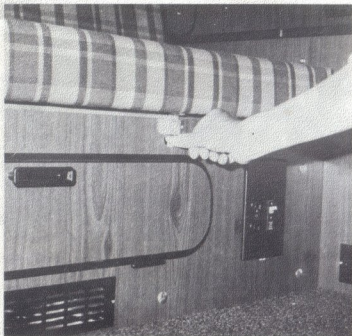

#### Rear Bench

The rear bench unfolds to become a full-size double bed at night. To set up the bed, remove the dinette table first. Push the safety belts between the bench and backrest. Depress the release under the seat cushion while lifting the seat cushion at the front. Continue raising the cushion until it touches a stop. This will disengage the backrest. Now pull the seat cushion forward while pushing the backrest down onto the support between the seat and rear mattress.

To set the bench up again, stand in front of the bench.

Slightly lift both seat cushion and backrest and push them toward the rear. Relocate the safety belts by pulling them between the seat cushion and backrest. Press the seat down to securely lock it in place.



#### Rear Deck Mattress

Do not place heavy objects with sharp edges on the rear deck mattress. Such objects may damage the upholstery or may get dislodged while you are driving and cause injury.

#### Note

Do not use the double bed to transport passengers. Do not allow children to kneel or sit on the rear deck while you are driving. For your safety, make sure seat bench and backrest are securely locked in place, that passengers sit in an upright position and wear seat belts.





### Storage Locker

The large storage compartment under the bench is accessible from the front through a door on the lower seat panel. Depress the push-button release in the door handle to open the door.

The storage compartment can also be reached from the top by lifting the seat cushion. First depress the release tongue under the seat cushion, then raise the seat at the front edge. When you lower the seat cushion be sure to press it down firmly to lock it in place.

### Identification Plate

The identification plate in the lower corner of the front panel contains the vehicle type and Campmobile equipment serial number. Please give this number when ordering spare parts for the **Campmobile equipment**.

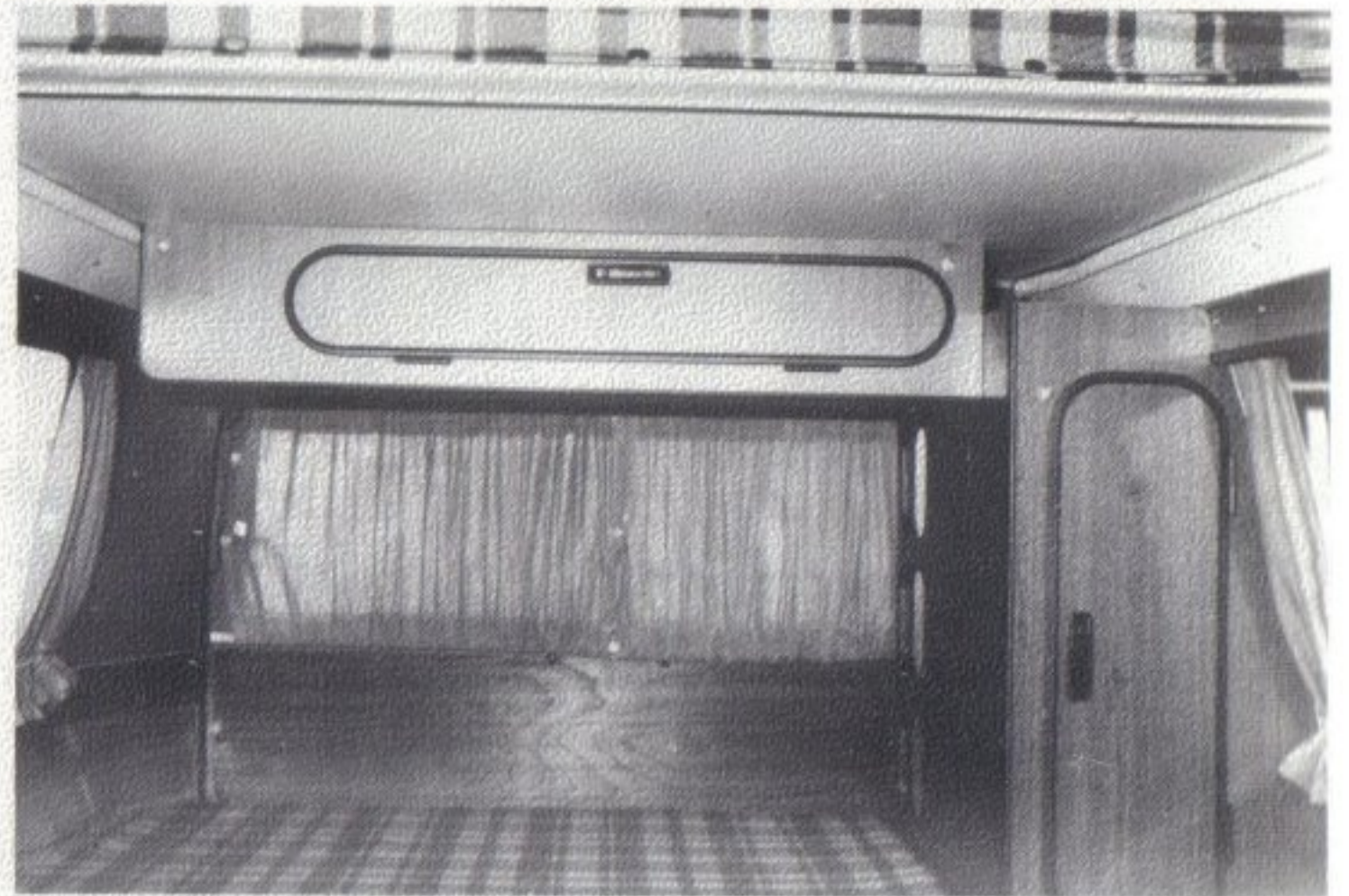

### Ceiling Cabinet

The ceiling cabinet is located in the rear of the vehicle above the rear mattress. To open the cabinet, first press the push-button release in the door handle.

Only light items, such as clothes or linens, should be stored in the ceiling area. **Maximum load should be no more than 19 kg (20 lbs.).**

### Clothes Closet

The clothes closet comes with a clothes hanging rod and a vanity mirror. Depress the push-button release in the door handle to open the clothes closet.

### Linen Closet

A roomy linen closet is in the rear wall next to the clothes closet. The three open compartments are best accessible through the rear lid of the vehicle.



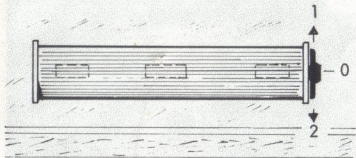

#### Ceiling Lamp

The 12-Volt ceiling lamp includes three 12 Watt bulbs and a three-position switch on the housing. In Position "0" the lights are off. Position "1" lights up one bulb. Position "2" lights up three bulbs.

#### Electrical Network (110-125 Volt A.C.)

To make use of the regular house current available at many campsites, your Campmobile is equipped with an electrical network that can be connected to the outside electrical power supply.

On the outside of the vehicle, below the rear left window, there is a three-prong hook-up receptacle. On the inside of the vehicle, in the kick panel under the rear bench, you will find two three-prong outlets and the circuit breaker with master switch. These outlets can only be used for electrical gadgets requiring 110-125 Volt A.C. current.

In case of a short circuit or overload, the circuit breaker will interrupt the power flow. Reset the circuit breaker (by flipping the switch to ON) only after the cause of the short circuit or overload has been eliminated.

A 15-Ampere A.C. cord is standard equipment with your Campmobile. It enables you to plug into campsite electrical outlets through the electrical receptacle.

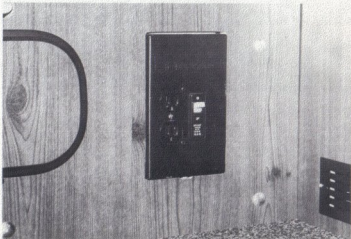
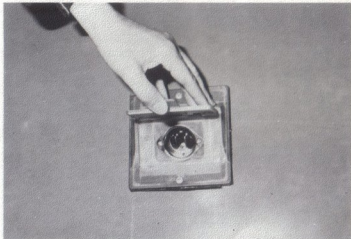



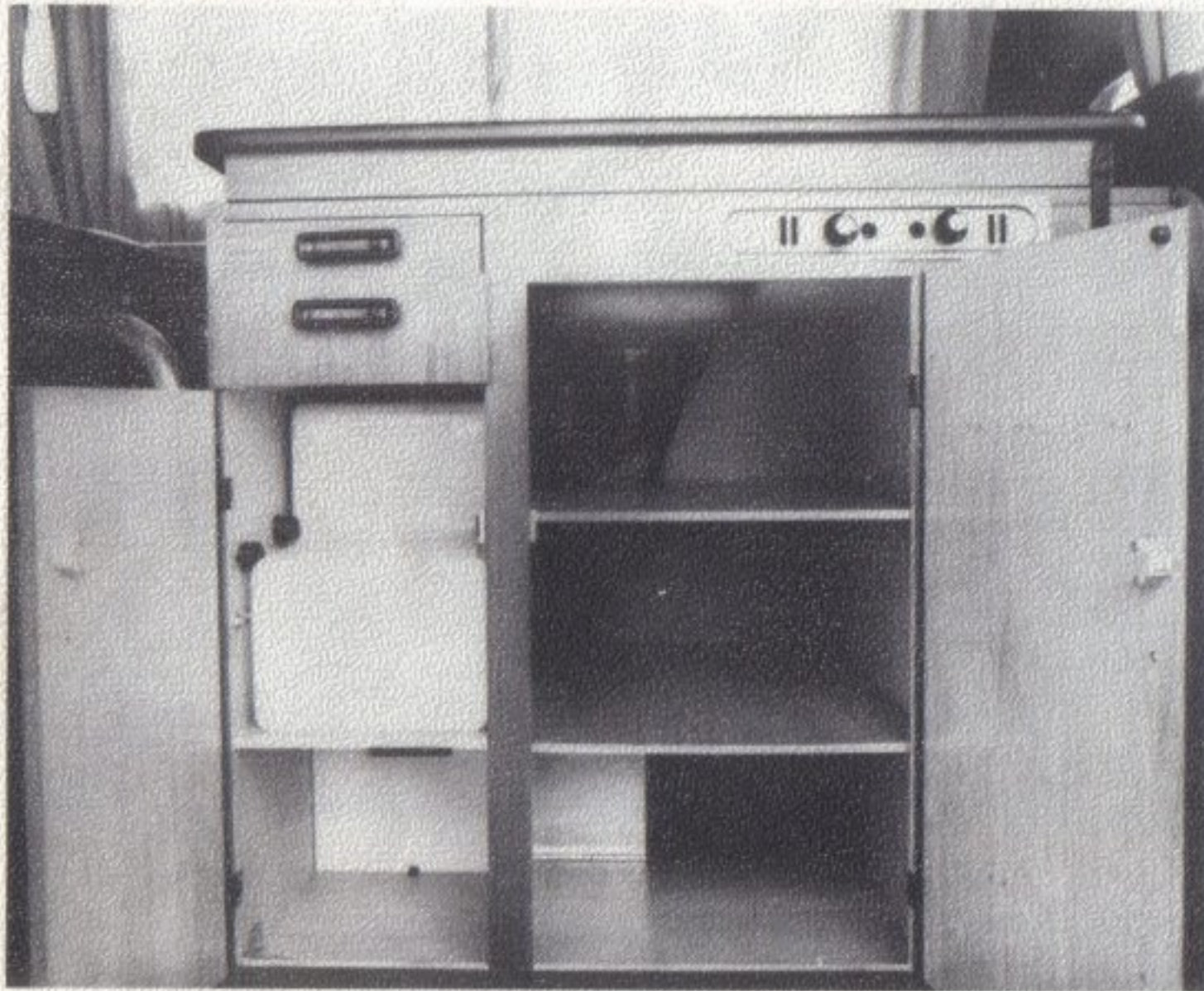

### Sink Cabinet

The sink cabinet combines the sink, electric water pump, water tank, two utensil drawers and ample storage on the shelves. The right section of the cabinet houses the spare wheel. See page 12.

### Utensil Drawers and Cabinet Doors

To open the drawers or cabinet doors, first depress the push buttons in the drawers or door handles. **Remember to keep the utensil drawers and cabinet doors firmly closed while driving.**

**The sink** is made of stainless steel and comes complete with a drainage and venting system. The vent pipe extends through the side of the vehicle. A raised plastic cap on the outside provides weather protection for the vent opening while allowing the sink drain to be ventilated. The drain from the sink extends through the bottom of the vehicle and has a screw-on cap. **Remember to unscrew the cap to open the drain before using the sink.**



Water from the sink drains onto the ground, **so be mindful of where you drain the sink water.**

**The 26 liters (7 gallons) water tank** is located in the left section of the sink cabinet underneath the utensil drawers. The filler cap is on the left side of the sink. The switch for the water pump is positioned on the left next to the faucet. Turn the knob once to the right to start the pump. Turn it once again to the right to stop the pump.

### Important

**Water pump must not be operated with an empty water tank.**

We recommend you **drain the tank** after every trip. The tap is below the tank in the lower compartment of the cabinet. After draining the tank, close the tap but leave the filler cap open to allow the tank to air out. Should standing water develop an odor, flush out the tank with a solution of baking soda and water. Be sure to follow the directions on the box. Rinse the tank well with clear water and allow it to dry.



**Caution: The Electric Water Pump must not be operated with an empty water tank.**

The 12-Volt pump is protected against overload by a 3 Amp fuse.

To replace fuses (see Illustration on next page):

- reach through cut out opening of ply-wood panel (1) at rear of storage compartment directly below water tank
- press up fuse holder (2) and twist to open
- replace fuse (3) and reseal holder securely

### Icebox

To open the 33 liters (1.1 cu. ft.) icebox, unsnap the retaining strap first. **Remember to keep the retaining strap fastened when the vehicle is in motion.**

In the upper part of the icebox, an **ice rack** is provided to hold block ice, ice cubes or freezer ice packages in place. The catch basin under the ice rack is designed to collect the melted ice and drain it to the outside through a separate tube.

We recommend you use unbreakable plastic bottles and food containers. Avoid glass containers on camping trips. Any items placed in the icebox should be tightly sealed to prevent spillage.

### Storage Chest

To open the chest, unsnap the retaining strap first. Then lift the cover. Keep the strap fastened when the vehicle is in motion.

### Location of Electric Water Pump Fuse

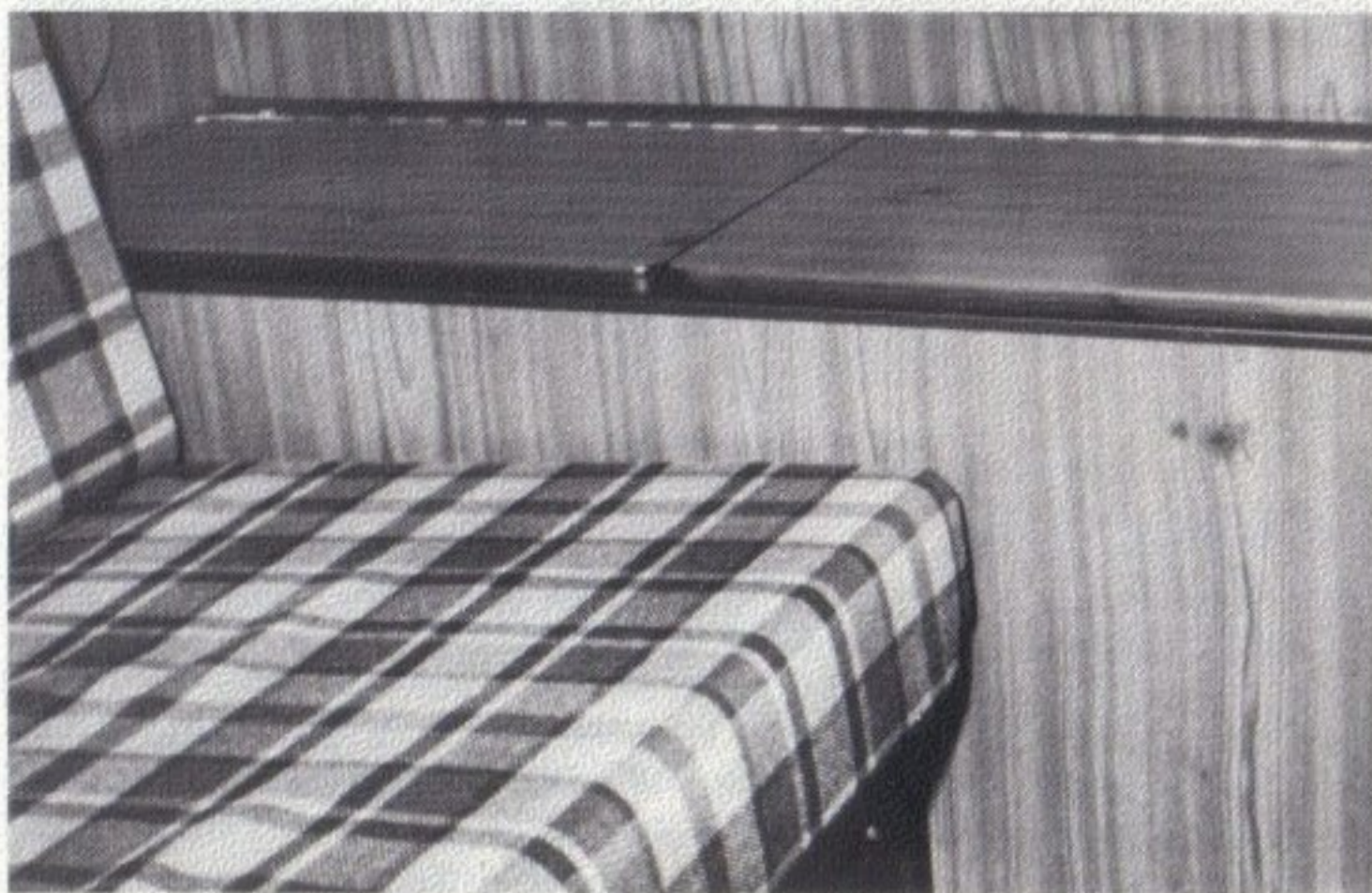
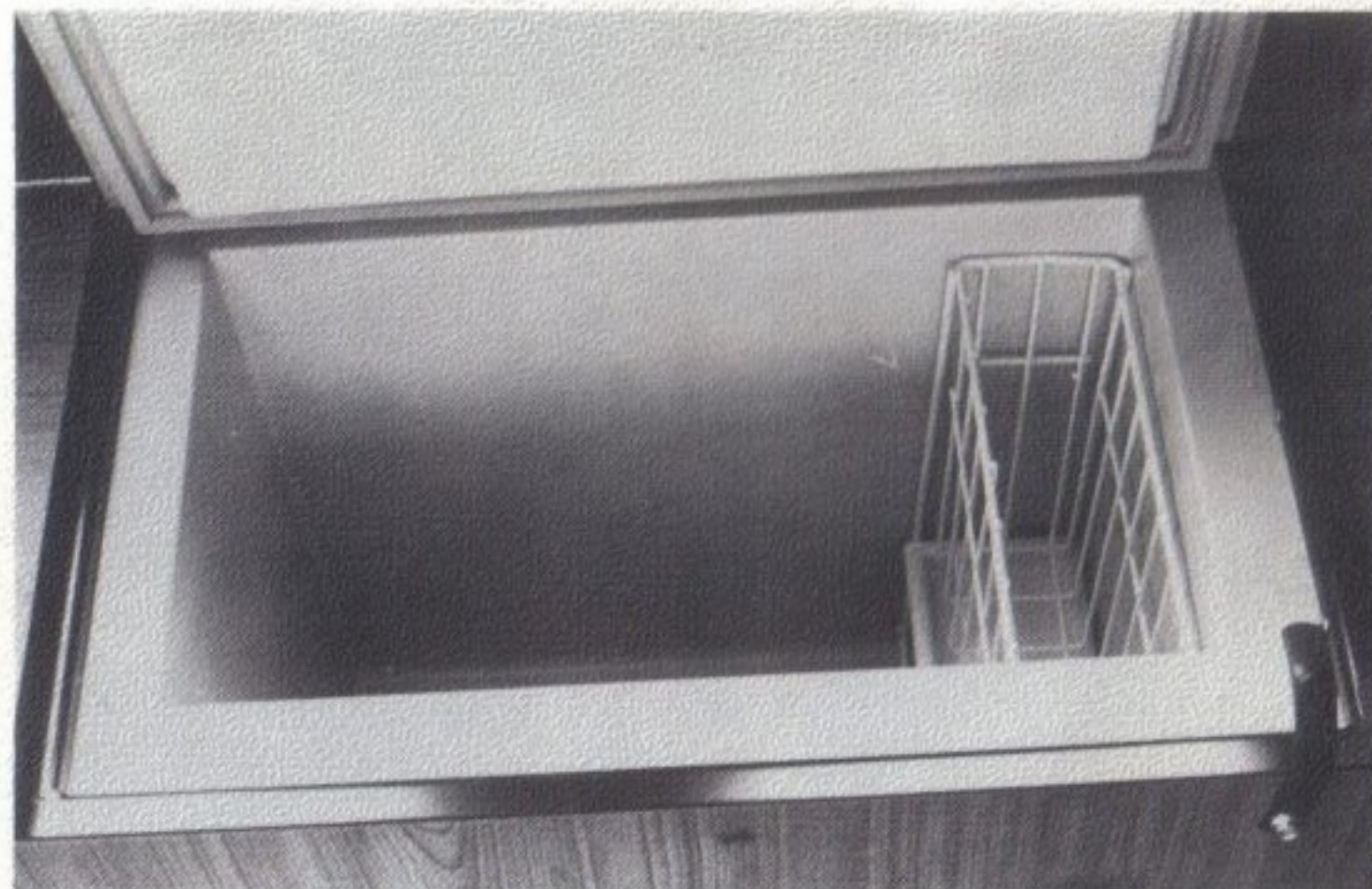
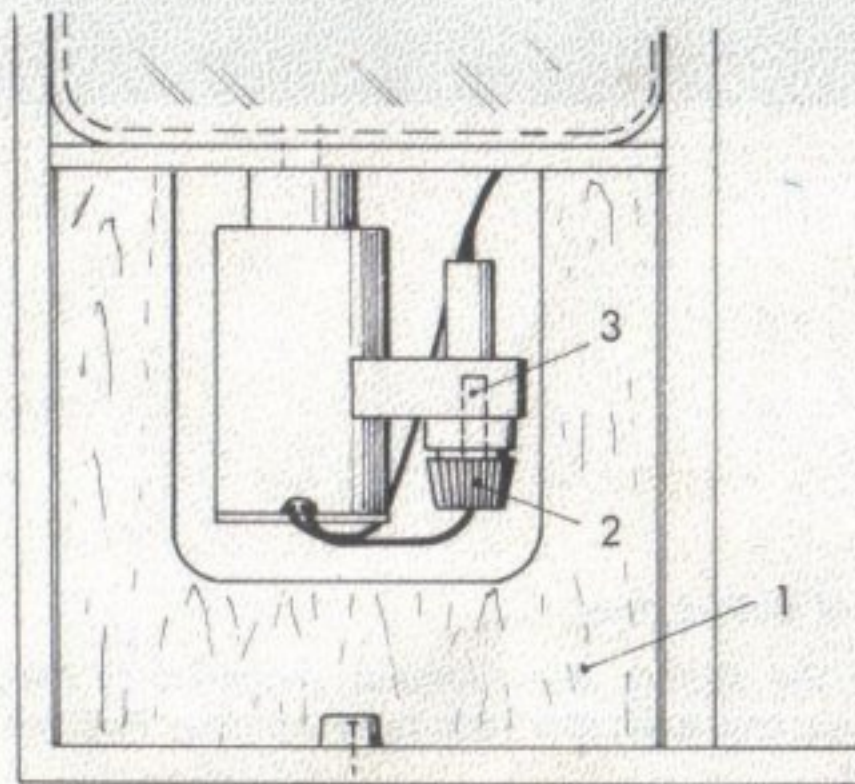





### **Spare Wheel**

The spare wheel is stored in the right section of the sink cabinet. To open the cover, unscrew the **hand screw** at the top of the cover, and remove cover. Pull the spare wheel out from the bottom toward you.

When reinstalling the cover, make sure the **tongue at the bottom of the cover inserts in the slot at the lower end of the spare wheel well**. Replace the hand screw at the top of the cover and tighten.

**To change a wheel, follow the instructions in your Owner's Manual.**

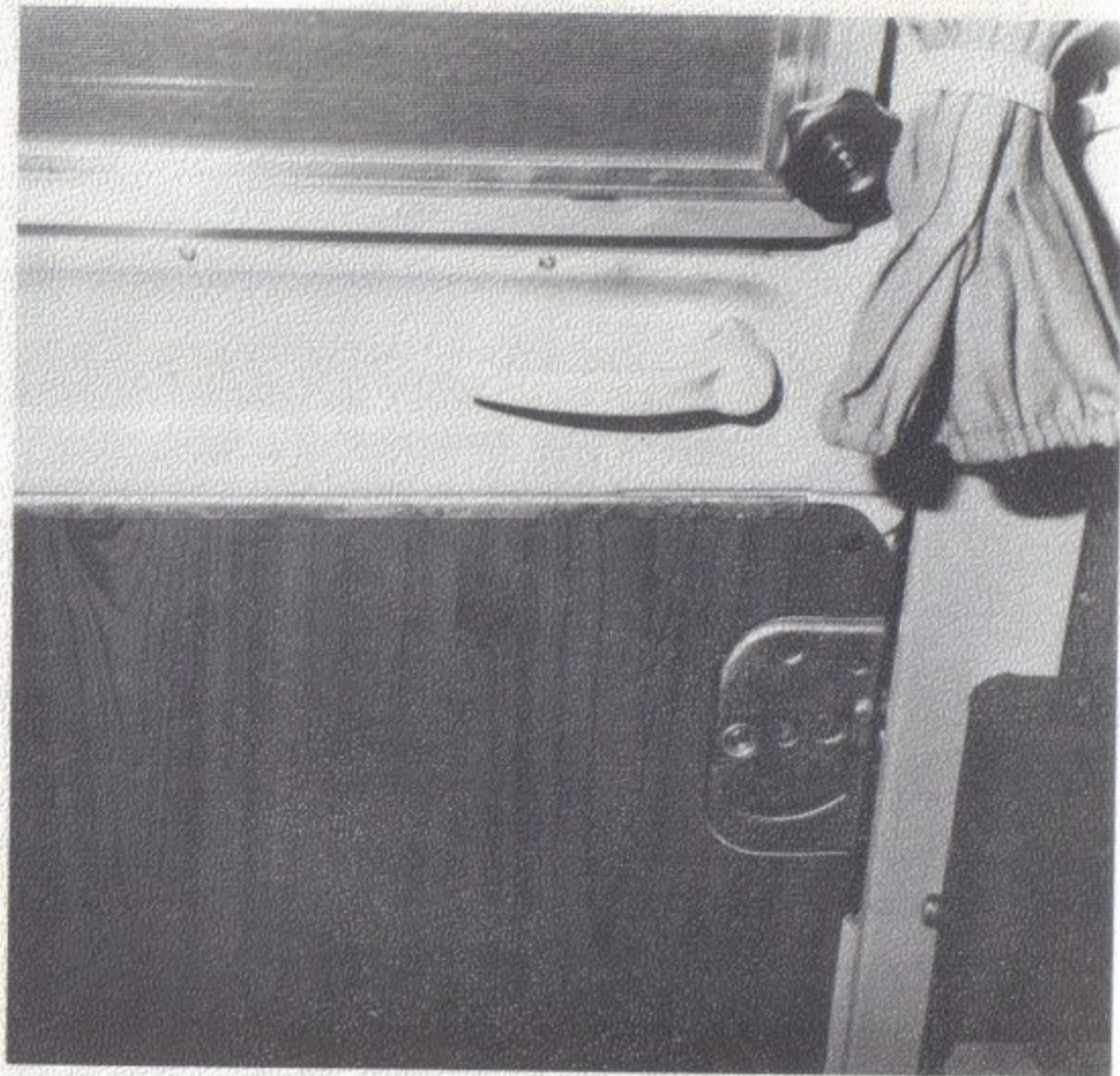

### **Handle at rear of sliding door**

You can close the sliding door without slamming it shut. Slide the door forward until you can grab the rear door handle. Pull the handle to close the sliding door.



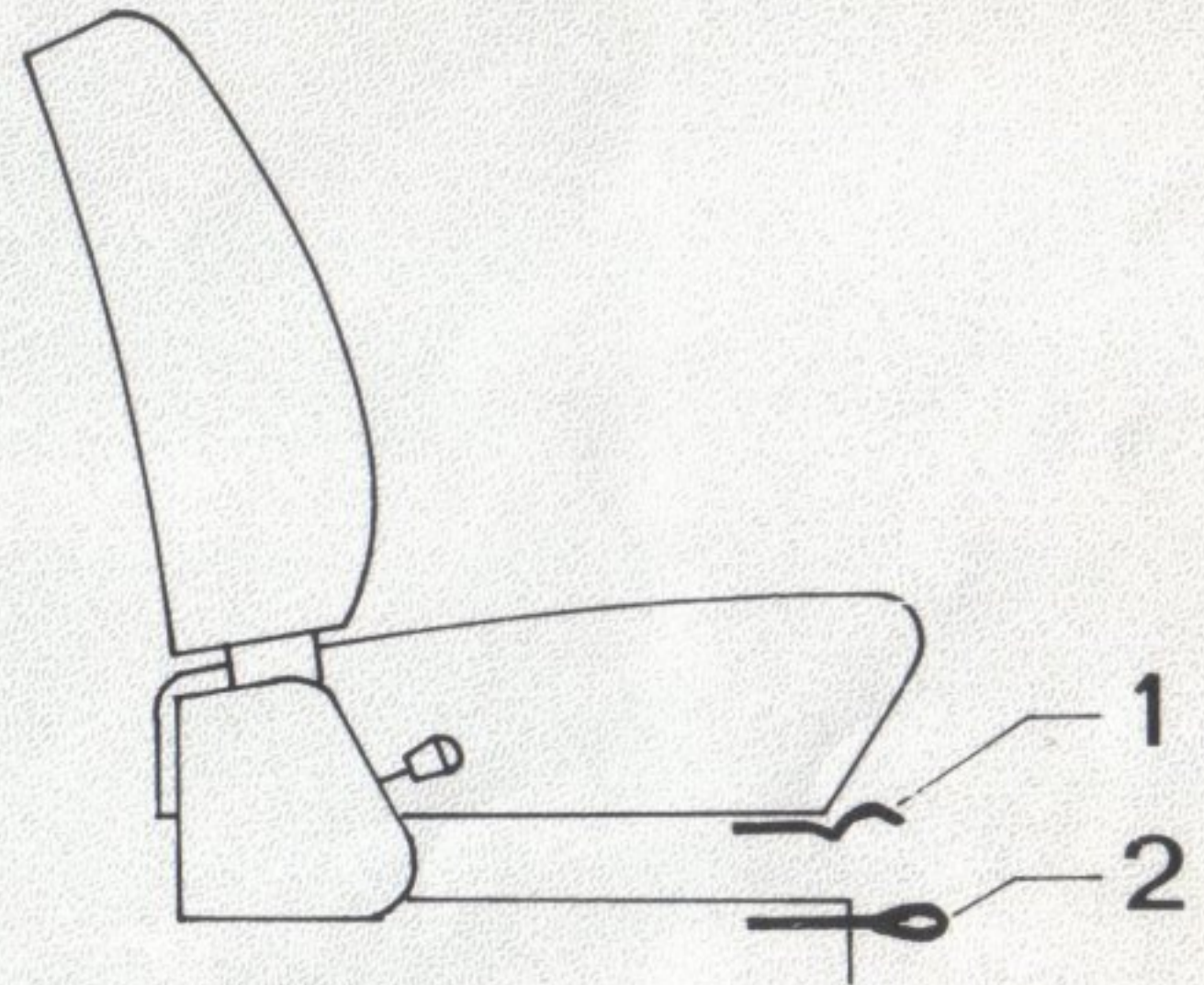

### Swivel Seat

To turn swivel seat towards „living room“ do the following:

- Remove storage box between front seats, where applicable. Press down flexible anchor housing for the safety belt.
- Push down or lift up handle (1) under centre of seat and move seat slightly forward.
- Depress release (2) in centre under seat and swivel seat 180° to the left until seat locks in the „living room“ position.

Whilst driving, swivel seat has to be in „travelling“ (forward) position.

For your safety wear safety belts while vehicle is in motion.



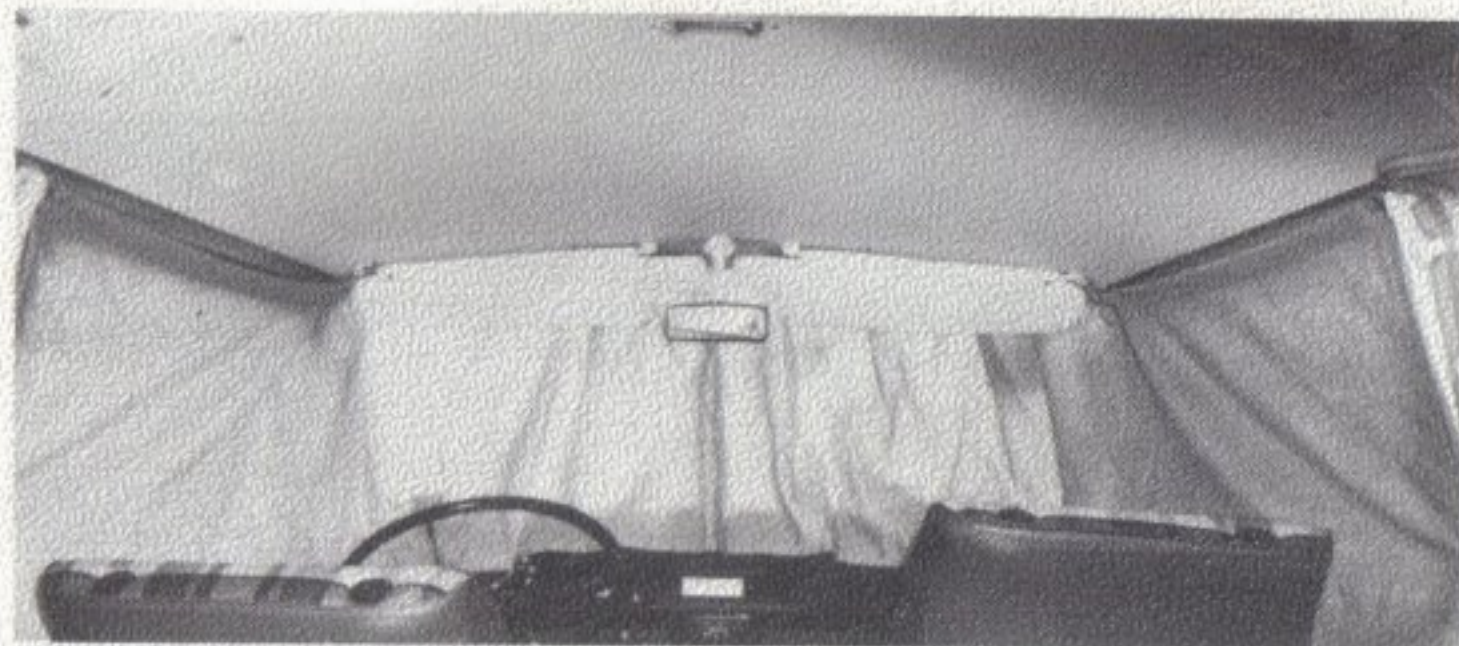
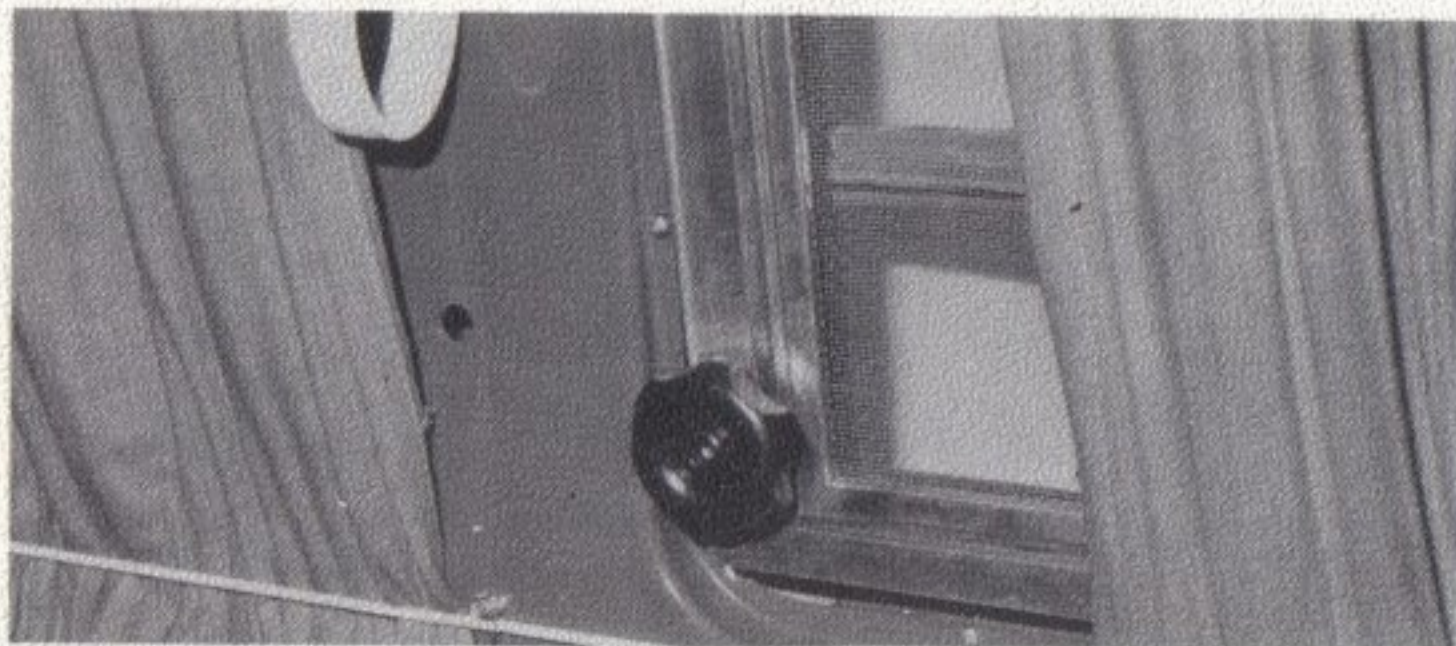

### Louvered Windows

The Campmobile is equipped with two louvered windows, one on the sliding door and the other in the opposite side wall. To open the louvers, turn the large black knob clockwise. **To avoid damage please do not tighten the black knob more than necessary.**

Each louvered window has a removable screen. To remove the screen slightly raise it and pull the bottom out of the window frame. To install the screen, reverse the procedure.

**We recommend you keep the louvered windows closed when the vehicle is in motion. These windows were designed to be used at the campsite only. Prolonged driving with the louvers open could weaken the pane hinges.**



### Interior Curtains

The interior curtains cover all the windows in the Campmobile, even the windshield. With them, you can have as much privacy as you want! They can be snapped in place by the use of the snap fasteners provided on the window sills and wall panels.

**Safe driving requires that you have an unobstructed view of the road at all times while driving. Remember to reposition the curtains so that you have unobstructed vision all around.**

Dry cleaning is the best method for cleaning the interior curtains. They can also be hand-washed with mild soap in lukewarm water.

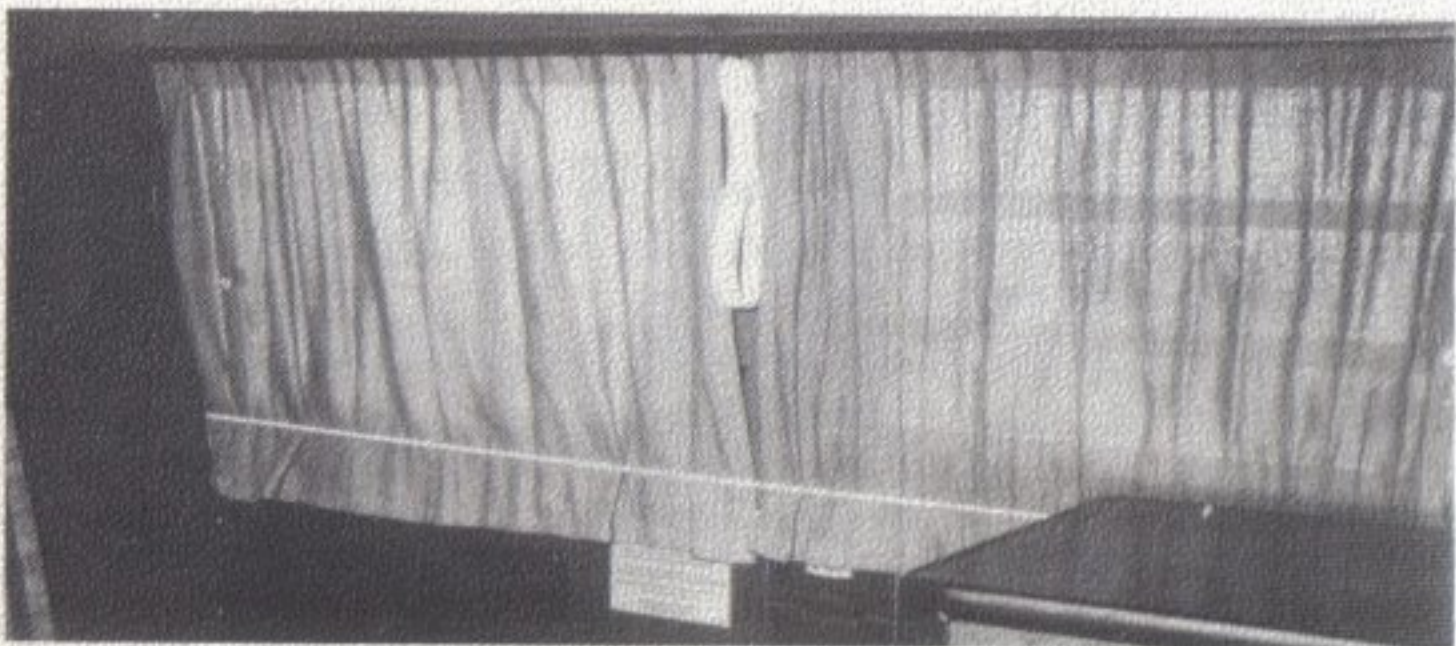



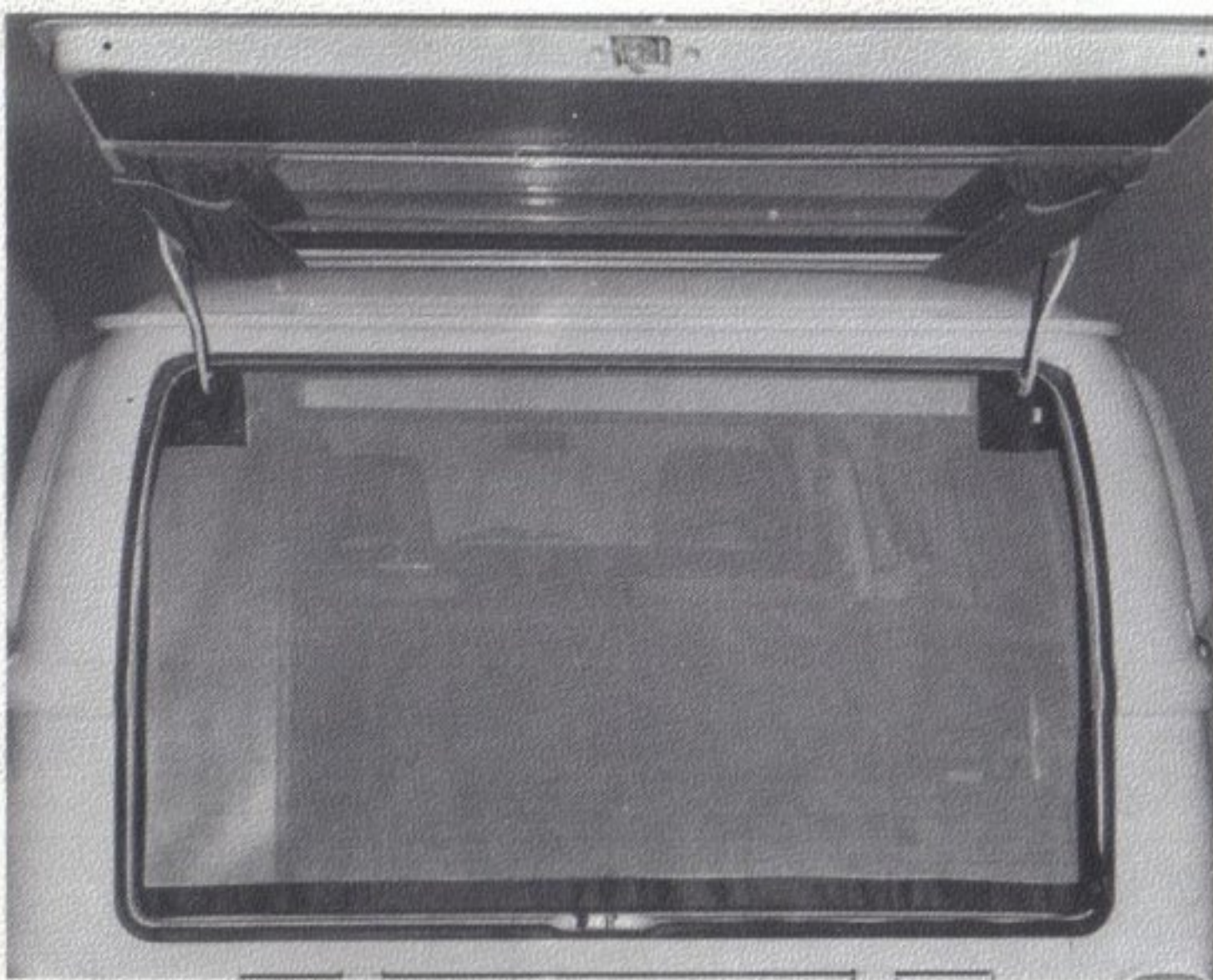

### Rear Lid Screen

The rear lid screen and the louvered windows form an excellent flow-through ventilation system for comfortable sleeping at night. It allows you to keep the rear lid open, while keeping annoying insects out of the Campmobile.

The rear lid screen can best be installed with the rear lid open. To install the net, simply press the snap fasteners in the proper locations. The lid can be closed with the screen installed.

**Do not drive with the rear lid open to preclude the possibility of exhaust fumes entering the vehicle.**

### Child's Hammock

The hammock provides comfortable sleeping for a small child. **The child using the hammock should weigh no more than 40 kg (90 lbs.).** Remove head

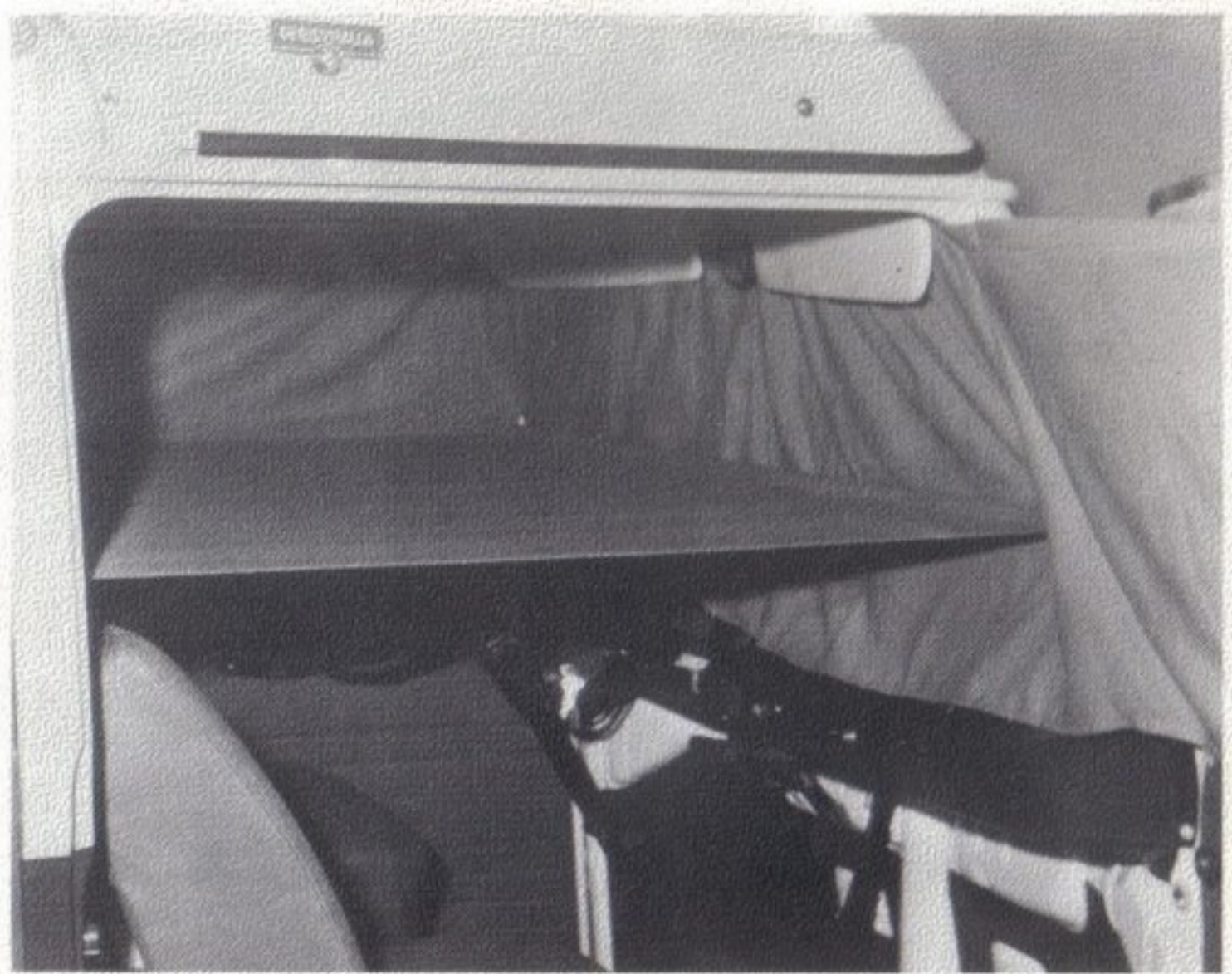

restraints from front seats (where applicable) before installing the hammock. The hammock poles are retractable so that the rolled up bed can be stored in the storage locker under the rear seat bench.

Unroll the hammock, extend the poles and attach to the four mounting hooks over the driver's seat and the front passenger's seat (two on front side pillars and two on door posts).

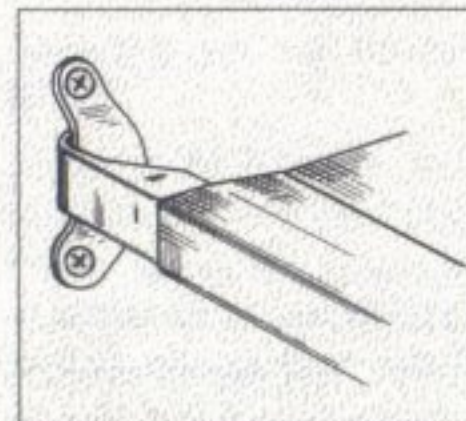

After use, retract poles, roll up hammock and store in rear seat bench. **Do not leave the hammock lying about in the vehicle as it may become a dangerous projectile during a sudden stop and cause injury.**



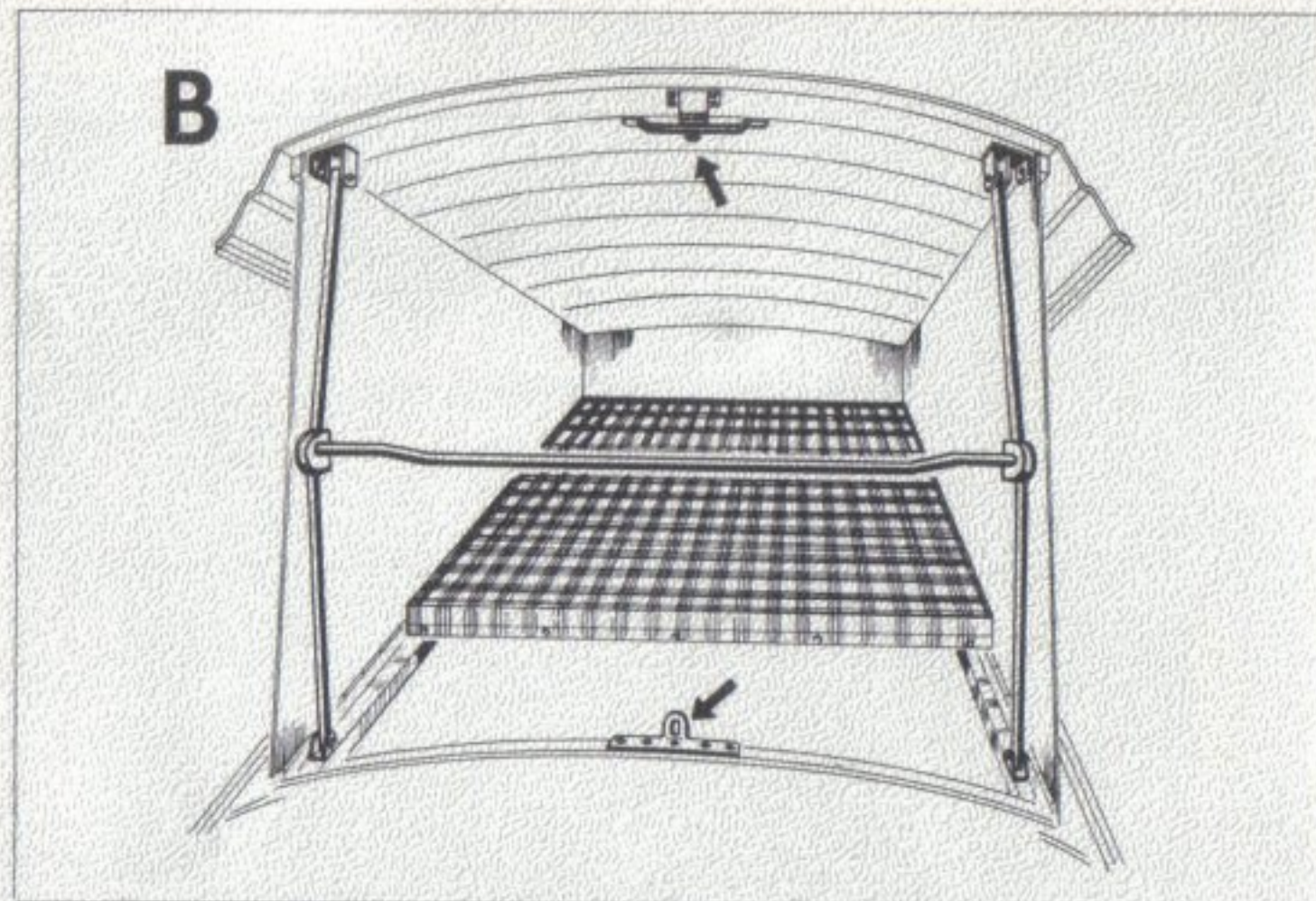
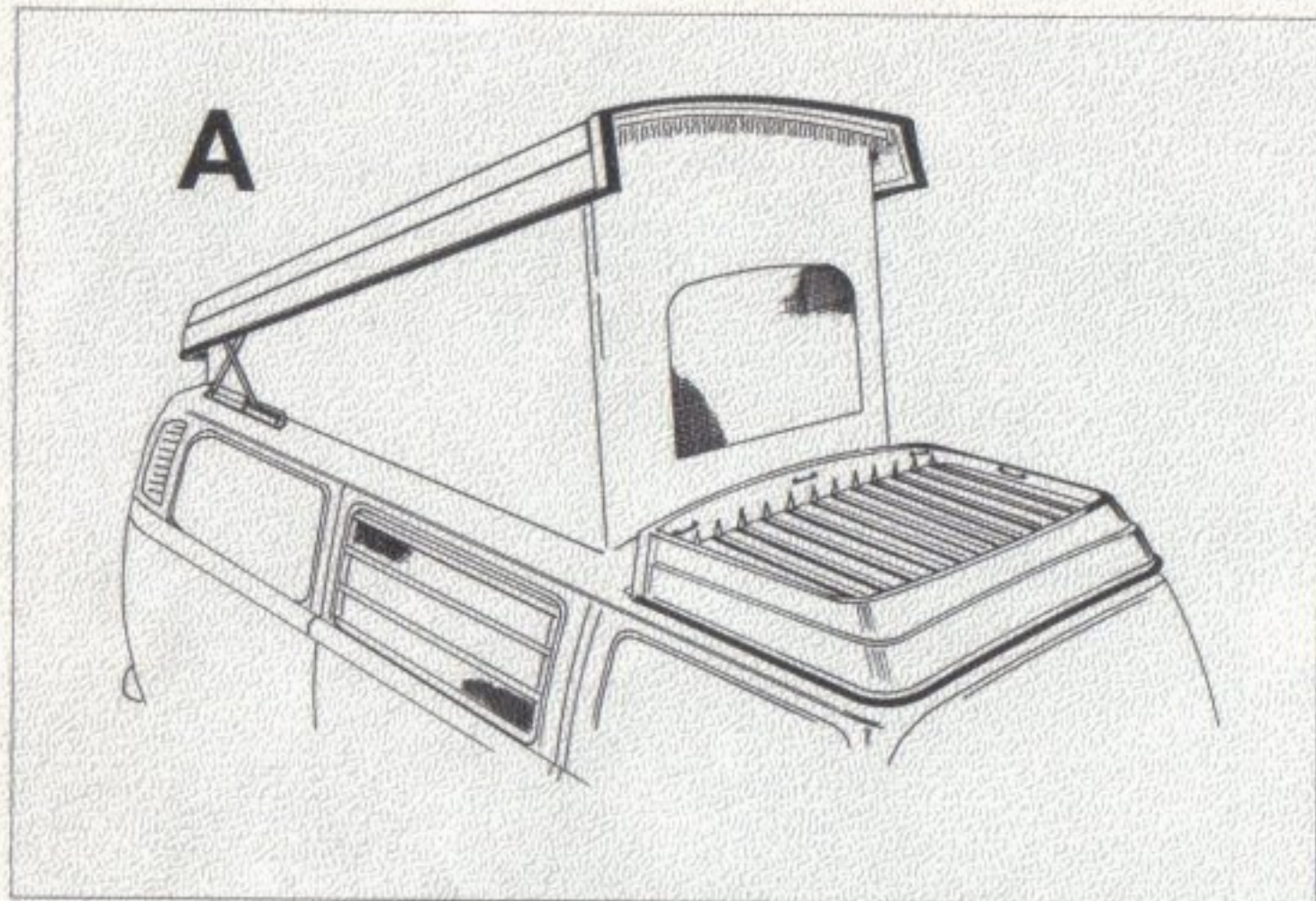

## OPTIONAL EQUIPMENT

### 2. Campmobile with Pop-Up Roof

This option includes all the basic equipment explained on the previous pages plus the following items:

#### Pop-Up Roof

The entire roof of a Campmobile equipped with this option has a fiberglass-reinforced polyester top. The larger rear portion of the roof is the actual Pop-Up Roof (Illustration A).

To **raise** the Pop-Up Roof, release the metal latch (arrows in Illustration B). When the latch is disengaged, simply push the crossbar up until the strut supports at the front of the top are locked into position.

To **close** the top, pull the crossbar back. As you lower the top, gather in the canvas sides of the top. Have someone outside the vehicle help make sure the fabric does not stick out from the sides of the roof. Pull the top down until the metal latch engages.

**To prevent damage to the top and sides of the Pop-Up Roof, the Campmobile should not be driven with the top in the elevated position.**



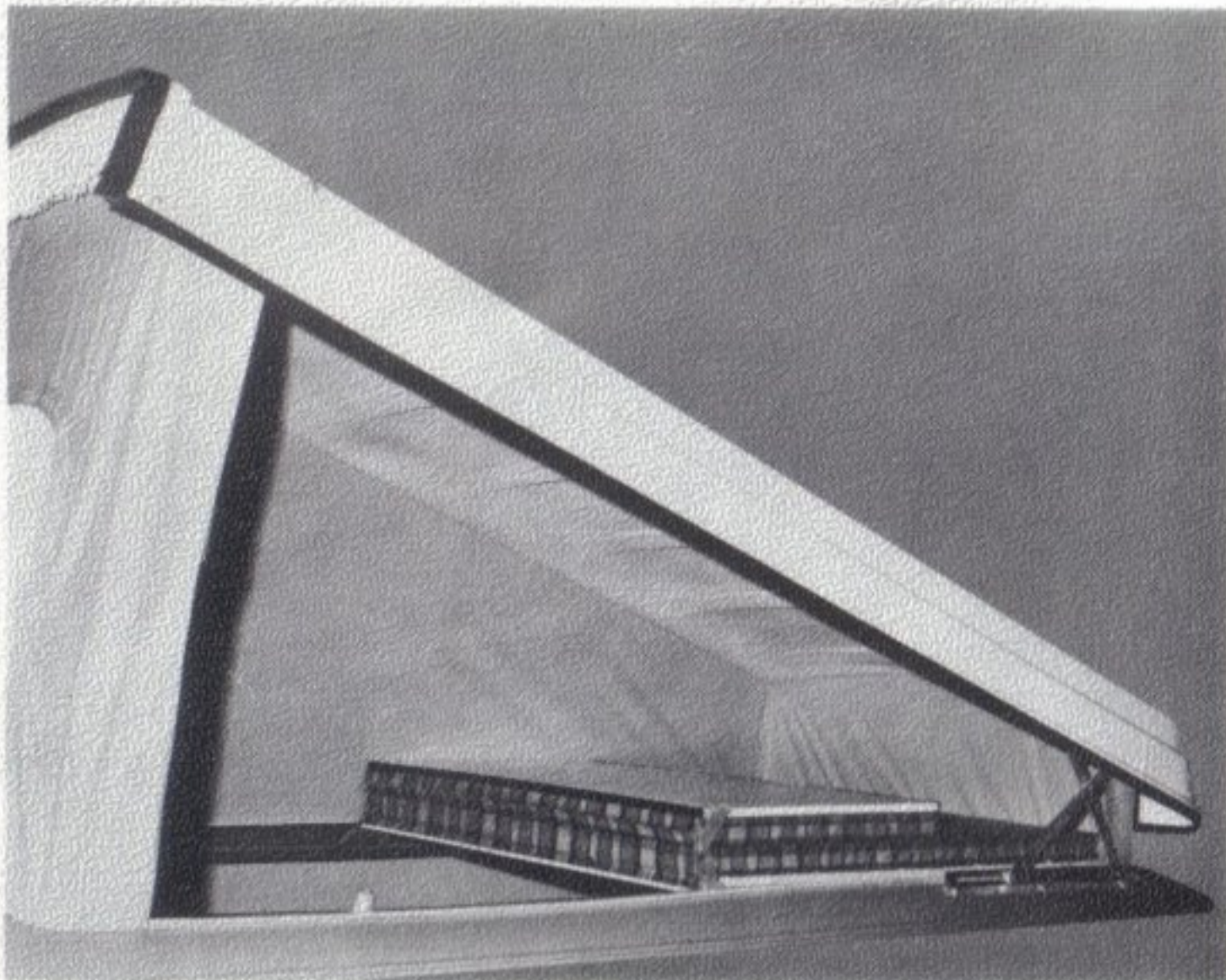

### Luggage Rack

The front section of the roof contains the luggage rack (Illustration A). It is equipped with buffer rods and tiedown hooks to facilitate loading and securing baggage. The luggage rack is accessible through the front flap of the Pop-Up Roof. Any baggage carried on the roof luggage rack should be securely tied down. Commercially available spider straps will keep cargo from moving around.

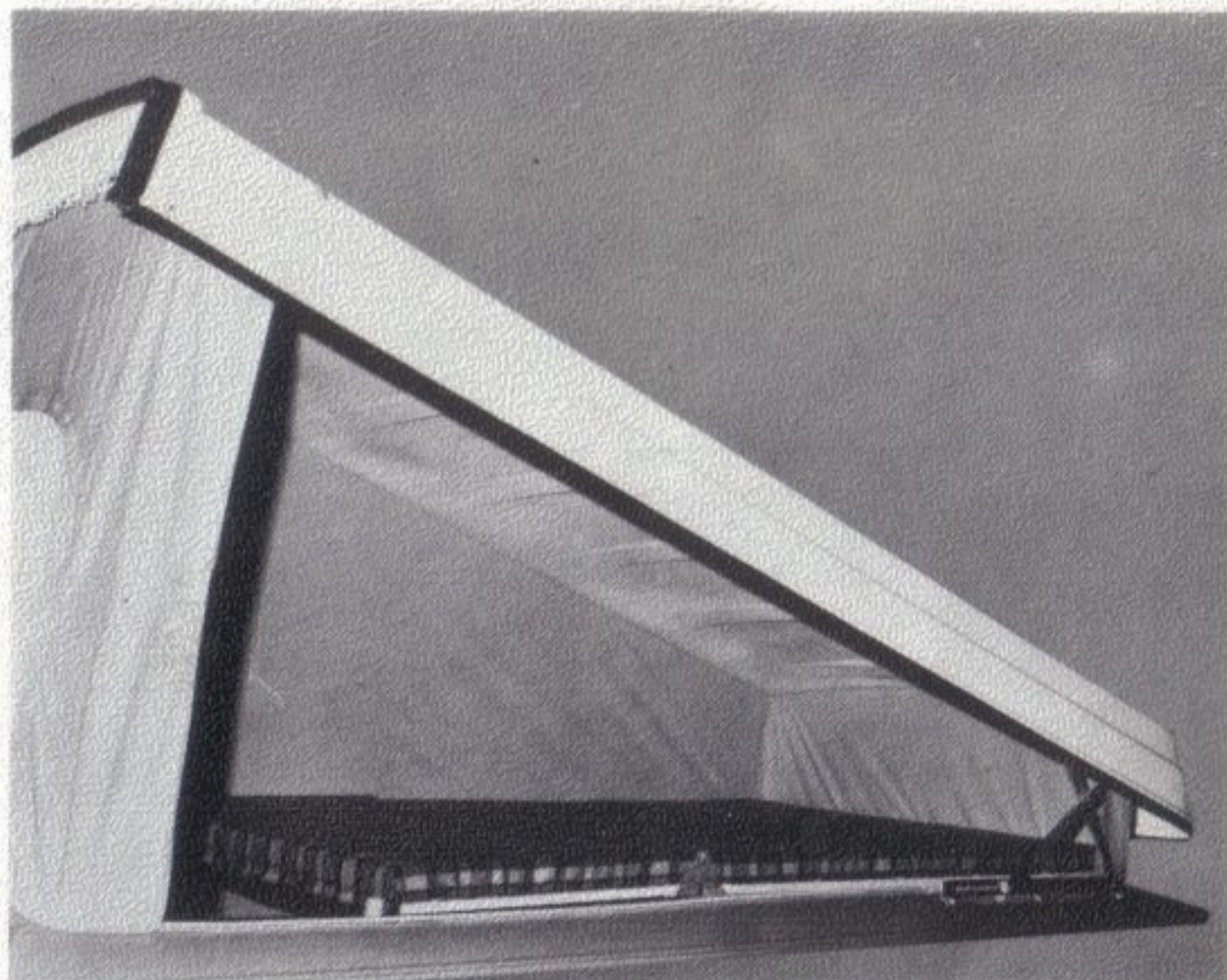

### Double Bed in Roof

A 1.8 x 1.2 m (6' x 3' 10") double bed is built into the Pop-Up Roof. The bed is folded away when the roof is down and can be easily opened at night with the roof up.

### NOTE

In order to prevent mildew-forming on the flocking and the canvas of the pop-up top, the roof should not be closed in a wet condition.

When using the pop-up top, the front flap in the canvas is to be kept open in order to ascertain fresh air-flow.

The air circulation must not be hindered by storing bedding etc. in the back part of the folded-down double bed.



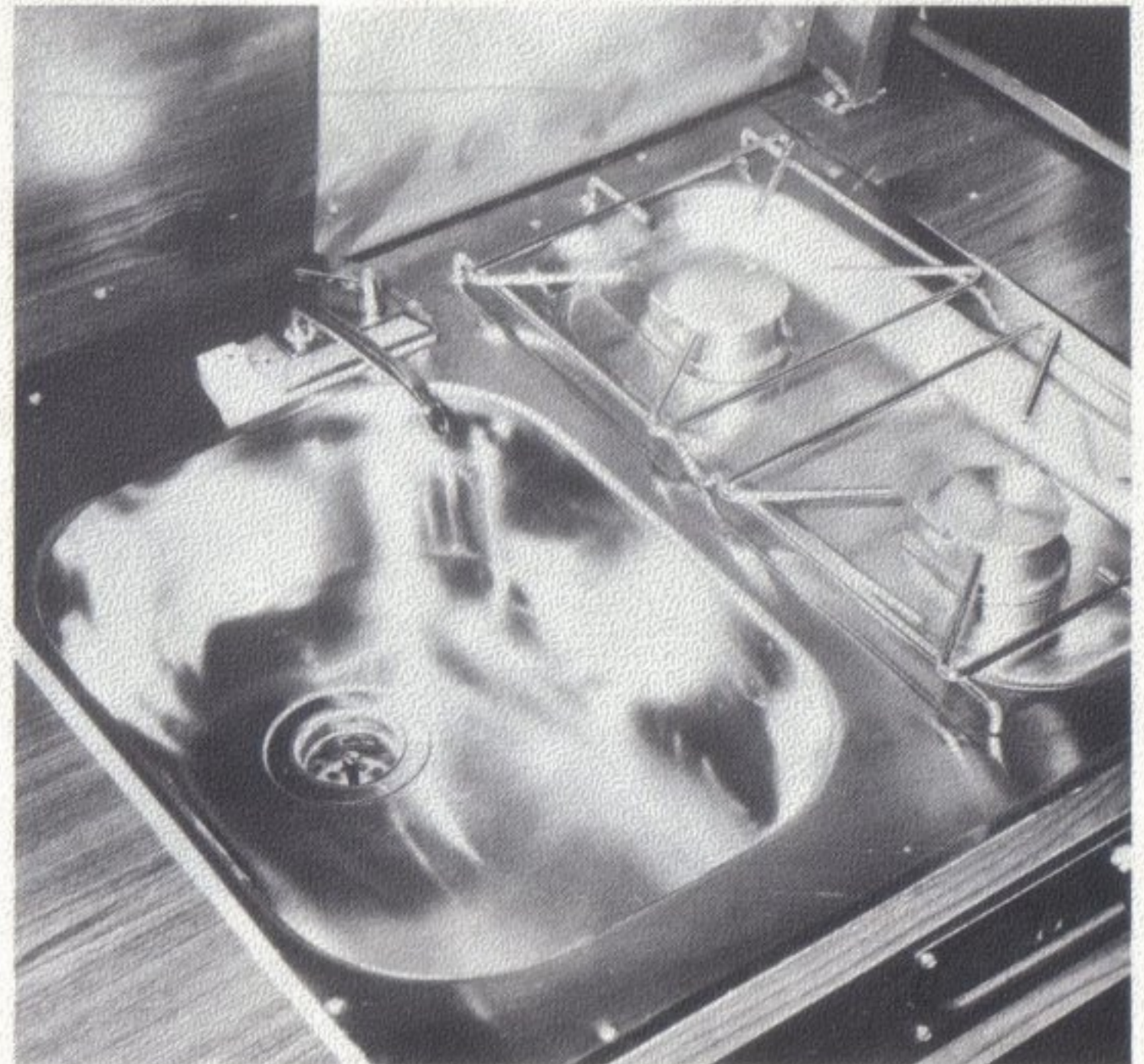
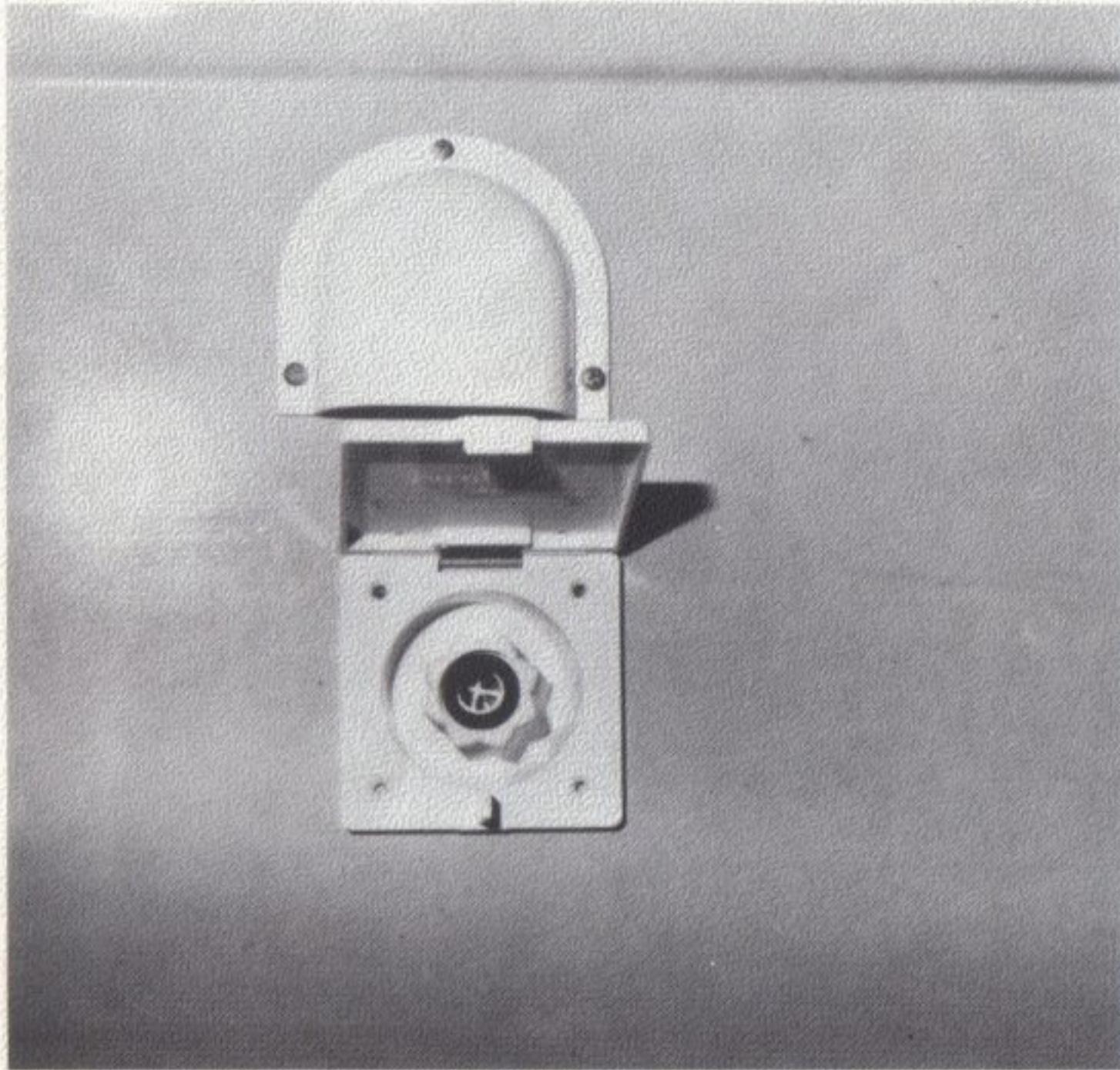

## OPTIONAL EQUIPMENT

### 3. Deluxe Campmobile with Pop-Up Roof

This is the most comprehensive option and includes all of the previously mentioned equipment plus the following items:

### City Water Connection

The sink cabinet is described on page 10.

To provide you with the convenience of ample water supply at the campsite, a hose fitting for city water connection is installed on the side of the vehicle.

To switch to city water, turn the lever on the right next to the spout a quarter turn to the left. To turn city water off, move the lever to the right.

### Caution

**Do not operate the switch for the water tank pump while the vehicle is connected to city water.**



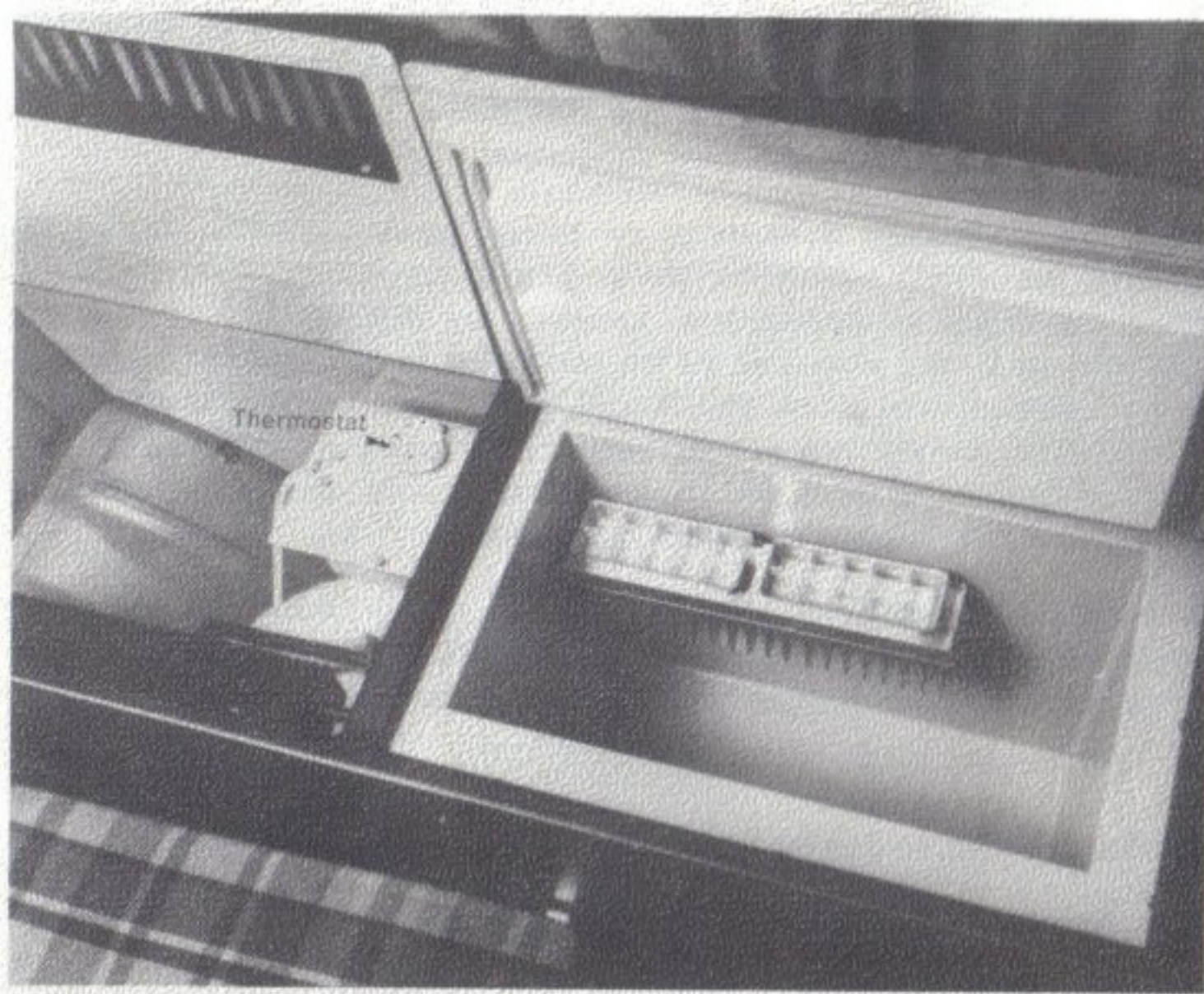

### Refrigerator Cabinet

An electric refrigerator is installed when you order the Deluxe Campmobile with Pop-Up Roof option. Storage compartments, folding tops and retaining straps are the same as those in the icebox-and-chest cabinet. Turn to page 11 to familiarize yourself with the different units.

The refrigerator in your Campmobile can be operated by battery power. A second battery has been provided for this purpose in the engine compartment. Or you can also make use of the regular 110-Volt power supply provided at many campsites.

### Hints

Before operating the refrigerator, be sure the vents in the front panel and the chest cover are clear to assure proper ventilation.

**When the refrigerator is in use, park the vehicle on level ground, as otherwise the refrigerator may not work properly.**

When the outside temperature is 32° C/90° F, cooling may not be sufficient to adequately preserve food in the refrigerator.

Food and other items in the refrigerator should not be jammed together. Leave enough space between the stored items for proper air circulation.

### Cleaning the refrigerator

Clean with lukewarm water and mild soap solution. After extended usage, it may be necessary to also defrost the refrigerator.

**The cover gasket should not come into contact with oil or grease.** Apply talcum powder to the gasket from time to time.



### How to operate the refrigerator

Before starting out on a camping trip, operate the refrigerator with regular 110-Volt A.C. current first. This will quickly cool down the refrigerator for food storage. For driving, switch to battery power to maintain the existing temperature in the refrigerator. At campsites where regular 110-Volt A.C. current is available, make use of the external power supply to preserve battery power.

### When using 110-Volt A.C. external power

Be sure the external power supply agrees with the sticker specifications on the outside receptacle of the vehicle before hooking up..

Select the appropriate power supply setting on the control panel above the refrigerator: **CITY POWER ON**. Also flip the switch to **REFRIGERATOR ON**. A converter transforms the 110-Volt A.C. from the external power source to 12-Volt D.C. with which the refrigerator is operated.

Set the cooling level with the knob inside the storage chest next to the refrigerator. The temperature is thermostatically controlled when the refrigerator is operated on city power.

Circuit breaker switch on kick panel of rear seat should be set to "ON" position (see also page 9: Electrical Network).

Circuit breaker does not function on battery power; battery circuit is independently fused (16 amp fuse in block fuse holder is in engine compartment beside battery on driver's side).

### When using 12-Volt D.C. battery power

Select the appropriate power supply setting on the control panel above the refrigerator: **BATTERY ON**. Also, make sure the refrigerator is turned on. A lamp will glow when the refrigerator is in operation.

Your Campmobile has two batteries. The second battery operates the refrigerator when the vehicle is not connected to an external power source or when the engine is running.

### Caution

The purpose of the second battery is to maintain the existing cooling temperature in the refrigerator for a short period of time.

\* The temperature in the refrigerator is not thermostatically controlled. Maximum use with a fully charged battery is 4 hours. However, avoid prolonged battery usage to operate the refrigerator **when the engine is not running** as this will lead to starting difficulties.

When the refrigerator is operated on battery power, **with the engine not running**, the starter battery for the engine is automatically disconnected. When the engine is started, both batteries are automatically reconnected and charged by the alternator. At the same time, a balancing of the charge in the batteries takes place. This means, if the second battery is discharged or low when you start the engine, some of the power in the starter battery is transferred to bring up the charge in the second battery **And this may make starting the engine difficult or impossible.**

To keep the batteries well charged, drive the vehicle from time to time or operate the engine in a well ventilated area, **with the refrigerator turned off.** Or have the batteries charged from an outside power supply.

### Control panel for refrigerator operation

The control panel is on the sidewall above the refrigerator.

Switch to **CITY POWER ON** when you want to connect the vehicle to an outside electrical network.

Flip the switch to **BATTERY ON** when you want to operate the refrigerator on battery power.

Turn the refrigerator on or off with the **REFRIGERATOR ON-OFF** switch. A control lamp will light up when the refrigerator is in operation.



## Control Panel – above refrigerator

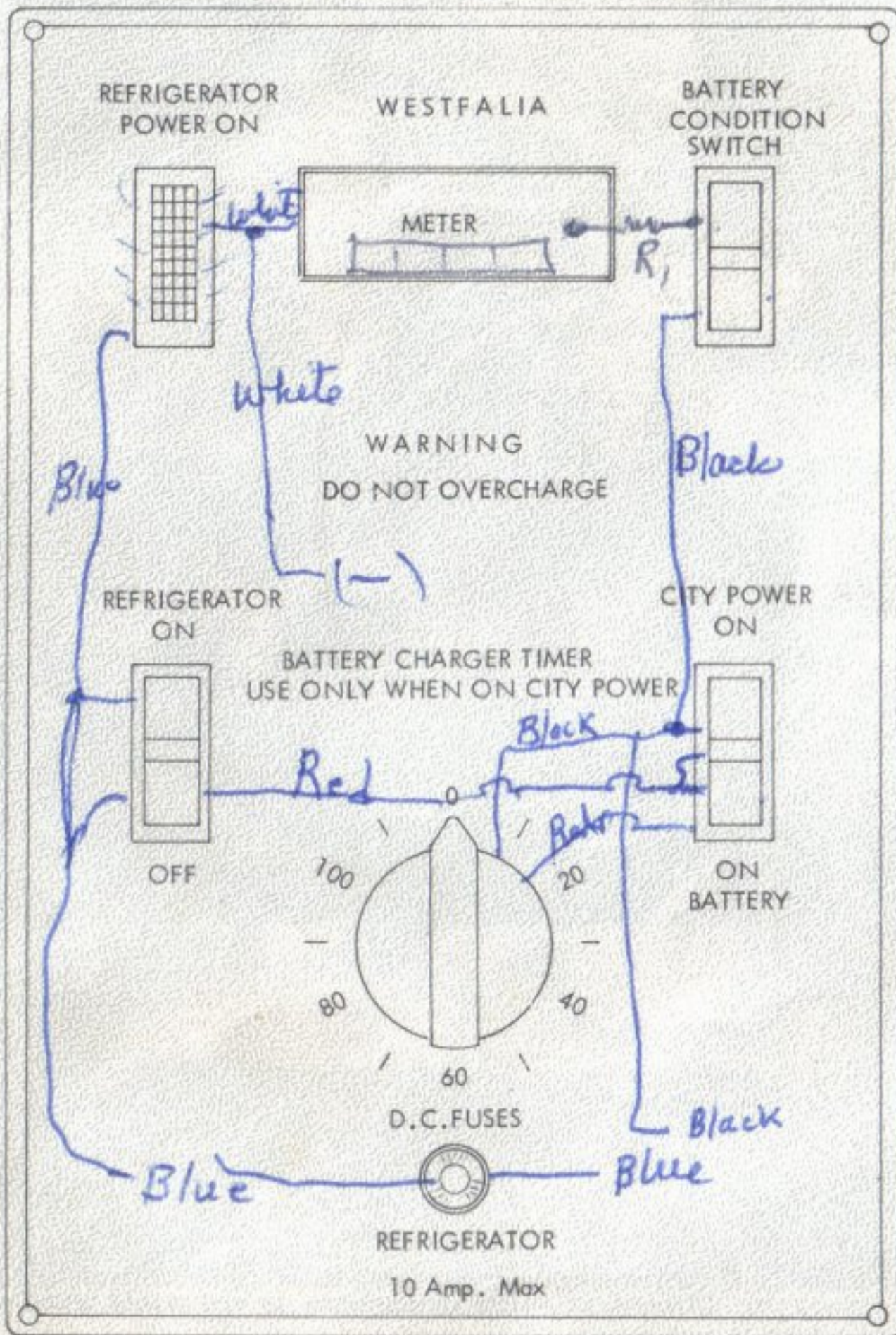

## Charging the Auxiliary Battery

With the converter in your Deluxe Campmobile you can charge the auxiliary battery. The converter transforms regular 110-Volt A. C. from an outside electrical network to 12-Volt D.C. for the batteries.

**Check battery condition by depressing battery condition switch. If color code indicates a need for recharging, proceed as follows:**

**Note:** You may keep the refrigerator running while the batteries are being charged.

1. Keep engine lid open to provide adequate ventilation.
2. Remove cap from each battery cell.
3. Connect vehicle to external 110-Volt electrical network with the 15-Ampere cord that comes with every new Campmobile. A three prong hook-up receptacle is on the outside of the vehicle below the rear left window (see also page 9).
4. Switch to „CITY POWER ON“.
5. Set timer. We recommend you start out with 60 minutes charging time. Battery charging begins as soon as the timer is set. Check condition of battery from time to time to avoid overcharging. If more charging is necessary, reset timer. Return timer switch to zero when battery is sufficiently charged.

### CAUTION

**Do not overcharge battery. This may cause the battery to boil over and thus result in damage to the plates.**

6. After battery is charged, return timer switch to zero. Disconnect vehicle from external electrical network.
7. Switch to **BATTERY ON**.
8. Reinstall cap on each cell of battery. Close engine lid.

### Fuse for refrigerator – 10 Amp. D.C.

The 10 Amp. D.C. fuse for the refrigerator is located in the lower part of the control panel.

When the fuse is blown, it is not sufficient to merely replace it. The cause of the short circuit or overload must be found. On no account should a fuse be patched up with tin foil or wire as this may cause serious damage elsewhere in the electrical circuit. It is advisable to always carry a few spare fuses in your vehicle.





**Fire Extinguisher\*** (only comes in combination with gas range).

A small dry chemical fire extinguisher is attached to the front wall of the rear bench seat.

**To use the fire extinguisher, release the metal bracket holding the bottle. Remove the tape over the white discharge button. Hold the extinguisher upright. Press the white button all the way down. Aim the spray at the base of the flame.**

**Do not test the fire extinguisher. Partial discharge may cause the contents to leak.**



**Gas Range\***

The gas range comes complete with hook-up to the refillable liquid propane tank under the vehicle.

Carefully read the operating instructions (separate pamphlet) for the gas range before use. **Observe all safety precautions as you would when using gas for cooking in your home.**

\* subject to change without notice. (Not available in Canada.)



To lift the sink and gas range cover, unstrap the straps first. When raised, the cover serves as a **backsplash**. Attach the cover to the valance with the straps. We also recommend you fold the driver's seat forward when cooking. Install the small removable table from the driver's cabin as a **sidesplash**.

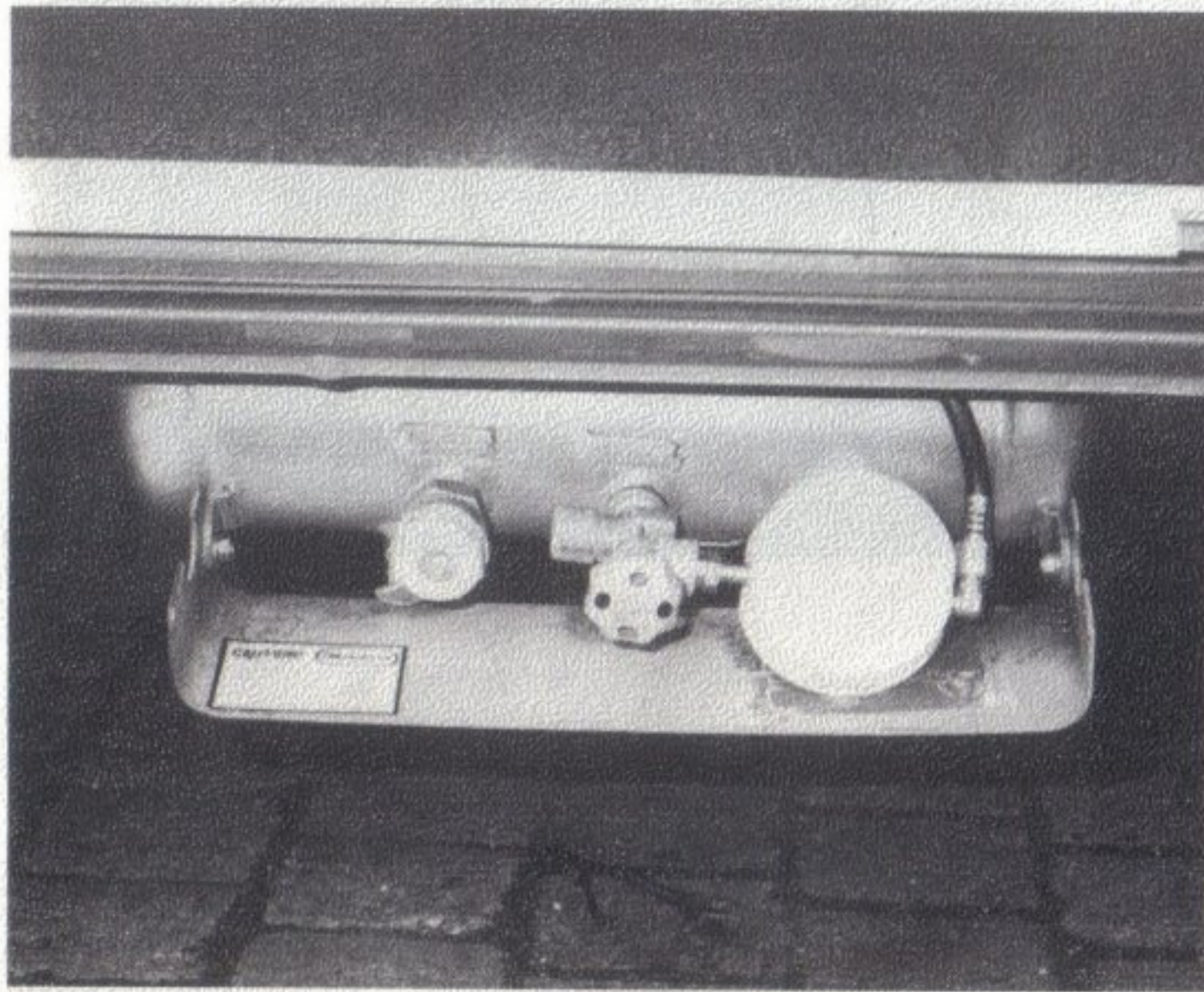

Instructions for refilling liquid propane tank are listed on the sticker and in a separate pamphlet.

#### Basic Safety Practices

- **DO NOT USE THE GAS RANGE WHILE DRIVING.**
- Keep combustible materials clear of the range when the gas flames are on.
- The burner orifices have been set by the factory for safe operating. Therefore, **DO NOT CHANGE THEIR SIZE.**
- Keep a lighted match ready when turning on the burners.
- Keep windows or door open when cooking. Gas flames consume oxygen.
- Make sure the gas tank is properly fastened in place.
- Check tank and lines from time to time to be sure they are tight. When testing for leaks, use soapy water. **DO NOT USE MATCHES.**
- **PRACTICE SAFETY AT ALL TIMES.**





### **Storage Box/Trash Container**

A combination storage box and trash container is installed between the driver's seat and front passenger's seat. The upholstered storage container can also be used as another seat around the dinette table or at the campsite.

The storage container is attached to the front seats by two retaining straps. **Do not sit on the storage container when the vehicle is in motion. The seat is not equipped with a safety belt or backrest.**

**Before you drive off, secure the storage container in place with the retaining straps.**



### **Removable Table in Driver's Cabin**

A small table can be installed in the driver's cabin between the front seats. It is ideal as a dining table for two children.

Before driving, remove the table and store it behind the driver's seat. Secure it in place with the rubber strap provided for this purpose. **The table should never be used while the vehicle is in motion.**



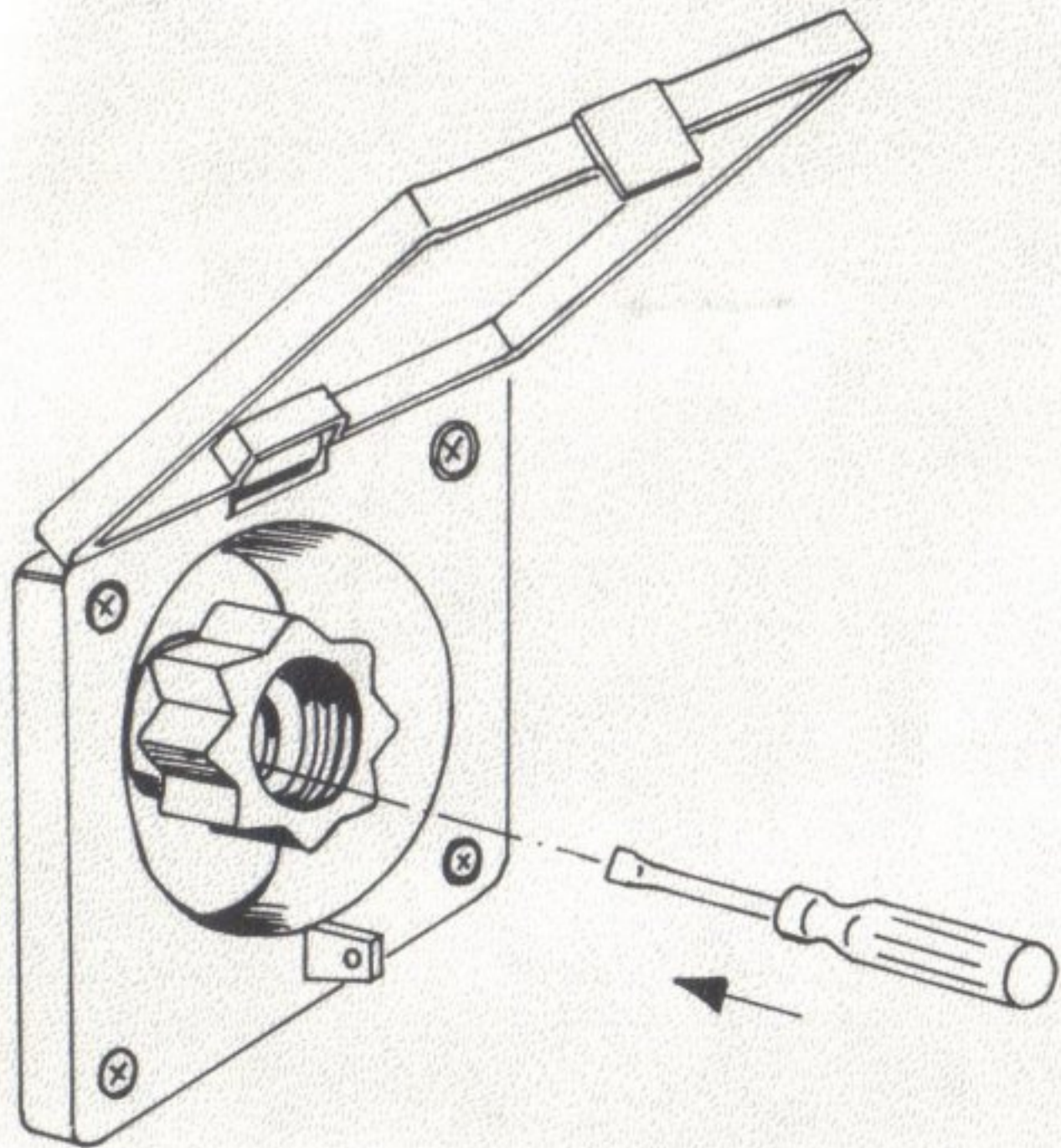

**Caution**

When danger of frost exists, make sure water is not left in the city water connection. Press screwdriver into valve opening until water is drained.

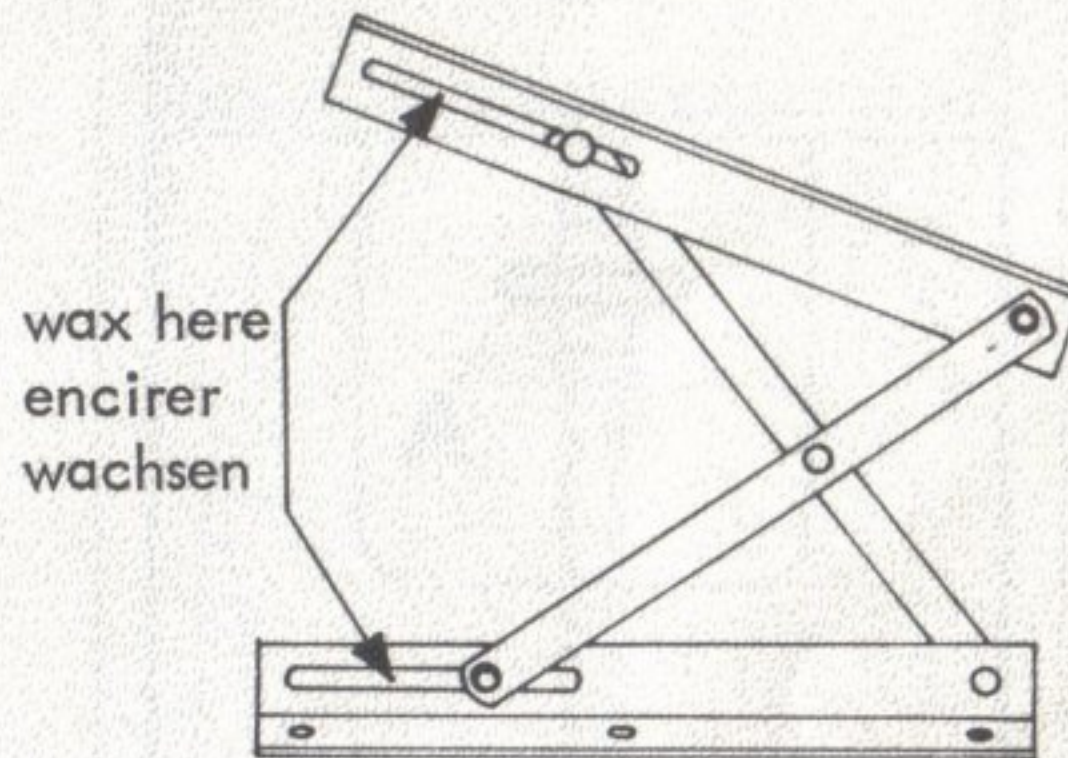

**NOTE**

The strut supports of the **Pop-Up Roof** have to be waxed on the running surface from time to time.

The hood and the luggage rack of the **Pop-Up Roof** can be cleaned with clear water or with a commercial polish as used for lacquered surfaces of the campmobile.



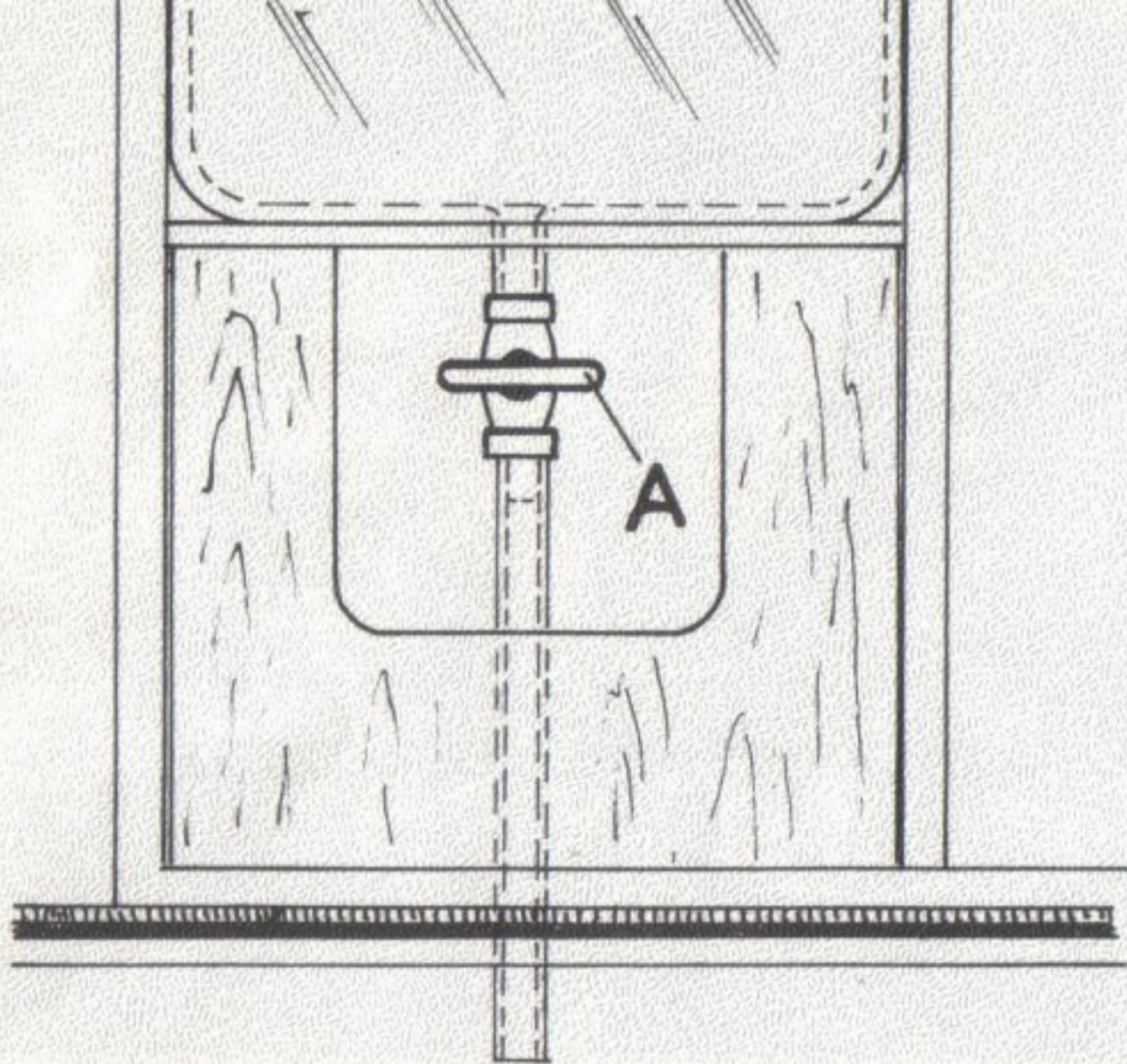

### **Shut-Off Valve under Watertank**

Before filling tank with water, make sure that lever (A) on the shut-off valve is in horizontal position.











## HINTS

### What to take along

Camping out can be a lot of fun, and to make sure you have a lot of fun, here are a few suggestions for your next trip. This list is not complete and can be tailored to your individual needs.

First-aid kit and first-aid manual.

Small dry chemical fire extinguisher.

Flashlight or lantern.

Three-prong power cord approximately 25' long (7.5 m).

Waterproof matches.

Folding shovel (entrenching tool).

Plastic bags for garbage disposal and odds and ends.

Water-purification kit.

A small saw may come in handy.

Lightweight nylon rope.

Sun-tan lotion and insect repellent.

Sewing kit.

Rain gear, just in case.

Folding campchairs.

Games and puzzles for the children.

### Cleaning your Campmobile

The cabinets and upholstery in your Campmobile can be cleaned by wiping them with a damp cloth. For heavy dirt and stains, use VW All-Purpose Cleaner available at your Authorized VW Dealer.

**Follow the instructions on the container.**

**When cleaning cabinets, floors and upholstery, never use gasoline, kerosene, naphtha, nail polish remover or any other volatile solvents. They may be toxic or flammable and therefore hazardous. Keep all cleaning agents out of the reach of children.**



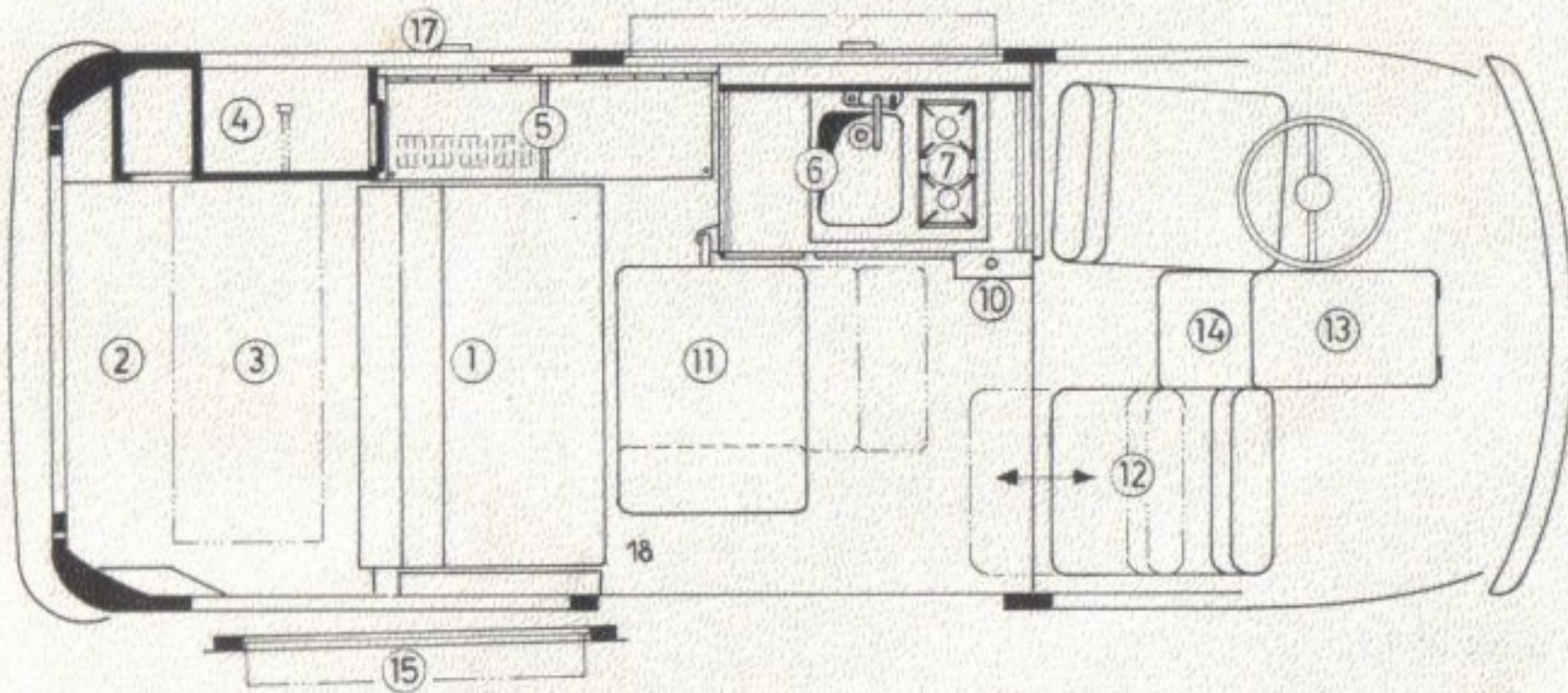

### BY DAY

- 1 – Rear bench seat.
- 2 – Mattress over engine compartment.
- 3 – Ceiling cabinet.
- 4 – Clothes closet. Linen closet with shelves.
- 5 – 1.1 cu. ft. (33 liters) icebox and storage chest.
- \* 5 – 1.1 cu. ft. (33 liters) refrigerator (12 Volt).
- 6 – Cabinet with stainless steel sink, water tank and 12-Volt water pump.
- \* 7 – Gas range (not available in Canada).
- \* 8 – City water hook-up.
- \* 9 – Cover for sink and gas range (backsplash).
- 10 – Spare wheel.
- 11 – Rotating dinette table with extension leaf.
- 12 – Swivel seat for front passenger.
- \* 13 – Small removable table in driver's cabin.
- \* 14 – Storage box/trash container.
- 15 – Louvered (jalousie) windows.
- 16 – Child's hammock.
- 17 – 110-125 Volt A.C. electrical hook-up receptacle.
- \* 18 – Fire Extinguisher (not available in Canada).

### BY NIGHT

1 and 2 combine to make the double bed  
 16 – Child's hammock

\* Deluxe Campmobile only

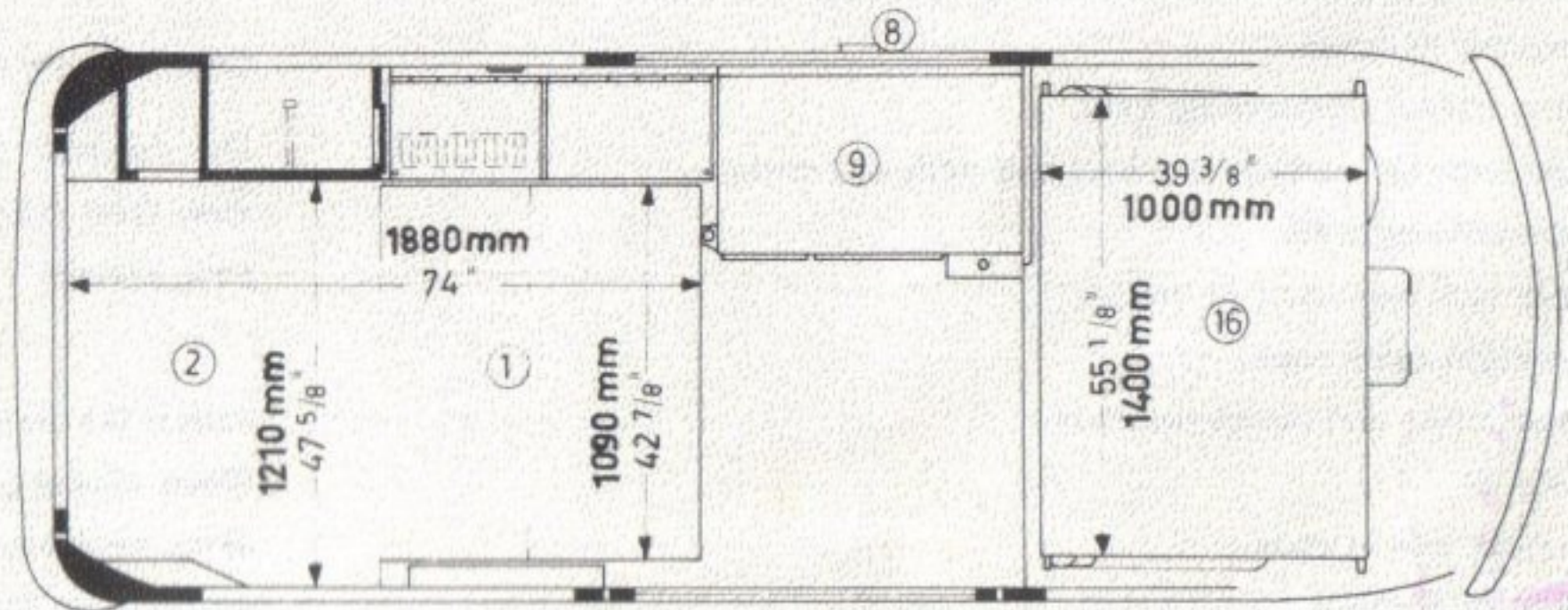



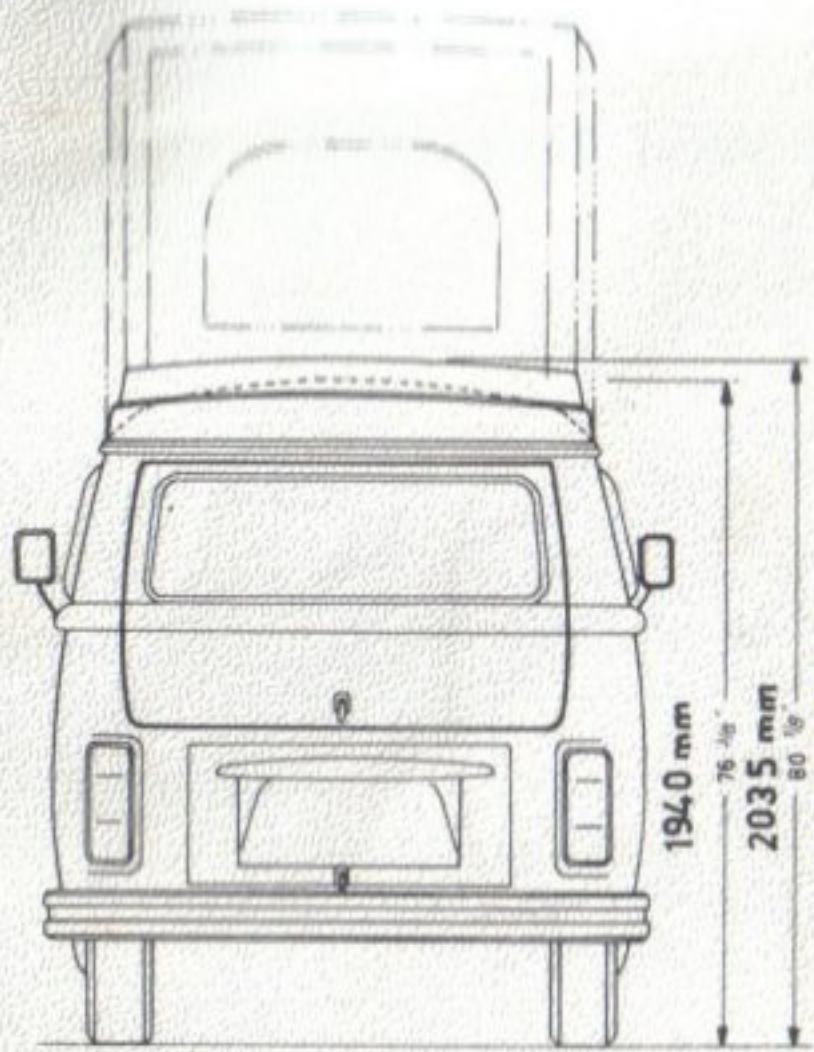

6'-8"

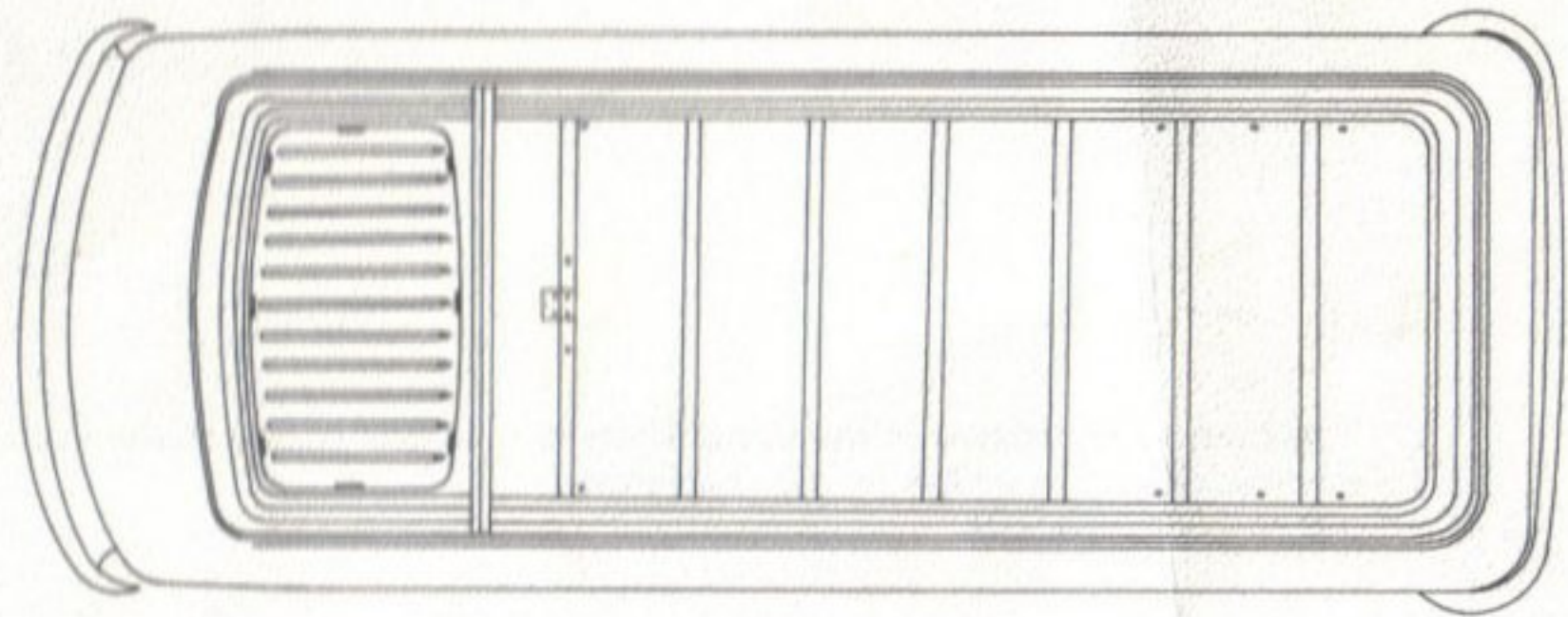
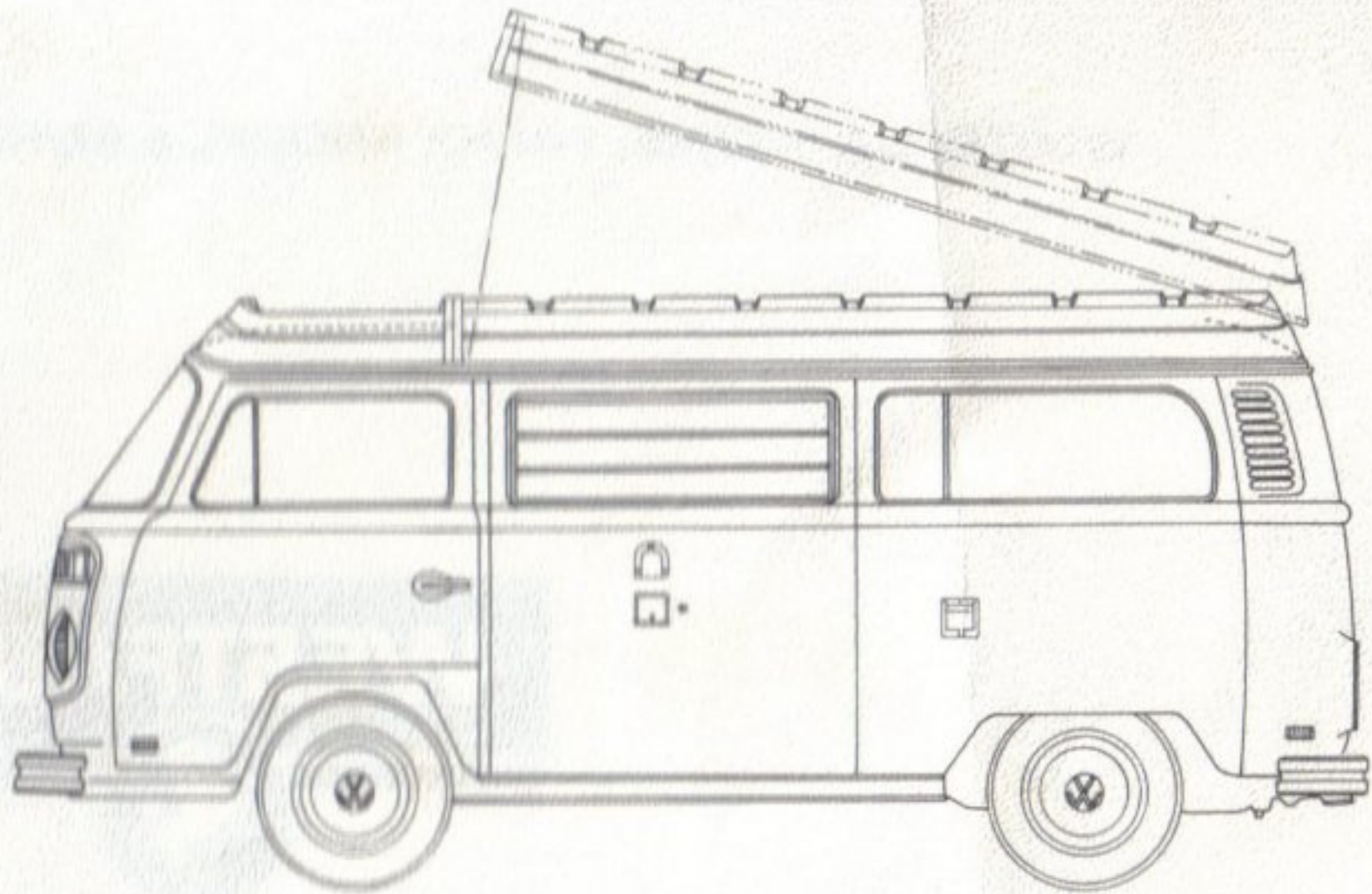



WESTFALIA-WERKE, FRANZ KNÖBEL & SÖHNE KG · 4832 WIEDENBRÜCK



May not be reproduced or translated in whole or in part without the written consent of Volkswagenwerk. Specifications subject to change without notice. All rights reserved.  
W 42 - 029 - 960 - 101

Printed in Germany 8. 78