

R. Shaw, 10 PEARSELL ST
W. BARYLON, NY

Instruction Manual



Sedan and

Convertible

Edition of August 1958

VOLKSWAGEN

Instruction Manual

Sedan and Convertible

Introduction	3
Controls and Instruments	5
Operating Instructions	7
Practical Driving	21
Cold Weather Hints	27
Lubrication	30
Wheels and Tires	38
Care of the Car	40
Maintenance	46
General Description	67
Technical Data	70
Lubrication Chart	75
Maintenance Chart	76
Index	77
Sectional View of Volkswagen	80

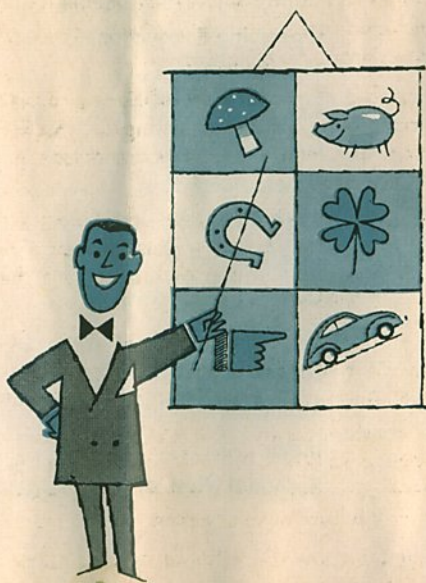

We are sure that the excellent performance and economical operation of your Volkswagen will justify the confidence you placed in our firm when purchasing this car.

This Manual sets out in full the information necessary for the proper operation, care and general maintenance of your car. In addition, interesting specification details have been included to familiarize you with the construction and mechanical details of this fine piece of mechanism.

No effort has been spared to produce an efficient and reliable automobile. This Instruction Manual can help you obtain lasting satisfaction in the operation of your VW. All information contained in this handbook is based on the actual experience of many years.

In order to maintain maximum efficiency, we particularly stress the importance of following the recommendations set out in this manual. The intimate knowledge obtained by studying this manual will assure you of the utmost service and satisfaction from your VOLKSWAGEN.

Regular attention to proper lubrication and maintenance of your car is important. An extensive network of VW Dealer exists throughout the world, and you will readily recognize such stations by the familiar blue VW SERVICE sign.

These Dealers are in constant contact with the Volkswagenwerk through our field engineers, thus providing skillful and factory-efficiency on any job from a tire change to a complete overhaul. You'll enjoy many more miles of trouble-free driving by giving your VW just ordinary care.

All experienced car owners know the value of preventive maintenance. The efforts in regard to care and maintenance will be amply rewarded in the long run.

Make the most of your VOLKSWAGEN!

VOLKSWAGENWERK GMBH

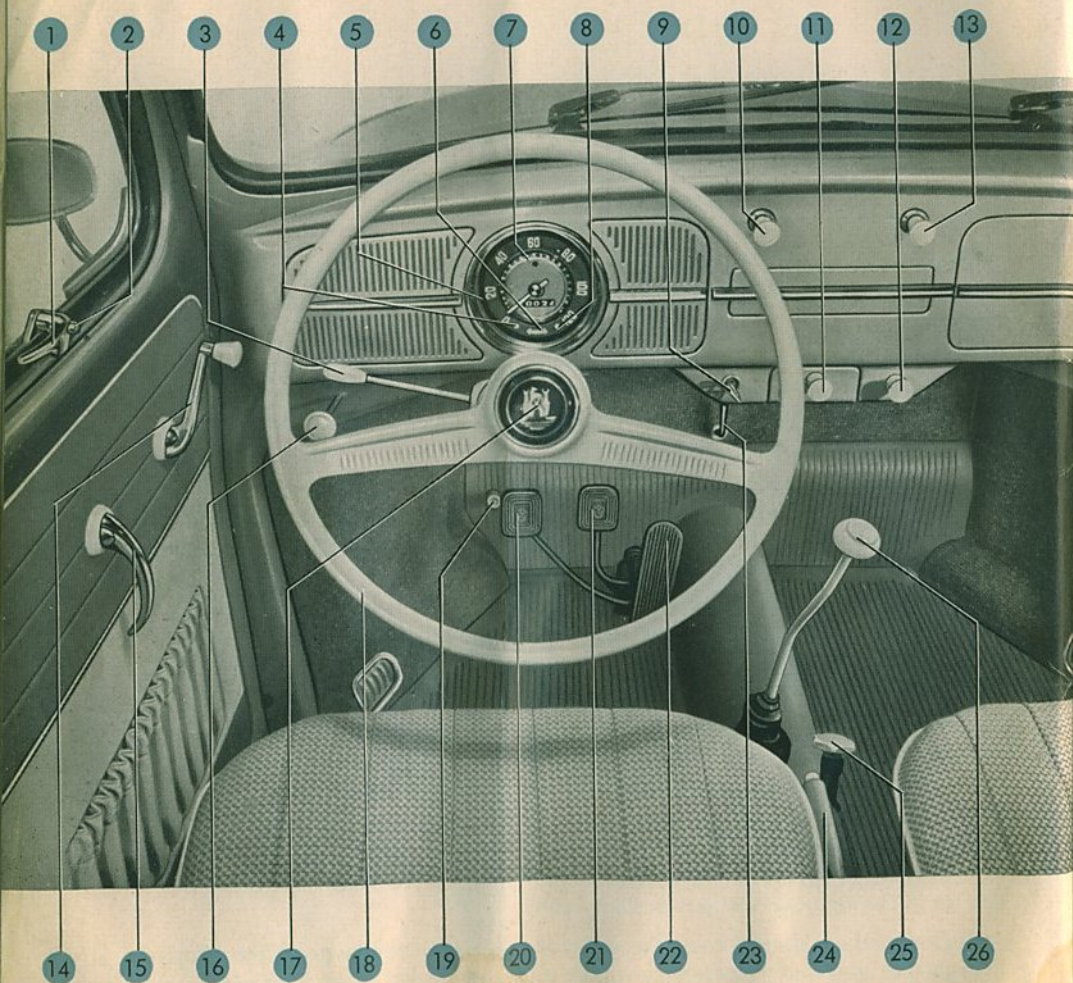

CONTROLS AND INSTRUMENTS

The first thing

you must do is become familiar with the controls and instruments of your new VOLKSWAGEN. Sit behind the wheel, make yourself comfortable, and get acquainted with all the various levers, switches, and controls. Some of the features you may already know. Check your present knowledge against this complete list.

Instruments:	Speedometer and odometer	5
	Warning light — Blue — Headlight high beam	7
	Warning light — Red — Generator and cooling	4
	Warning light — Green — Low oil pressure ..	8
	Warning light — Red — Direction indicators (dual arrow)	6
Foot controls:	Headlight dimmer switch	19
	Clutch pedal	20
	Brake pedal	21
	Accelerator pedal	22
Hand controls:	Combined ignition and starting switch	9
	Choke control	12
	Headlight and instrument light switch	10
	Windshield wiper switch	13
	Gear lever	26
	Hand brake lever	24
	Heating control	25
	Fuel tap	23
	Steering wheel	18
	Horn button	17
	Direction indicator lever	3
	Front hood lock control	16
	Inside door handle	15
	Window regulator handle	14
	Vent wing handle release button	2
Vent wing handle	1	
Ash receiver	11	

Among the papers which come with your car you will find details regarding the model, year of construction, and chassis and engine numbers. The Police or Traffic Department will check, as to whether the information on the papers is identical with that on your car.



The Identification Plate

is found behind the spare wheel, underneath the front hood.

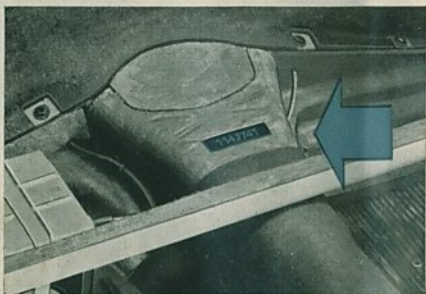

The Chassis Number

is found on the backbone of the chassis, underneath the rear seat.

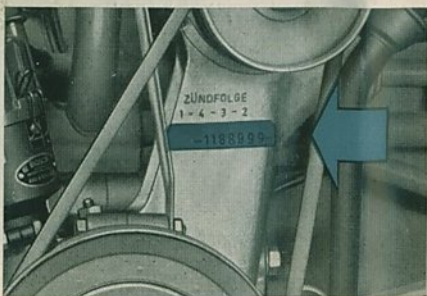

The Engine Number

is stamped on the generator support.

Only one Key

is required to unlock the door, switch on the ignition, and operate the starting motor. It is suggested that you record the key number so that you can order a duplicate from your dealer, should you lose or misplace the key.

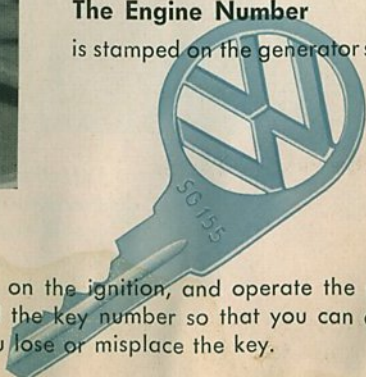

OPERATING INSTRUCTIONS

Before you drive away please check

engine oil level

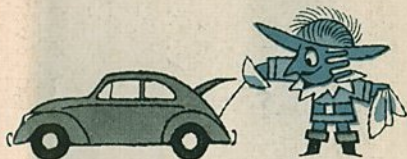

fan belt tension

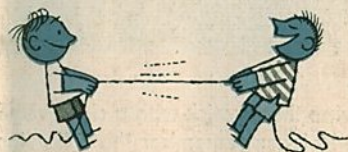

quantity of fuel in the tank



tire pressures



efficiency of brakes



and, if driving in fog or at night,
the exterior lights

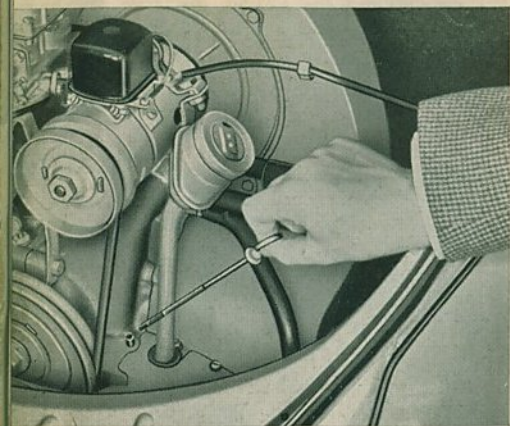

Engine Oil Level

The oil level should be checked when the engine is at rest. The oil level is satisfactory when it is between the two marks on the oil level dipstick, but it should never be

permitted to drop below the lower mark. To make an accurate check, it is best to wipe the dipstick with a clean rag beforehand. Should it become necessary to add oil please remember the following hints:

Most oils marketed at present contain chemical ingredients to improve their lubricating qualities. However, oils of different origin behave differently when used as engine lubricants and should, therefore, not be mixed.

Select an HD oil from among the well-known and dependable brands right at the beginning, and stick to it!

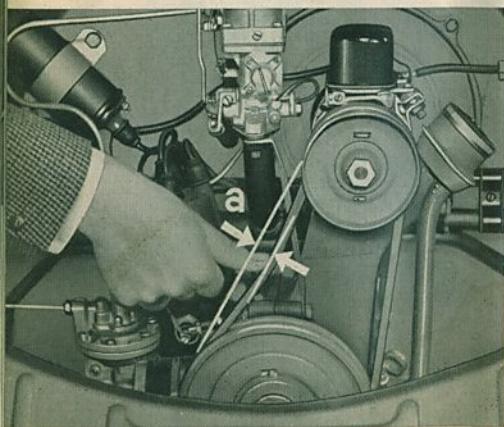

Fan Belt

The V-belt drives the generator and the fan of the engine. **Perfect condition and correct tension of the belt insure its long life and adequate cooling of the engine.** Checking is very simple: The belt, when pressed with the thumb at mid-point, should yield approximately 15 mm. (.6").

If you find any sign of wear, such as frayed edges, see your VW Dealer.

Even though the belt, when properly tensioned, has a long service life, a spare belt should always be carried along to meet any emergency that may arise.

Positions of fuel tap:

- 1 — Open
- 2 — Reserve
- 3 — Shut off

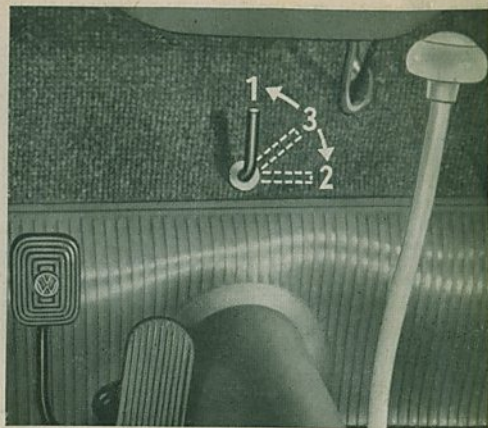

Fuel Tank

The tank has a capacity of 40 liters (10.5 U.S. gall., 8.8 Imp. gall.), sufficient for a drive of well over 500 kilometers (300 miles). Under normal conditions, the fuel tap should be set at position "1", while the car is in operation. If the engine begins to "stutter", as a result of lack of fuel, just turn the tap to "2". A fuel reserve of 5 liters (1.3 U.S. gall., 1.1 Imp. gall.) will then last for a further drive of about 60 kilometers (38 miles). It is important to re-set the tap at position "1" when refilling the tank, otherwise there will be danger of running out of fuel on the road. The fuel supply is shut off when the lever is set half way (45°) between the two end positions.

The VW Engine runs on all proven trade-mark fuels. Trade-mark fuels, including gasoline-benzol blends, comprise such characteristics as constant physical properties, sufficient anti-knock qualities and freedom from harmful constituents.

The selection of a particular grade and brand of fuel is therefore left entirely to your discretion.

The Tires

deserve and require your special attention. The riding comfort and the road-holding of your VOLKSWAGEN will greatly depend on their condition. Maintaining correct tire pressures and avoiding driving abuses are the most important factors in obtaining maximum tire life. Make sure the tires are correctly inflated, at least once a week, using a reliable tire gauge.



Here are the recommended pressures:

High speed driving conditions on long trips:

front 1.2 at. (17 lbs./sq. in.)

rear 1.6 at. (23 lbs./sq. in.)

Normal conditions:

Car occupied by 1 or 2 persons

front 1.1 at. (16 lbs./sq. in.)

rear 1.4 at. (20 lbs./sq. in.)

Car occupied by 3 to 5 persons

front 1.2 at. (17 lbs./sq. in.)

rear 1.6 at. (23 lbs./sq. in.)

The Brakes

should be checked before the car starts on a trip by pressing down on the brake pedal, while the car is in motion, to be sure they are in good working order.

Good Exterior Lights

are the first requirement of safe car operation at night. The three positions of the lighting switch are as follows:

- | | |
|------------------------------|--|
| 1 - Fully pushed in | — Off |
| 2 - Pulled out to first stop | — Parking light, tail and license plate lights |
| 3 - Fully pulled out | — Headlight upper or lower beams (depending on position of foot dimmer switch), tail and license plate lights. |

When pulling out the lighting switch knob either to the first or second stop, the instrument light is automatically turned on. By turning the knob, a variable degree of instrument lighting is obtained, turning the knob to extreme left turns out the light entirely.

When checking the lighting system, do not forget the two stop lights which should light up when depressing the brake pedal with the ignition turned on.

Starting the Engine

is easy, because you are now familiar with the various controls and instruments. However, make sure that the gear lever is in neutral position before starting the engine.

The ignition key starting enables you to start the engine by merely turning the key. First the ignition is switched on by turning the key to the right. The red generator warning light and the green light for the oil pressure will light up. To start the engine, the key is pressed against a spring load and turned clockwise until the starting motor operates. As soon as the engine fires, release pressure on key to disconnect starting motor.



Important! In cold weather the transmission oil is apt to become congealed. It is, therefore, good practice to declutch until the engine starts. Thus you will save the battery and facilitate the operation of the starting motor. You will never encounter any difficulties when starting your engine in the coldest weather, if you observe the rule of using the specified light grade engine and transmission oils.

To start cold engine,

pull out the choke control knob and operate the starting motor until the engine starts.

In severe frost, it is recommended to proceed as follows:

- 1 - Slightly depress the accelerator pedal several times.
- 2 - Fully pull out the choke control knob.
- 3 - Fully depress clutch pedal.
- 4 - Turn on the ignition and operate the starting motor.

As soon as the engine starts, slowly push in choke control knob (about half way) until the engine runs smoothly and evenly at fast idle speed without a tendency to stall (it is inadvisable to race the engine immediately on starting up from cold).

This position of the choke control knob permits a quick moving off without any detriment to the engine. Nor will harm be done to the engine when you drive for a longer period in dense city traffic with the choke pulled half way out.

As the engine attains operating temperature, you will notice an increase in the idling speed. When this occurs gradually push the choke control knob all the way in. This position must be reached before you make use of the full engine power on a free road. If the engine does not start within ten seconds, just repeat the procedure a few times, allowing a short interval between each successive attempt, as the battery is heavily strained by continuous starting motor operation.

To start warm engine

do not pull the chok control knob.

Slowly depress accelerator pedal while letting the starting motor operate. Do not pump the accelerator pedal.

It is important to note that pumping the accelerator pedal makes starting of the warm engine difficult and increases the fuel consumption.

Caution!

Be careful when starting the engine inside your garage. See that the door and windows are open so that the exhaust fumes can escape. They contain the colorless, tasteless and odorless, yet extremely poisonous, carbon monoxide gas.

Driving the Volkswagen

is extremely easy, if you observe the following points:

- 1 - Press down the clutch pedal as far as possible. Keep it in that position.**
- 2 - Shift to the first gear. Release the hand brake.**
- 3 - Engage the clutch by gently removing your foot from the pedal, while simultaneously pressing down the accelerator pedal. The car will start to move forward.**
- 4 - Gradually increase the pressure on the accelerator pedal and remove your foot completely from the clutch pedal, as the clutch is now fully engaged.**

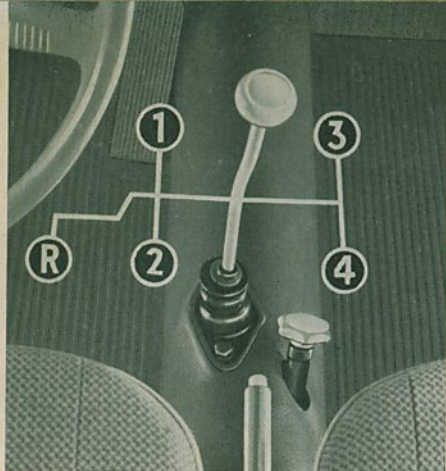

Shifting to second gear is equally simple

- 1 - Take your foot off the accelerator pedal, while simultaneously pressing down the clutch pedal.
- 2 - Shift gear lever into second position.
- 3 - Engage the clutch by taking your foot off the pedal gently and gradually and again step on the accelerator pedal.

You now know how to "shift gears", and may at will shift to third and fourth positions. You will have noticed by now that the accelerator and clutch pedals are operated simultaneously, but in opposite directions. It is the coordination of these simultaneous operations that brings skill in shifting gears.

To engage the **reverse gear** which should be shifted only when the vehicle is at a complete stop, first press the gear lever vertically downwards, move it to the left and pull it to the rear.

Shifting to a Lower Gear

This is what you should do in dense city traffic, or with sharp turns ahead of you, or when driving uphill.

With the De Luxe and Convertible

- 1 - Release accelerator pedal and depress clutch pedal.
- 2 - Shift to 3rd or 2nd gear respectively.
- 3 - Release clutch pedal and step on accelerator pedal simultaneously.

Of course, this goes much more quickly in actual operation than by describing it here. We do not want to bore you with a technical discourse, but it may be of interest to you to know that, when changing down, the synchromesh device assures

meshing of the gears without clash, as the lower gear is synchronized so that both gears are turning at the same speed.

When shifting gears, it is absolutely necessary to depress the clutch pedal fully. Incomplete declutching makes gear shifting difficult and leads to rapid wear of the synchronizer stop rings.

In order to save transmission and engine from damage shift down from

4 th to 3 rd between 47 and 25 m.p.h.

3 rd to 2 nd between 31 and 15 m.p.h. only.

The first gear is not provided with a synchronizing device, as the main drive shaft normally is not turning when the car is shifted into first.

Inexperienced drivers should shift from 2nd to 1st gear only when the vehicle is at a complete stop. **The experienced driver knows that to shift from 2nd to 1st**, the two cogwheels of the lower gear should be brought to the same ratio of speed by momentarily depressing the accelerator pedal with the shift lever in neutral position to insure an easy and silent engaging of the gears.

With the Standard Model,

shifting to a lower gear is done as follows:

- 1 - Release accelerator pedal and depress clutch pedal.**
- 2 - Place gearshift lever in neutral position.**
- 3 - Release clutch pedal and depress accelerator pedal at the same time, the amount of this intermediate feeding of gas depends on the speed of the car.**
- 4 - Depress clutch pedal and shift to lower gear.**
- 5 - Release clutch pedal steadily and at the same time step on accelerator pedal.**

After a short period of practice, you will take pleasure in the correct handling and shifting of the gears and obtain the utmost satisfaction from the efficient performance of your new VOLKSWAGEN! Under no circumstances should you be afraid to shift to a lower gear, or try to avoid shifting occasionally by merely letting the clutch "slip" in a partly disengaged position. Do not use clutch pedal as a foot-rest while driving your car.

Wait until the car is at a dead stop before engaging reverse.

Apply the brakes gently

The brake responds even to the slightest foot pressure. Increasing pressure will slow the car down progressively. However, avoid locking the wheels. Locked wheels will not shorten the braking distance but may cause you to lose control over the movement of the vehicle and will affect the tires adversely.

Here are a few rules on correct braking:

Use your brakes before, not while making a turn!

It is neither good practice nor is it economical to shift to a lower gear far ahead of a turn. Do not hesitate to use the brakes and to shift only shortly before entering the curve so that you may already accelerate again while still negotiating it.

To jam on the brakes suddenly can only be justified when danger is ahead. Nevertheless, it is necessary to check full braking capacity at certain intervals so that you will be familiar with the behaviour of the car and with the actual braking distance should sudden braking become necessary. Before carrying out the test, look into the rear view mirror to make sure that you will not endanger any vehicle that might be following you.

Operate the brakes especially gently when the road is wet or covered with ice. Sudden braking of the wheels will result in skidding of the car.

When driving downhill, make use of the braking capacity of the engine compression by shifting to that gear which you would use in driving uphill.

You will save and preserve the brakes if you use them only to control the speed occasionally, and at the same time you will attain a higher degree of safety. The ignition must never be switched off when descending grades.

Stopping the Car

Take your foot off the accelerator pedal and operate the brakes gently. Shortly before the car comes to a full stop, depress the clutch pedal, place the gear lever in neutral position and release clutch pedal again. The engine continues to idle. If you wish to stop the engine, merely turn the ignition key to the left.

The Front Seats

on the De Luxe Model allow an adjustment to suit individual requirements. Merely raise the adjusting lever and slide the seat either backward or forward

to the most convenient position. The seat rises as it moves forward, permitting short persons to sit higher.

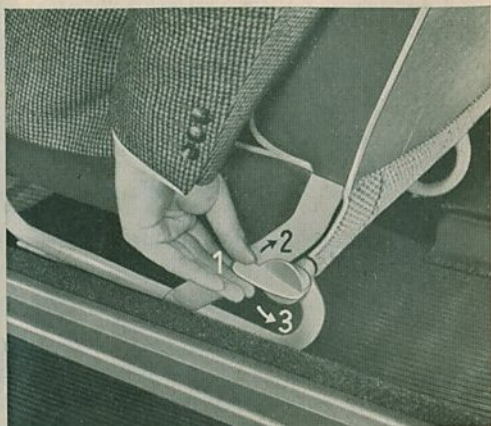

1 - normal 2 - backward 3 - forward

The rake of the front seat backs can be set at three positions by turning a lever. On the Standard, loosen the wing nuts to move front seats forward or backward.

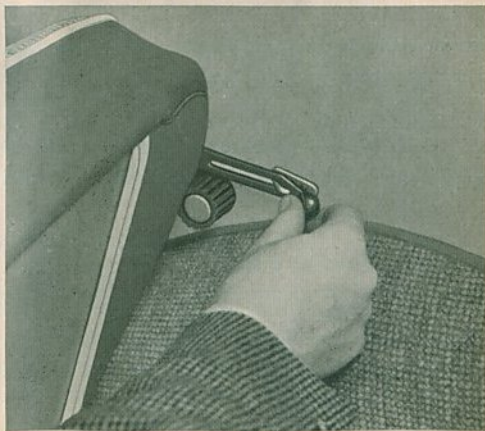

The Rear Seat Back

is held in place by a detachable rubber strap. Unhook the strap to tilt the seat back forward for loading or unloading luggage.

The Ash Receiver

below the instrument panel can be completely pulled out for emptying by slightly depressing the retaining spring.

On the De Luxe Model and the Convertible, a second ash receiver is provided in the right-hand rear quarter trim panel. To empty, lift the retaining spring and pull the container out. To reinstall, insert the tongue at the bottom of the container into the slot of the ash receiver frame.



The Interior Lamp

is automatically operated by opening or closing either of the doors (De Luxe Model). As an added convenience, the lamp may be operated by the manual three-position switch incorporated in the lamp fitting.

Positions of switch knob:

- Lower — On
- Intermediate — Off
- Upper — Door contacts

This allows the light to be turned off with the doors open.

The Convertible is equipped with a three-position tumbler switch below the instrument panel:

- Left — On
- Intermediate — Off
- Right — Door contacts

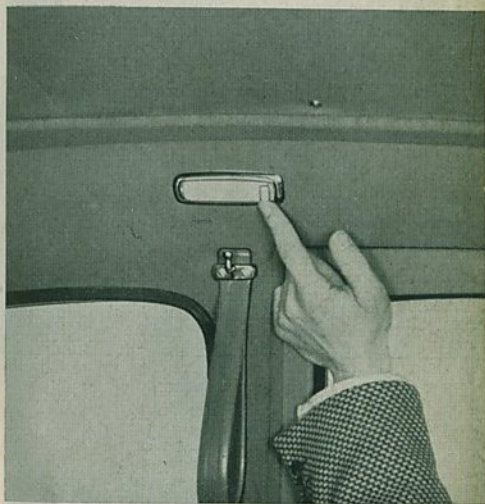

The Control Knob

for the front hood latch of the Convertible is equipped with a lock as an additional theft precaution. Thus, luggage, fuel and spare wheel are well protected with the top lowered. The key — which also serves for locking the door and operating the combined ignition and starting switch — should be turned anti-clockwise and removed immediately after

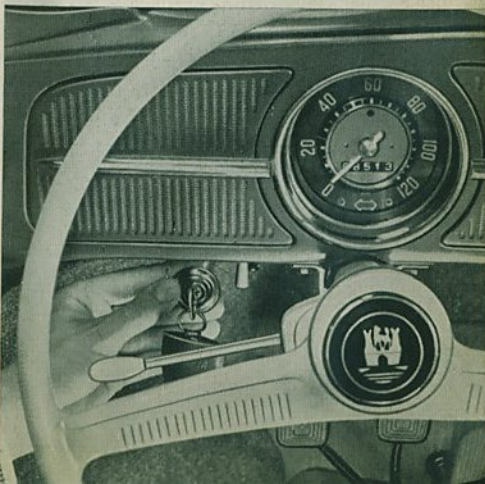

the control knob has been pulled out. When closing the front hood, the control knob and the hood latch are locked automatically.

A different key is provided for the glove compartment lock on Convertibles.

The Jack

is secured in position adjacent to the spare wheel by means of a quick release clamping strap. Also accommodated under the front hood are the tools and the spare fan belt.

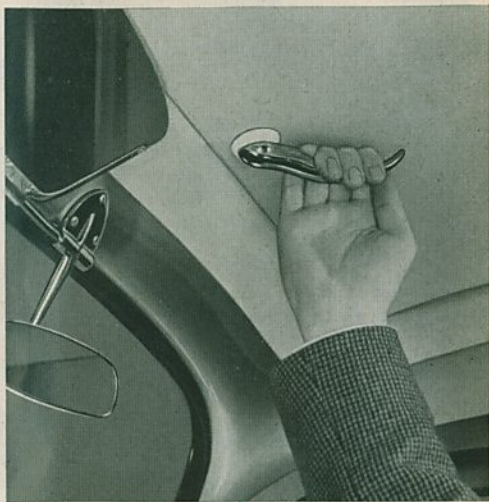
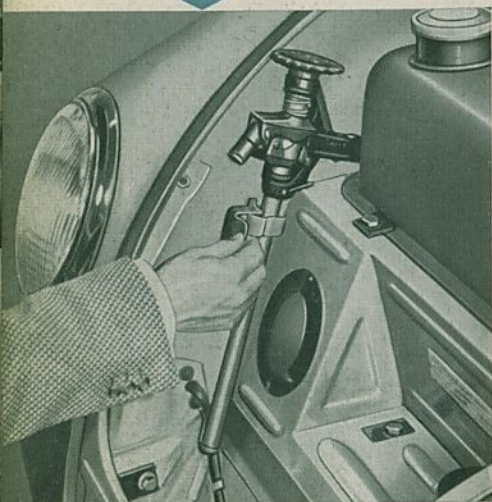

The Sun Roof

is free to slide by placing the locking lever to the left. It may be fixed in any desired position by merely moving the lever to the right. It is good practice, however, to open the roof fully prior to sliding it to the desired position. This will not only make the opened roof look better, but will also save the material by a proper folding. To close the sun roof, place the locking lever to the left, slide the roof forward until the locking hook engages the corresponding opening, and place the locking lever firmly to the right.

Misted Windows

can greatly obstruct the vision to all sides. This is caused by damp air in the car, breathing of the persons in the car and by low outer temperatures. By using the

vent windows intelligently sufficient fresh air can be provided while the used air is sucked out. Not only will the windows remain clear but so will your head.

The Convertible Top

can easily be lowered and raised by one person. The service life of the top largely depends on the way the top is lowered and raised. That is why we should particularly stress the importance of following the recommendations put forward.

To Lower the Top

- 1 - Pull the two clamps above the windshield downward to unfasten the top (A).
- 2 - Raise the header slightly and fold back the top.
- 3 - Withdraw top cover from the linkages on both sides (B).
- 4 - Push the top lining inward so that the linkages are free (C).
- 5 - Press down the top until the spring-loaded catches (one on each side) engage in the slots cut in the side rails (E).
- 6 - Place the caps of the top clamps over the header guides and press down the levers (D).
- 7 - Install the top boot from the rear and secure it with the snap fasteners. The top cover should be perfectly concealed by the boot, paying particular attention to the bottom part of the boot. The ornamental strip at the top cover rear edge should be visible.

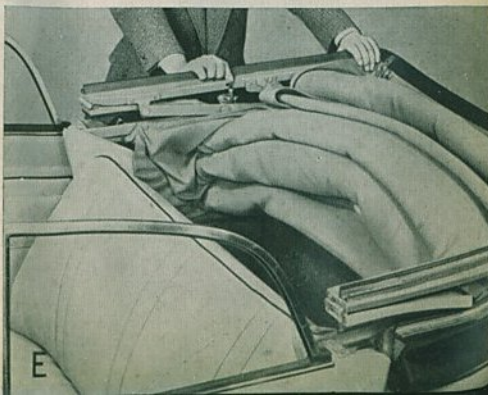
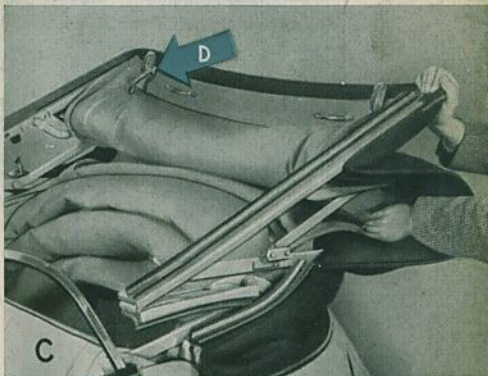
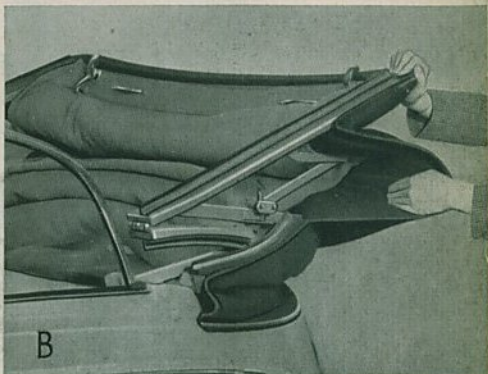

To Raise the Top

- 1 - Unsnap the fasteners of the top boot and remove the boot. The boot can best be stored in one of the two luggage compartments.
- 2 - Turn up the clamp levers.
- 3 - Press down the top and disengage the catches.
- 4 - Raise the top.
- 5 - Pull down the top, until the header guides have entered the channels above the windshield frame.
- 6 - Place the clamp caps over the noses of the brackets and turn up the levers.

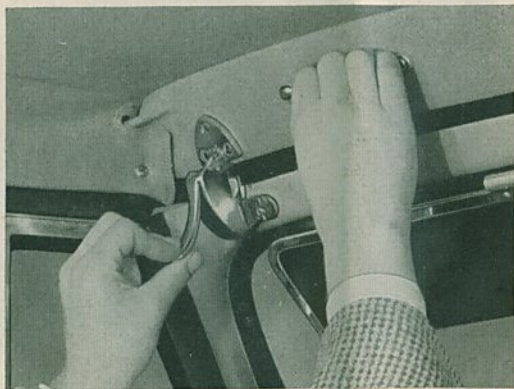

1st gear



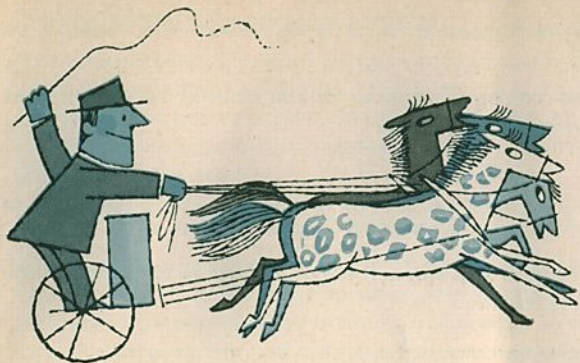

PRACTICAL DRIVING

Breaking-in (running-in) Period

does not imply inconvenience as your Volkswagen needs no "breaking-in".

Progressive refinements have raised the VW engine to its present predominant position and it is these refinements which allow an omission of breaking-in instructions. Your car may be operated right from the beginning at the full speeds recommended for the gears.

1st gear	0	— 15 m. p. h.	(25 km. p. h.)
2nd gear	6 (10)	— 30 m. p. h.	(50 km. p. h.)
3rd gear	15 (25)	— 45 m. p. h.	(75 km. p. h.)
Top gear	25 (40)	— 68 m. p. h.	(110 km. p. h.)

The upper speed limits of the 1st, 2nd, and 3rd gears are marked in red Roman numerals on the speedometer dial.

2nd gear



3rd gear



4th gear



The life of your car, its performance, and its operation will depend on your driving habit.

Maximum satisfaction in the running of your car will be assured by following the fundamental rules for driving an automobile:

Do not unnecessarily race the engine, no matter whether the car is stationary or in motion.

The new engine is not governed. Therefore, it is good practice to glance at the speedometer hand from time to time.

Do not allow the engine to labor by driving at too low speeds.

Don't think that your engine will be saved and preserved most when it is operated at low speeds. You won't reduce the fuel consumption either. The VW engine requires air for cooling, which it gets when it is running fast enough. It is overloading and overheating that is harmful to the engine, but never high speed operation.

When driving uphill

always change gear as soon as the speed drops and the speedometer hand approaches the maximum speed limit of the next lower gear. Never allow the engine to labor in 4th gear, which is nearly an overdrive, and still expect it to pick up speed on feeding more gas.

Economical operation

is one of the outstanding features of your car. However, getting a few extra miles from each gallon depends on the manner in which you handle the car and shift the gears.

When accelerating,

step on the accelerator pedal slowly and only to such an extent as is necessary for reaching the desired speed. Depressing the accelerator pedal rapidly does not improve acceleration, but results in an increased fuel consumption.

Do not "pump" the accelerator pedal

unless circumstances require it. Even the small quantity of fuel additionally discharged by the accelerator pump each time the accelerator pedal is depressed results in a marked increase in the overall fuel consumption.

Operate your car smoothly and flexibly,

both when driving in city traffic and on main roads. Adapt the speed of the car to prevailing road and traffic conditions. A good driver accelerates the car gradually, slows down in time, and utilizes the braking power of the engine. Make use of the full acceleration capacity and the excellent brakes of your car only when you really need to.

How to drive at high speed without sacrificing fuel economy

When you have accelerated the car to the desired speed, slowly let the accelerator pedal return to the position which just maintains this speed. This practice is especially economical when driving on highways. If you attach particular importance to the economy and also to a fair average speed, it is important to determine a compromise in the choice of the cruising speed in the interest of fuel economy. The chart illustrates the manner in which fuel consumption increases in relation to the speed; it increases more rapidly at higher speeds.

Perhaps you are aware of the fact that air resistance is an obstacle for all high-speed vehicles. Due to the simple and sweeping lines of your VOLKSWAGEN, air resistance is relatively low, but it should be remembered that high road speed always involves a greater fuel consumption.

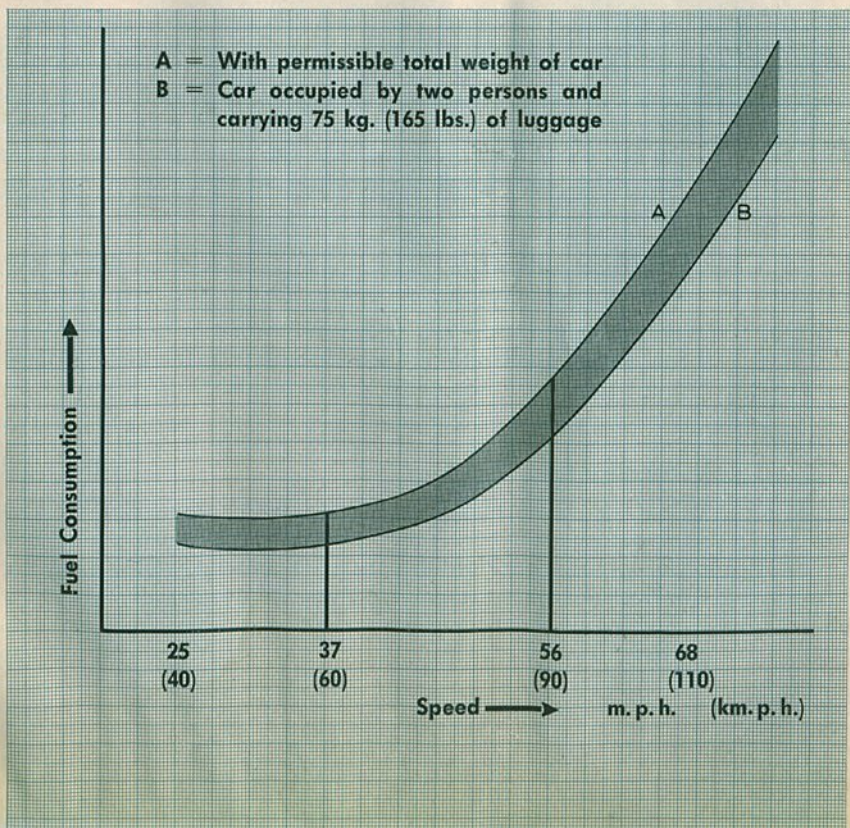

Watch the Road

closely while driving. As to using the various levers, switches and controls, you now are able to operate them automatically. Furthermore, your VOLKSWAGEN on its own accord will "tell" you when it needs attention.

Generator and Cooling

Red Light

are controlled simultaneously by a red light. The light will show when the ignition is turned on and when the engine is running at low speed. The light should go out when speed is increased.

Caution! If the red light goes on while you are driving the car, the fan belt may be broken. Bring your car to a stop, and find out what is wrong, for if the belt is broken, the cooling is disrupted and the generator no longer charges.

Oil Pressure

Green Light

The oil pressure of your car is as important as the oil level, which you have already checked. When the ignition is turned on, the Green Oil Pressure Light will go on. The light should go out when the engine is started and the oil pressure increases.

Caution! If the green light goes on with the engine running, the chances are that the oil circulation has been interrupted, which means that the lubrication of the engine has ceased. Stop at once and check the level of the oil before you consult a Service Station. An occasional flashing of the lamp with the engine warm and at low speed does not indicate trouble, if the light goes off again as the speed increases.

Direction Indicators

Red Arrows

The direction indicators lie outside the driver's view. However, the red light with the two arrows will serve as a reminder in case you have forgotten to turn the indicator off. The direction indicator switch can be operated without taking the hand off the steering wheel.

Headlights

Blue Light

The high beam of your headlights throws glare into the eyes of oncoming drivers. You know yourself how unpleasant and dangerous this is. For this reason, be considerate! The blue light will tell you when the upper beam is switched on. Just step on the dimmer switch to transfer the headlights from upper to lower beam.

Safety First

Safety for yourself, and safety for others, this is what counts most! Your VOLKSWAGEN is a car that "hugs" the road in an excellent way, and does not roll when taking a turn. Your car has an extraordinary capacity for acceleration. Yet, the feeling of security and safety which you will acquire after a few miles should not tempt you to become careless.

Therefore, adjust the speed of your car to the conditions of road, traffic and weather, and always be ready to bring your car to a stop when it is necessary. Be particularly careful when driving on wet or icy roads, for even a VOLKSWAGEN is apt to skid when not driven carefully under such conditions.

Rear View Mirrors

can be adjusted to suit individual requirements.

Adjust the outer mirror so that you can look rearward alongside the car without having to turn your head or shoulders. You will then get a clear view of the road behind you.

The inner mirror of the Convertible is adjustable to insure a perfect view no matter if the top is lowered or raised.

With the top in the raised position, turn the mirror holding rod down and push the mirror toward the windshield until the stop can be felt.

With the top lowered, pull the mirror back until the stop can be felt and turn up the holding rod.

Passing Other Cars

Pass other vehicles with consideration. Always be sure that the road is clear ahead of you, and look out for cars approaching you from the opposite direction. A brief look in your rear view mirror will tell you whether another car is about to pass you from behind. And here is another warning: Never try to pass a car when approaching a curve, where vision is not clear, and never pass a vehicle at the crest of a hill, or at crossroads! You never can tell what lies ahead of you!

Be fair and do not step on the gas pedal when another car tries to pass you. You will endanger your life and others!

Stopping Your Car Temporarily

When stopping your car in front of a traffic light or railroad crossing, do not wait for free passage with the clutch pedal pressed down and the gear lever in position! Shift to first gear shortly before moving on again, it will preserve the clutch!

Parking your Car

in a space between two other cars that are parked at the curb will be fun for you if you heed the following advice:

Stop your car level with the car in front of the space. Turn the steering wheel sharply to the right and back your car slowly into the gap.

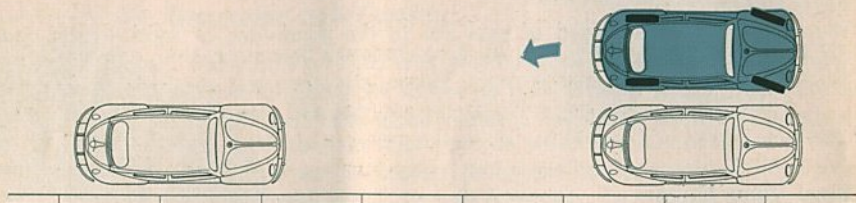

When the front bumper of your car is even with the rear bumper of the car ahead of you, turn the steering wheel fully to the left, and back up further toward the curb.

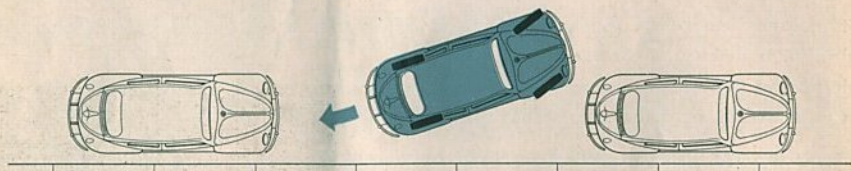

Now turn the steering wheel again to the right and pull up a little bit, until both ends of the car come as close to the curb as possible.

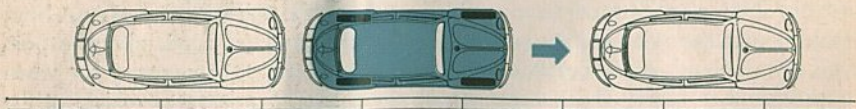

When parking on a steep grade, set the handbrake so as to keep the car from rolling. As a precautionary measure, it is advisable to engage first or reverse gear in addition to the handbrake. And do not forget to take the key out of the ignition switch before you leave your car!

Do not forget to shut the fuel tap when parking on a grade with the rear end of the car downwards.

Prior to locking the left-hand door secure the right door by pushing the inside door handle forward. The vent wing handle is locked by turning it to the position when the push button is heard to spring out.

COLD WEATHER HINTS

In Winter

there are two advantageous features of your VOLKSWAGEN that you will appreciate most:

Air Cooling and Heating

You may expose your car to bitter cold without fear: — its air-cooled engine will always be ready to start! You will drive in warm comfort, well protected from drafts and from sleet and snow, while a current of warm air will keep your windshield free from condensation and frost, permitting you a clear view. The increased stress that your car has to stand in winter because of frost and dampness can be easily dealt with if you observe the recommendations presented in this section.

Never attempt to influence the cooling and heating of your car in winter by covering the air intake slots below the rear window. This would be harmful to the engine, as the drawing in of fresh air for the carburetor and the heating would be seriously affected. The intake of cooling air is already efficiently controlled by the thermostat.

The Warm Air Heating

of your car can be regulated by a rotary knob situated adjacent to the gear lever:

- Anti-clockwise — On (1)
- Clockwise — Off (2)

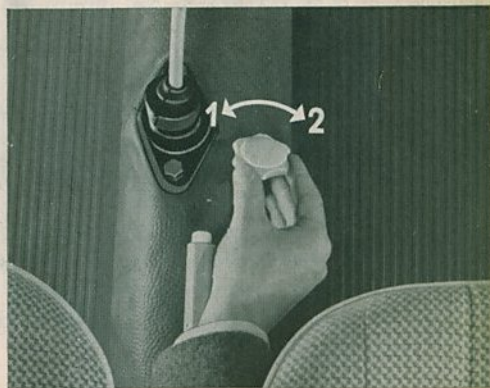

Heating of your car will take place more quickly if you open a vent wing window so that the blower can more easily force the warm air into the otherwise tightly sealed interior.

Engine Oil

SAE 20/20 W oil will not congeal at temperatures above 0° C (+ 32° F) and will permit easy starting of the engine. If, however, the anticipated atmospheric

temperature during the interval in which the oil will remain in the crankcase is below freezing point, it is recommended to use SAE 10 W oil.

This grade oil may remain in the engine with safety when the temperature again rises to a higher range. Should it become necessary to add oil in the period between two regular oil changes, SAE 10 W oil may be used at lasting frost and SAE 20 oil when the temperature average rises. This means that the grades SAE 10 W and SAE 20/20 W can be mixed without involving any disadvantages, but be sure to use always the same brand and type of engine oil.

In extremely cold weather, allow the engine to idle for half a minute before driving away to insure correct oil circulation.

Don't race the engine in severe frost to obtain a quick start.

Only if your car is mainly operated over short distances **during cold weather** it is recommended to have the oil changed at more frequent intervals, say every 2,500 km. (1,500 miles), using the right HD oil. In the warmer season, oil changes in addition to those laid down in the Lubrication Chart are unnecessary and uneconomical.

In territories where exceptionally low temperatures prevail (below -25°C / -13°F), it is recommended to use SAE 5 W engine oil, which should be changed every 1,250 km. (800 miles). The oil strainer should be cleaned at the same time.

Transmission Lubricant

SAE 90 gear lubricant is recommended for use when the average temperature range will not be lower than 0°C ($+32^{\circ}\text{F}$). However, where the temperature is expected to remain below freezing point for an extended period of time, SAE 80 grade should be used.

If your car is a Standard Model, you will find from experience that during the winter months shifting to higher gears must be done with shorter pauses, until the gear lubricant has warmed up, because the stiff lubricant has a higher braking effect on the gears.

The Chassis

is particularly exposed to moisture in winter. For this reason it will be necessary, and only logical, to adhere strictly to our instructions for lubrication. If, in addition, you spray the bottom of the car with a special chassis oil, as a protection against rusting, you will prolong the life of your car.



The Brakes

of all automobiles are exposed more or less to splashing water which in winter is apt to freeze in the brake drums. Therefore, when parking your car, do not set the hand brake, but shift to first or to reverse gear. At the beginning of the cold season, the conduits of the brake cables should be thoroughly lubricated with anti-freeze lubrication grease. Do not use just any carlubricant, but get the right one from any VOLKSWAGEN Dealer!

Tires

Worn off tires are apt to cause trouble in winter. To assure a safe operation, replace them in time. To meet the special requirements in winter, so-called M+S tires are available. These special-tread tires are designed to give a better grip on mud and snow. They are either used on the rear wheels only or on all four wheels. However, during the rest of the year you should rather use the usual tires.

Non-Skid Chains

You will need non-skid chains only when the roads are covered with snow or ice. Without such chains, the rear wheels of your car are apt to spin, and applying the brakes may result in the car skidding. Have the non-skid chains adjusted to the wheels, if you wish to avoid loss of time and inconveniences later on!

When driving on long stretches that are free from snow, the chains should be removed to prevent excessive wear of both chains and tires.

The Battery

is under greater strain in winter than in warmer seasons because of the increased consumption of current when starting the engine and using the lights at night. Besides this, it is a characteristic feature of any battery that its efficiency decreases at lower temperature. If the car is mostly operated over short distances, the battery may call for an additional recharging.

Therefore, have your battery checked regularly, and you will never encounter any starting difficulties.

Spark Plugs

will aid cold starting substantially in extremely cold weather when reducing their gaps to 0.4—0.5 mm (.016"—.02").

When seasonal temperatures rise, or when the car is to be driven in areas where higher atmospheric temperatures are encountered, reset the spark plugs to their normal gaps of 0.6—0.7 mm (.024"—.027").

LUBRICATION

Proper Lubrication is of Vital Importance to Your Volkswagen

The extra time spent in following these recommendations will be amply rewarded in the long run by your car's efficient performance. It is up to you to maintain the standard of safety offered by your VOLKSWAGEN, and to insure the long life and good service which you have the right to expect from this truly economical car!



To lubricate correctly means to lubricate amply and at prescribed intervals!

Therefore, do not shy at the work connected with the regular lubrication service. A Lubrication Chart can be found on page 75, indicating the respective mileages at which to lubricate.

Our Service Policy makes it possible for you to have your VOLKSWAGEN lubricated at our authorized workshops by skilled hands, with the best available lubricants, at lowest cost and in a minimum of time. You really cannot afford to miss this opportunity!

Engine Oil Change

Regular oil changes are necessary even if the very best trademark oils are used. Diluted and dirty oil in your engine simply means a greater strain on and a shorter period of life for your engine. On the other hand, provided that HD oil is used, it is unnecessary and uneconomical to change the oil more frequently than called for in the Lubrication Chart.

The oil is drained by removing the plug at the bottom of the crankcase. To insure complete draining, it is important that the operation be performed while the engine is warm.

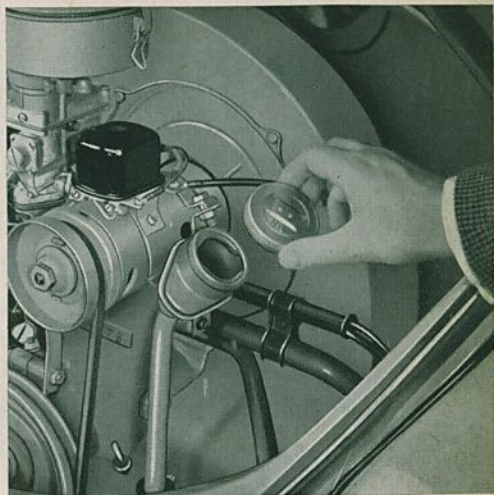
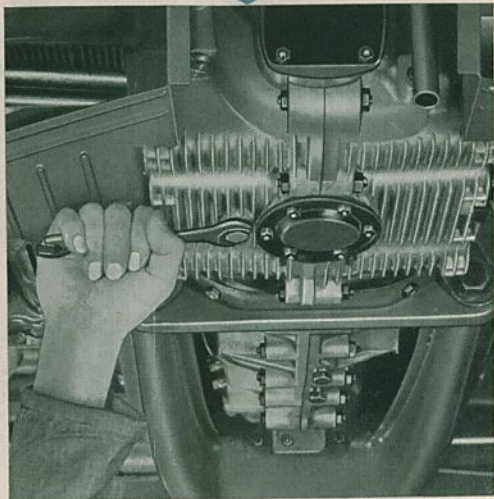

The engine is refilled with **2½ liters of HD oil** (for Service MS)
(5.3 U.S. pints, 4.4 Imp. pints)

Flushing of the engine is unnecessary.

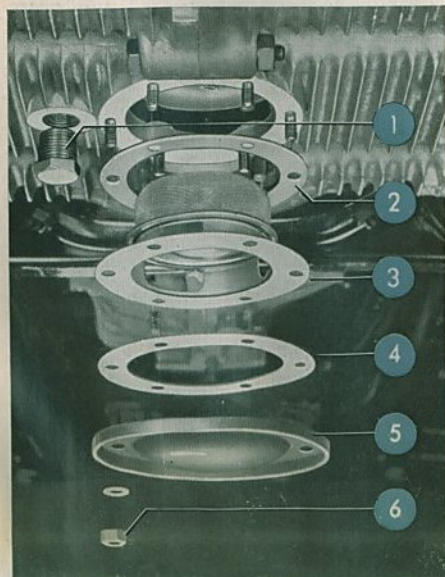

The Oil Strainer

retains foreign matter and should be taken out and cleaned as called for in the Lubrication Chart. The two gaskets be replace each time the strainer is removed.

- 1 - Drain plug
- 2 - Gasket
- 3 - Oil strainer
- 4 - Gasket
- 5 - Bottom plate
- 6 - Nut and lock washer

Types of Lubricant and Recommended Usage

The advantages of using a

trade-mark HD engine oil (for Service MS)

HD oil is an oil having proved oxidation stability, bearing corrosion preventive properties and detergent-dispersant characteristics which tend to hold in suspension foreign contaminants which would normally deposit on engine parts. These foreign contaminants will drain out with the oil at the periodical oil changes. The detergent properties of HD oil will make the fresh oil darker after a short time of operation. This is quite natural and there is no reason whatsoever to change the oil earlier than called for in the Lubricant Chart.

Additional lubricating agents should not be added to HD oil.

Some more Information on Engine oils

It is left to your discretion to select an oil from well-known and dependable brands of the proper viscosity to suit your seasonal and driving requirements. In cases of doubt, refer to your authorized VW Dealer who will be glad to help you with your lubrication problems. It is recommended that you select "your" oil right at the beginning and stick to it at all future service oil changes. Viscosity of the lubricant is an indication of its resistance to flow at a given temperature. The SAE numbers classify lubricants in terms of viscosity, but with no reference to other characteristics or properties.

SAE 30 engine oil is satisfactory in tropical climates where the temperature range will frequently rise above 30° C (86° F).

SAE 20/20 W engine oil is recommended for use within the mild temperature range from + 30° C to 0° C (+ 86° F to + 32° F). It may also be used with safety, should temperatures temporarily exceed these limits.

SAE 10 W engine oil is recommended for use if the atmospheric temperature is anticipated to fall below 0° C (+ 32° F). It may also be used with safety, should temperatures rise above freezing point. A change of oil is, therefore, not necessary until the next regular mileage interval.

SAE 5 W This extremely light engine oil is for use in arctic climates below — 25° C only.

In some countries API Classification is applied (API = American Petroleum Institute). According to this classification, the oils suitable for the VW engine are referred to as "For Service MS".

Ignition Distributor

The amount of grease at the breaker arm fiber block should be checked and, if necessary, replenished at the specified intervals.

Every 25,000 km (15,500 miles), apply 2 or 3 drops of oil to the felt in the cam bearing after the rotor is taken off.

Transmission and Differential

The transmission gears and the differential of your VOLKSWAGEN are combined in the transmission case and are both lubricated with the same gear oil. This kind of oil can be readily distinguished from motor oil by its heavier viscosity and darker coloring. An early change of oil, while the gears are being broken in, will contribute to a smoother operation of the transmission. The used oil should be drained by simultaneously removing the two magnetic drain plugs, while the oil is still warm.

The magnetic oil drain plugs should be carefully cleaned at 500 km. (300 miles), 2,500 km (1,500 miles) and 5,000 km. (3,000 miles) and then regularly every 5,000 km. (3,000 miles).

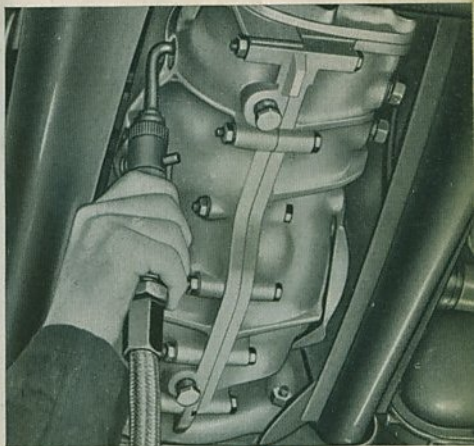
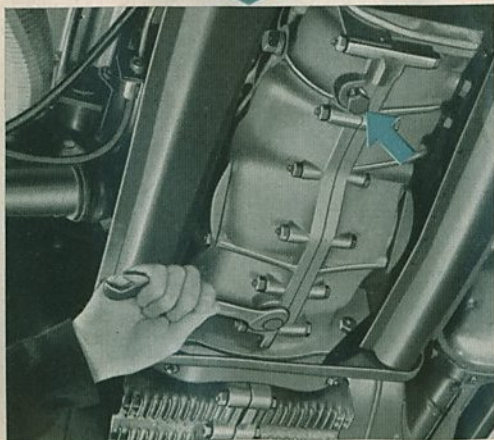

Then refill with 2 liters (4.2 U.S. pints, 3.5 Imp. pints) of gear oil.

Do not drain the oil when merely a cleaning of the oil drain plugs is in order. Instead, first remove one drain plug and close the drain hole temporarily with a spare plug or a wooden plug, and then proceed in the same manner with the other drain plug. Then check the oil level. Keep the lubricant level somewhat below the edge of the filler hole.



In order to maintain the characteristics of the gear oil, it should not be mixed with any other oil, as the two will not blend.

Steering Gear

The steering assembly should be lubricated with gear oil, SAE 90, exclusively, and under no circumstances with grease or hypoid oil. It is accessible through a hand-opening underneath the spare

wheel. The level of the oil in the steering case should be kept somewhat below the filler plug hole.

Chassis

Proper lubrication of the front axle bearing points is best done by raising the front axle so that the weight is taken the wheels.

Prior to lubrication, the grease fitting should be cleaned thoroughly with a clean

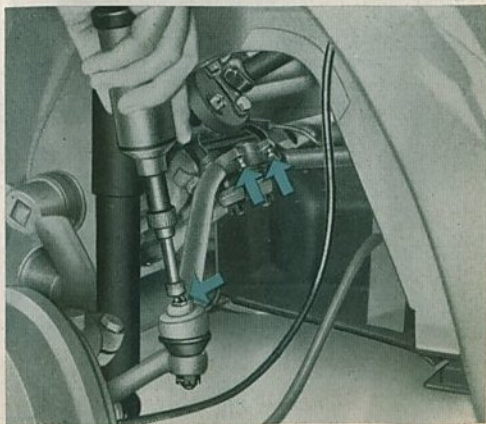
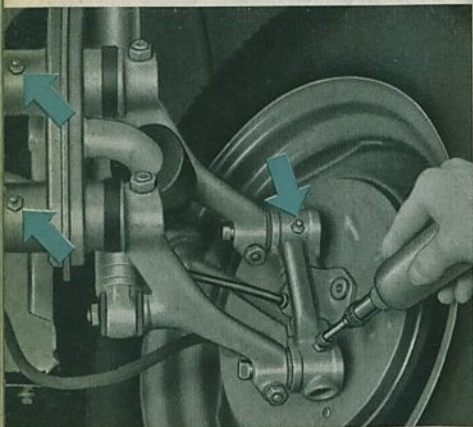

piece of cloth, so as to avoid any dirt or foreign matter entering the fittings. The tip of the grease gun should be pressed onto the fitting, whereupon grease should be injected until the excess grease begins to emerge at the edges of the lubrication point.

Not even the smallest quantity of grease must come into contact with the tires and brake hoses. If necessary, these parts have to be cleaned thoroughly.

If the car is driven mainly over rough roads, we recommend you to lubricate torsion arm links and outer tie rod ends at more frequent intervals, say every 1,250 km. (800 miles).

Annually, at the beginning of the cold season, the cables and conduits of clutch, accelerator and heating should be cleaned and greased.

If necessary, lubricate the clutch cable adjusting nut in the clutch lever ball socket at the transmission.

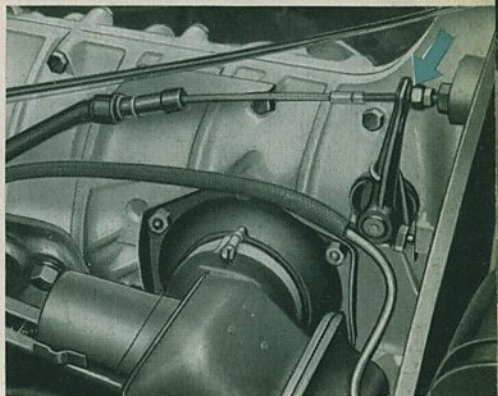

The Front Wheel Bearings

are sufficiently provided with grease at the factory. The caps on the front wheel hubs must be free from grease.

According to the lubrication chart the front wheel bearings are to be cleaned and repacked with grease as specified in the lubrication chart every 15,000 miles (25,000 km.). The brake drums must be removed for this purpose. Finally the front wheel bearings must be adjusted. In order to avoid damage to the bearings this operation should, if possible, be carried out at a VW Workshop.

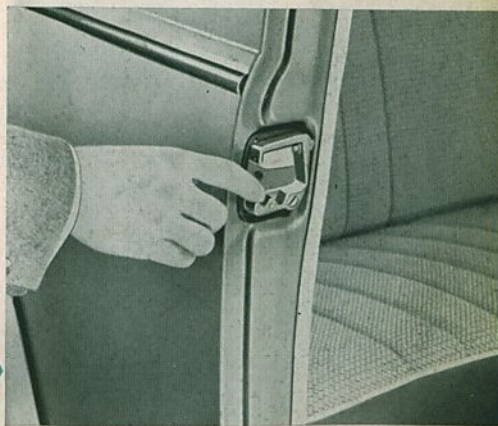

Doors

The door lock striker plates should be very lightly greased. Apply a few drops

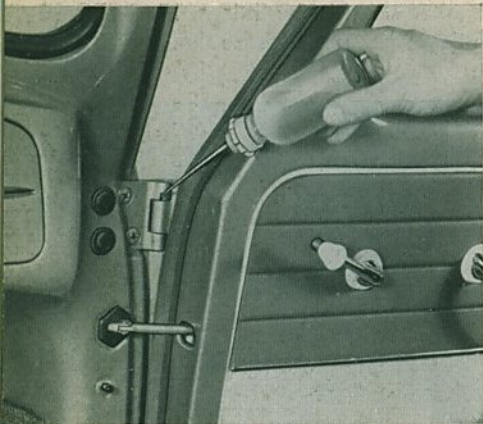

of oil to the hood hinges. The door hinges should be oiled at every lubrication service or, better, once a week after dust and dirt have been removed.

Door cylinder locks should be treated with graphite only. Blow a small quantity of powdered graphite through the key hole. Dip the key into the graphite, insert key and move it back and forth several times.

Window Regulators

The window regulator is accessible after the regulator handle, inside door handle and trim panel have been taken off. Press down the escutcheon plate, push out the pin and take off the handle. The trim panel is held by snap fasteners. Gear and joints of the window regulators (on the Convertible, the rear quarter window winder, too) should be greased, if found necessary after a longer period of service.

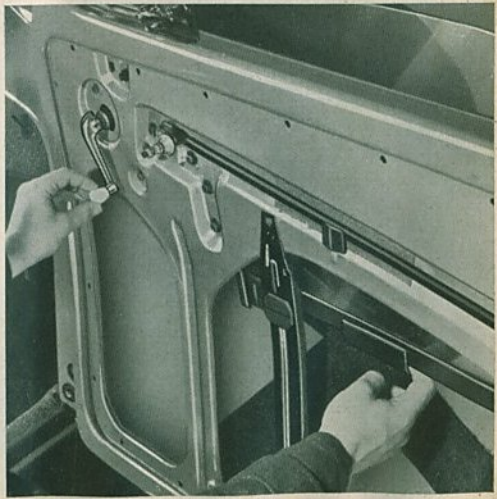
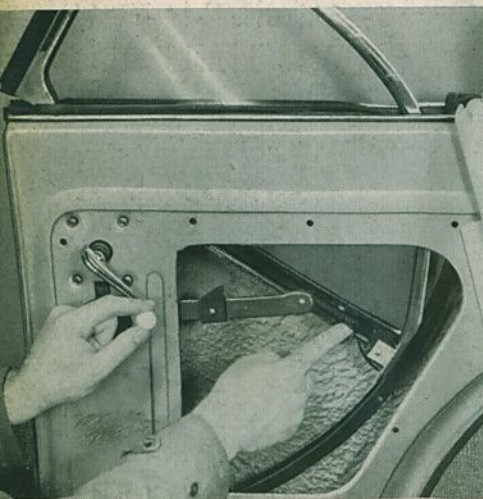

Front Seats

On the De Luxe and Convertible, the upper and lower sliding surface of the seat runners should be provided with grease. Only a small amount of grease is required to assure easy movement of the seats. Prior to lubrication, wipe over the runners with a rag. To remove, slide the seat fully toward the front. When installing the seat, hook the spring in position.



Gear Lever

Should the gear lever require lubrication, this can be done with the lever removed. Remove the two screws that attach the lever dome to the frame tunnel and lift off lever, dome and spring as a unit.

The contact surfaces in lever dome, at stop plate and lever ball socket should be amply provided with universal grease. When installing stop plate, make sure that the turned-up edge is on the right-hand side.

After installation, make sure the gears engage properly. If necessary, correct position of gear lever.

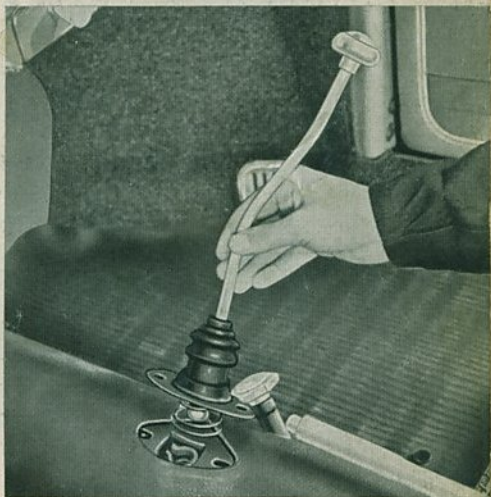

Convertible Top

The joints of the top linkages are lubricated by applying a few drops of oil after dust and dirt are removed. Care should be taken to avoid oil getting on to the top cover, as oil has a detrimental effect on the rubber seal.

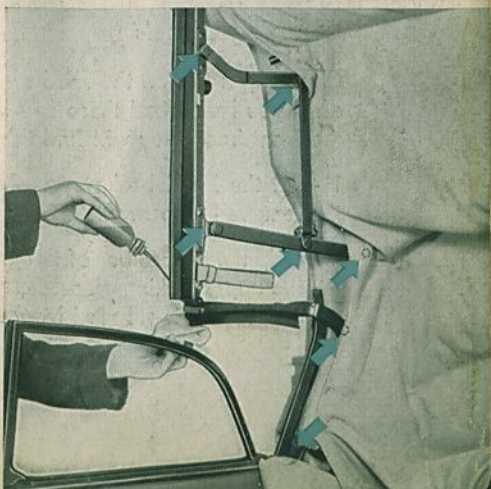

WHEELS AND TIRES

Under-inflation or over-inflation are the most common causes for tire failures. High speed driving and cornering, skidding to a stop and striking curbs or objects on the road wear tires more than many miles of careful driving.

Avoid overloading the car and protect the tires from intense sunlight, fuel, or oil.

Normal wear may be kept at a minimum by interchanging wheels and tires including the spare at approximately 5,000 km. (3,000 miles) intervals. Rotate wheels as shown in the illustration. This is a very good time to check the tires for foreign matter and outer damage. A drop of oil applied to the wheel mounting bolts facilitates the next wheel change.

To obtain a smooth high speed operation and a long tire life, it is important to have the wheels balanced statically and dynamically when tubes and tires have been repaired. As after longer running periods the wheels can be out of balance owing to natural wear of the tires, they should be balanced statically and dynamically every 6,000 miles. When the tires are being mounted, the red mark on the sidewall should be lined up with the valve to insure better balancing of tube and tire.

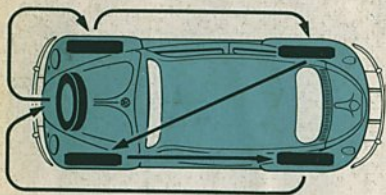

Changing Wheels

Changing a tire on the road certainly is not pleasant. However, it will be easier after you have read these few lines which tell you the correct way. Underneath the front hood, you will find the spare wheel, jack and tool kit.

- 1 - Set the hand brake securely and block the wheel opposite the one being removed to prevent the car shifting off the jack.
- 2 - Grip the square bar of the jack so that the thumb comes to rest on the nose of the upper locking piece. Exert pressure on the nose and slide down the square bar until it is stopped by the base plate.

- 3 - Insert the jack into the square tube below the body sill panel in front of the rear fender and push down the jack base plate until it makes contact with the ground.
- 4 - Remove hub cap by means of a screwdriver.
- 5 - Loosen wheel bolts by means of the socket wrench before wheel is fully jacked up.
- 6 - Raise jack until tire clears ground.
- 7 - Remove wheel bolts and take off the wheel.
- 8 - To install the spare wheel, operate the jack until the five holes in the wheel are nearly lined up with the holes in the brake drum.
- 9 - First, insert one wheel bolt only. Tighten it to such a degree as to allow the wheel to be swung around this point by hand until the remaining holes in the wheel and brake drum coincide.
- 10 - Insert the remaining bolts until the countersunk heads are centered in the corresponding recesses of the disc-wheel.
- 11 - Tighten all bolts diametrically opposite in turn.
- 12 - Insert one end of the jack operating rod into the hole marked "ab" and apply a light pressure on the opposite end of the rod to lower the car to the ground. Keep on exerting a pressure on the operating rod to allow the base plate to be pushed up, and remove the jack.
- 13 - Make sure that all bolts are tight.
- 14 - Install hub cap firmly and make sure that it is tightly seated.

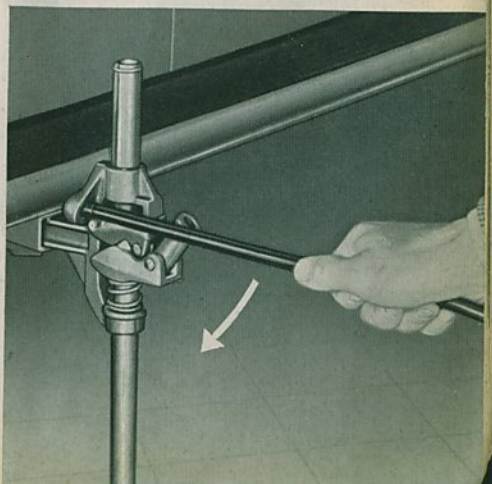
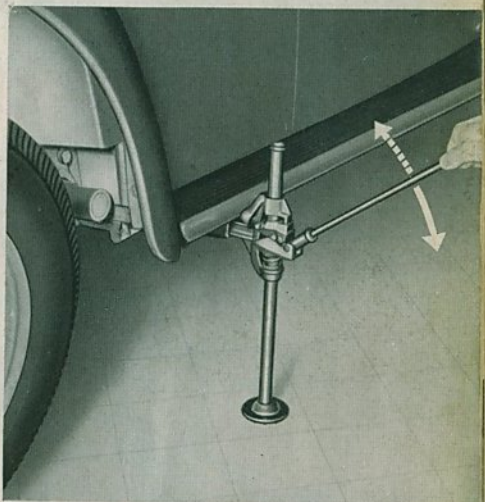

CARE OF THE CAR

Clean and Neat Appearance

To keep the VOLKSWAGEN looking smart and new should be a matter of pride to the driver or owner of the car. We made it the object of our efforts to use a lasting paint finish of sparkling lustre. A chemical treatment protects the body against rust and corrosion and anchors the paint securely to the metal. The finish is of high-quality synthetic resin (enamel) and carefully blended to obtain the most beautiful shades.

You will realize the importance of the paint finish if you consider that it is exposed to the elements; it has to resist sunshine, rain, dust and dirt. That is why periodic care of the body is necessary to retard any disintegrating process.

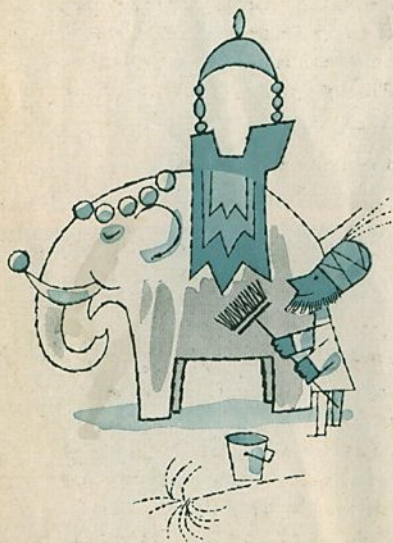

Washing Your Car

Wash your new car frequently during the first weeks. This practice will be of great advantage to the finish. For washing your car you require a soft sponge for the body, a soft brush for the wheels, a sturdy, long-handled brush for the chassis, and plenty of clear water! For drying the car you need a chamois.

The chassis and lower part of the body should first be flushed with water, to soak off the dirt, and afterward a brush should be used.



Apply an even spray of water on the exterior finish of body and wheels until dirt is soaked off. Do not allow a powerful jet of water to hit the varnished surface. Use plenty of clear water, remove dirt with a sponge. Care should be taken to clean the sponge at short intervals so as to avoid scratches on polished parts.

There are some approved auto soaps and detergents which greatly facilitate this job. Avoid the use of any product which has not been recommended by your VW Dealer. It is of utmost importance to rinse the body thoroughly with water after the car-wash has been applied to insure that no traces of it remain on the body.

After washing, rub down with a clean chamois to prevent water spots.

Preservation (Waxing)

means to restore to the finish certain substances it has lost by exposure to the weather. As these substances are vitally important to the elasticity of the finish, it is necessary to apply a protective water-repellent coat of wax to the body. The intensive cleaning effect of the shampoo removes this protective coating so that it should be renewed accordingly. A preservative specially produced for the finish of your VOLKSWAGEN can be obtained under the designation "L 190" from your VW Dealer. The body should be waxed after the first eight or ten weeks

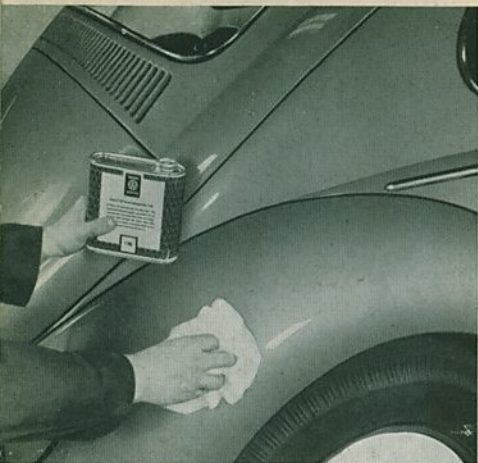

and then regularly at intervals of from six to eight weeks — in any case after each soap or detergent washing, as already mentioned. Applying the preservative is quite easy: With a soft cloth, spread a thin film on the finish, then rub it down when dry (after about 20 minutes), using polishing cotton or a soft polishing cloth, until iridescent colors can no longer be seen when you are standing at an angle to the polished area.

Of course, the car must be washed and dried carefully prior to applying the preservative.

Polishing

You should polish your car only if its appearance has been strongly affected by road dust, sunlight and rain as a consequence of insufficient care, or if the application of the preservative no longer restores the original lustre. Avoid the use of abrasives or chemically harmful products, even if their first application seems to give satisfactory results. A special polish for treating the synthetic-resin (enamel) finish is also obtainable from your VOLKSWAGEN Dealer under the designation "L 170".

Prior to applying the polish, the car must be washed and dried carefully. Dust or soil should never be wiped off dry. The polish should be applied with a soft and clean cloth or polishing cotton — use a straight horizontal or vertical motion rather than a circular motion. After some time of rubbing you will feel a slight resistance, which indicates that the ingredients of the polish have settled in the finish and that the solvent has evaporated. Now take clean polishing cotton and rub the body down until the high polish is restored. Do not apply the polish on too large an area of the body at a time.

A subsequent application of the preservative gives you care-free pride in your car for a long time.

Never wash or polish the car in sunlight or when the metal is warm.

How to Remove Spots

By a mere washing you cannot always remove splashes of tar, oil traces, "baked on" insects, etc. As a matter of principle, such foreign matter should be removed as soon as possible, for if you neglect this rule, permanent damage may result to the finish.

Tar Spots

An unpleasant sight, to be noticed particularly on light-colored cars, are tiny tar spots which show up on the fenders on hot days when driving on newly tarred roads. Tar splashes have a tendency to corrode the finish within a short time and should be removed immediately when discovered. On the move, you usually have nothing at your disposal but fuel, which may be applied with a soft cloth. Kerosene or turpentine oil may also be used. After this, the treated spots should be washed with a mild, lukewarm soap-solution, and rinsed, in order to remove traces of the cleansing agent. It is, however, better to use our preservative already mentioned, which renders the treatment with soap-solution unnecessary.

Insects

are caught especially during the night, in hot weather, by fenders, headlights, and front hood. Once baked on they can hardly be removed with water and sponge, but should be treated with lukewarm soap-solution.

Blooming Trees

and more especially lime-trees, in many instances drop tiny quantities of liquids. Cars that have been parked underneath such trees become "freckled" all over. These stains, too, can be readily removed with soap-solution.

A treatment of the cleaned spots with the preservative is strongly recommended.

Cleaning Sun Roof

The plastic cover of the sun roof does not call for special care. It can be kept in good condition by cleaning it at long intervals with mild soap suds or shampoo and rinsing thoroughly with clear water. Never attempt to remove spots with kerosene, mineral spirits, alcohol, or acetone, as these will attack the plastic cover.

Care of the Convertible Top

The appearance and life of the top greatly depends on a proper care and maintenance.

The top must always be perfectly dry before lowering it. When having driven the car on dusty roads, slightly beat out the top and brush the fabric in line with the

lay of the thread by means of a soft brush, as the sharp foreign particles harm the top fabric if not removed soon.

Damage due to friction may occur when the lowered top is not tightly held in position by the catches which engage in the slots cut in the side rails. In such cases, the catches should be screwed further into their retainers. To do this, the lock nuts are to be loosened before and tightened after the adjustment.

Spots can be removed from the material with an "art" gum eraser and brushed off with a whisk broom. Never use fuel or another volatile cleaner, as they destroy the rubber ply in the top cover, leading to leaks and shortening the life of the top.

The top should be washed only when it is exceptionally dirty. Only use clear water which is free from chemical products or other additives. Prior to washing, beat out the top and then brush it off. Use lukewarm water and a mild soap, only such soap as castile or olive oil base soaps should be used. Moisten the top with clear water and apply the thick suds. Scrub the top with a soft brush. After scrubbing, flush off the suds with clear water. If necessary, repeat the scrubbing with suds. There should be no traces of the suds when the top has been flushed. Be sure the top is thoroughly dry before lowering.

After washing the top, clean the finish of the car by flushing with clear water and rubbing dry with a clean, soft cloth.

Chrome-Plated Parts

should be lightly coated with chromium wax. The use of grease or vaseline is not recommended as these will bind dust and dirt.

Care of the Cloth Upholstery

If no vacuum cleaner is available, the upholstery should be cleaned thoroughly with a brush or whisk broom. Grease and oil stains on the upholstery or interior trim cloth are removed with cleaning fluid. Do not pour the cleaning fluid directly on the spot to avoid forming a ring. Moisten a clean, not colored, cloth with the fluid and rub with a circular motion, starting outside the spot and working inwards to the center.

Other stains can generally be removed with lukewarm soap-suds.

Care of Imitation Leather Upholstery

It is recommended to clean the artificial leather upholstery with a soft cloth or a soft brush. Special care should be taken to remove dust and dirt also from the upholstery seams. A better cleaning effect is obtained by the use of soft whisk

broom and suds of lukewarm water (rain water, boiled or soft water) and any mild soap (castile or olive oil base soaps). Use the water sparingly, as the upholstery otherwise requires a long time to dry, if water trickles through the seam stitches. Grease and paint spots should be wiped off before they dry up. Soaked-in spots can be removed by carefully using a rag moistened with gasoline or alcohol. Spots caused by shoe polish can be removed by means of turpentine. Use these agents carefully and sparingly as, otherwise, they would tend to dissolve the dust-rejecting finish of the artificial leather. Solvents such as trichloroethylene or thinner may not be used for cleaning. After completing the cleaning operation, use a clean, soft cloth to polish the surface of the leather. Carefully treat the upholstery seams. Never use furniture polishes, oils, varnishes or cleaners on imitation leather upholsteries. They will injure the finish.

Care of Leather Upholstery

The leather upholstery should be serviced in accordance with the instructions given for the imitation leather upholstery. After the upholstery has been wiped dry, a suitable cleaner may be used to clean, preserve and brighten the appearance.

Cleaning Glass

Windows can be cleaned by washing with water and wiping dry with a clean, soft linen cloth or chamois. In order to facilitate this task on the windshield, the arms of the windshield wipers may be tilted forward. To clean unusually dirty windows, use alcohol or household ammonia and lukewarm water.

Door and Window Weather Strips

To assure a perfect door and window seal on the Convertible, it is important to keep the rubber parts undamaged and supple. To retain the original flexibility and to reduce friction, it is recommended to apply a light coating of talc powder to all rubber parts after each car wash. Frictional noises between the side window frames and the rubber strips on the Convertible can be easily eliminated by using a mixture of glycerin and talc.

Airing the Interior

If the car is left stationary for a longer period in your garage, attention should be paid to the airing conditions. Permit air to circulate freely through the body by opening the doors and lowering the windows to prevent a forming of mould and damp-stains.

MAINTENANCE

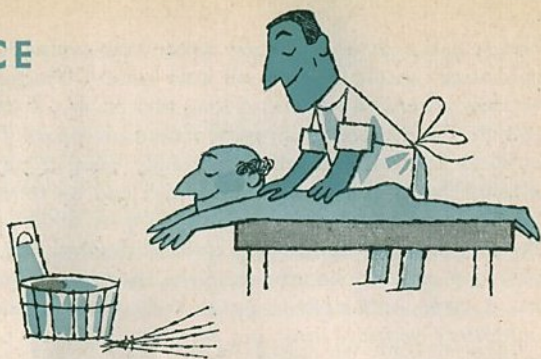

The VOLKSWAGEN SERVICE ORGANIZATION has made available for you an extensive network of Authorized VW Workshops staffed with well trained and experienced men, and equipped with all the special tools and appliances required to service your car. If ever you should need service when touring and away from home, look for the well-known VW Service Sign. The workshop displaying this sign is your assurance of the same expert, prompt, and courteous service you are accustomed to receive at home.

For the event that you can't get to an Authorized VW Workshop in time, we are giving you some information which, if needed, will help you to carry out normal maintenance work. However, repair jobs which are beyond your capacity should by all means be performed by the nearest VW Workshop. There your car will be given expert treatment by those familiar with its construction.

This will save you time, inconvenience, and money.



1-Filter element, 2-Gasket, 3-Oil reservoir

Servicing Air Cleaner

The air cleaner filters particles of dirt and grit from the air used for combustion. Regular servicing is especially important in dusty areas. A dirty air cleaner will cause frictional wear, decreasing operating efficiency and increasing fuel consumption. It should, therefore, be cleaned every 5,000 km. (3,000 miles).

To service air cleaner, remove it from the engine and take off the cover that houses the filter element after having detached the strap clamp. Remove dirty oil from reservoir and refill to indicated level with SAE 20 engine oil. Rinse the filter element in kerosene or any other degreasing fluid and allow the fluid to drain from

the filter. As a general rule, the cleaner oil level should be checked in conjunction with the engine oil level (every 2,500 km. / 1,500 miles). When adding oil, be sure the level in the fluid reservoir does not rise above the mark.

If the car is mainly operating under desert or other extreme conditions of dust-laden atmosphere, it is up to you to prevent premature wear by servicing the air cleaner more frequently than specified above.

Air cleaner service is overdue if there is no thin oil above the sludge and dirt that has accumulated in the fluid reservoir.

Adjusting and Replacing the Fan Belt

To adjust and replace the fan belt, remove nut and outer half of generator pulley. When loosening or tightening nut, insert a screwdriver in the slot cut into the inner half of the pulley, and support it against upper generator housing bolt.

The adjustment of the fan belt tension is effected by means of spacer washers

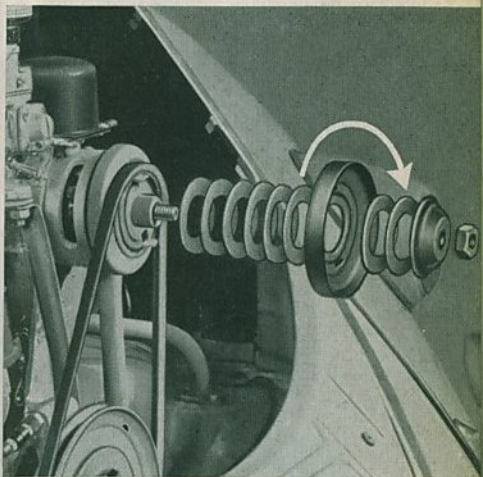
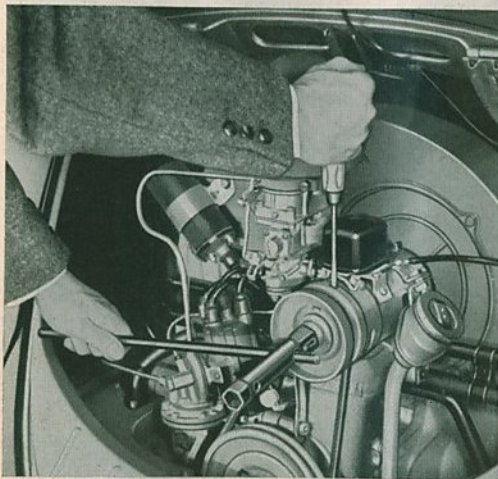

situated between the two pulley halves. Belt slackness is taken up by removing one or more washers. If the belt has too much tension, one or more washers should be added.

The fan belt should not be too slack, nor should it be too tight. Newly installed belts will stretch to some extent and should, therefore, be checked and adjusted after 50 or 100 kilometers (30 or 60 miles) of running.

Whenever the spare belt supplied with the accessories is used to replace the original V-belt, be sure to buy a new spare belt at once.

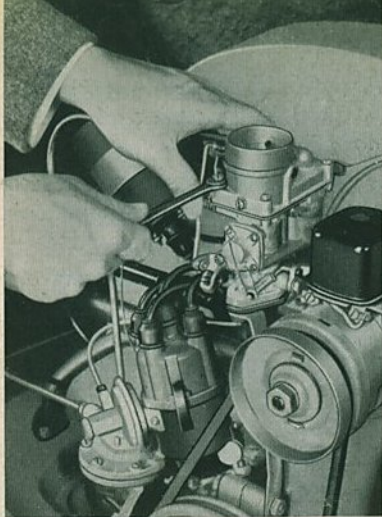

Cleaning the Carburetor

To clean the carburetor, it is sufficient to tilt back the bowl cover.

Bowl cover removal

- 1 - Remove the air cleaner.
- 2 - Disconnect the fuel line at the carburetor.
- 3 - Remove the four screws that attach the cover to the carburetor bowl.
- 4 - Lift the carburetor bowl cover and tilt it back.

If it is intended to remove the bowl cover completely, disconnect the choke control cable and the throttle connector rod.

To re-assemble the unit, proceed in reverse order. Install a new gasket and be sure of its proper position between bowl and bowl cover. Also make sure that the pump pipe fitting projecting over the bowl jointing face fits properly in the bowl cover.

Cleaning

- 1 - Remove float (3).
- 2 - Remove the main jet plug (4) and clean main jet and float bowl.
- 3 - Clean pilot jet air bleed (2).
- 4 - Clean pilot jet (15).
- 5 - Clean air correction jet (8) and emulsion tube (10).
- 6 - Clean float needle valve (14).
- 7 - Clean accelerator pump discharge passage.
- 8 - Clean passage from float bowl to accelerator pump.

Blow out the jets and passages with compressed air. Never use a pin or a piece of wire, as such practice will lead to damage.

Adjustment

The carburetor is tested at the factory and properly adjusted to the engine. Do not alter this adjustment by exchanging the jets or the venturi for other than the prescribed sizes. This would be detrimental under normal operating conditions and may result in hard starting, excessive fuel consumption or unsatisfactory engine performance. Only the idling of the engine may call for a readjustment occasionally.

- 1 - Choke
- 2 - Pilot jet air bleed
- 3 - Float
- 4 - Main jet
- 5 - Volume control screw
- 6 - Poppet valve
- 7 - Gasket
- 8 - Air correction jet
- 9 - Pump pipe fitting
- 10 - Emulsion tube
- 11 - Idling adjusting screw
- 12 - Accelerator pump
- 13 - Throttle
- 14 - Float needle valve
- 15 - Pilot jet
- 16 - Vacuum tube connection

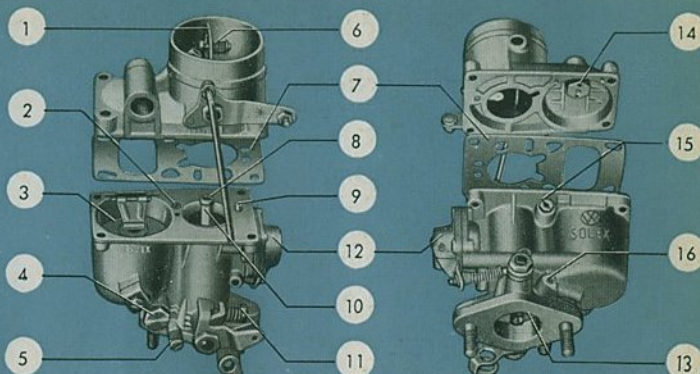

Before attempting to adjust the carburetor, make sure the engine is at normal operating temperature.

- 1 - Turn the idling adjusting screw (11) in or out until an idling speed of about 550 r.p.m. has been attained.
- 2 - Turn the volume control screw (5) clockwise until the engine speed begins to drop, then give it a quarter turn in anticlockwise direction. Then, if necessary, adjust a little in either direction until the engine idles smoothly.
- 3 - Re-adjust the idling adjusting screw until the engine runs at normal idling speed.

The adjustment is perfect if the engine does not stall after the throttle either is suddenly opened or suddenly shut with the clutch pedal depressed. Poor idling may also be the result of damaged gaskets, intake manifold flanges not sufficiently tightened, faulty ignition or leaky valves. Skill and experience are required to

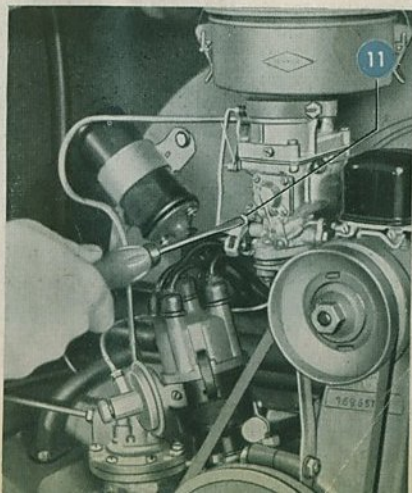
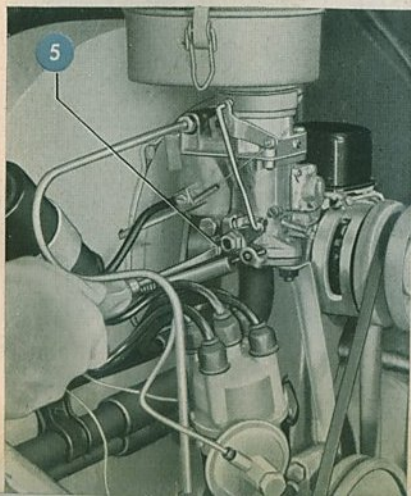

check and adjust the carburetor and the accelerator pump. For this reason you should leave this job to an Authorized VW Workshop.

Valve Adjustment

Proper adjustment of the valve clearance is important to prevent burning of valves and poor engine performance.

The following procedure should be carried out only in such emergencies where it is impossible for you to reach a VW Workshop.

Remove valve rocker cover.

Valve clearance should be 0.10 mm. (.004") with the engine cold. The valve clearance increases when the engine warms up. For this reason,

only adjust valve clearance when the engine is cold.

The arrangement of the cylinders can be seen by the numbers 1 to 4 indented in the cover plates.

Valve adjustment may be made in the following sequence: 1st — 2nd — 3rd — 4th cylinder.

Adjust the valves when the piston of the corresponding cylinders is in top dead center position of the compression stroke. Starting with the 1st cylinder, crank the engine over slowly to the left by the fan pulley, until both valves are in fully closed position and the timing mark on the pulley is in line with the vertical jointing faces of the crankcase.

If the clearance requires adjustment, loosen the lock nut of the adjusting screw and turn the adjusting screw as required to obtain the proper clearance. Tighten the lock nut and recheck the clearance. Readjust if necessary. Check and adjust the other valves to the proper clearance in this manner by turning the crankshaft anticlockwise another 180° for each cylinder.

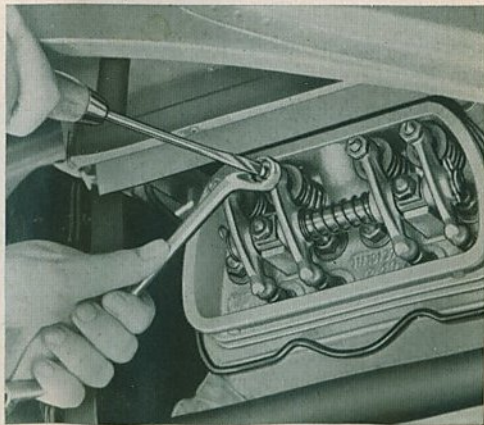
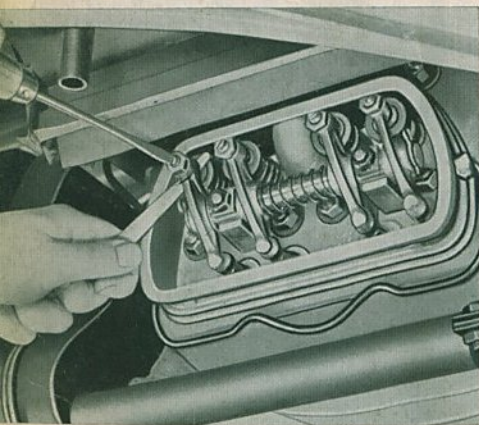

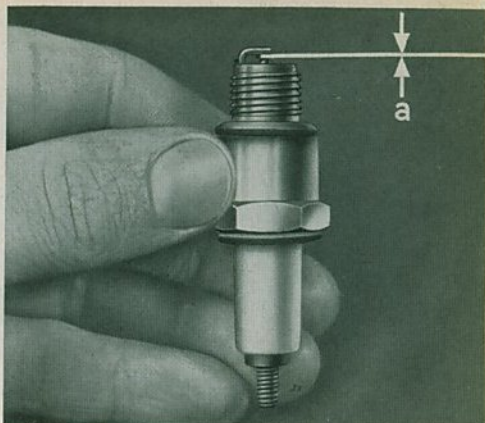
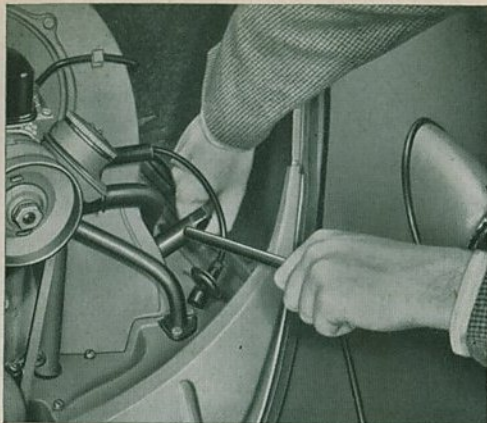

$a = 0.6-0.7 \text{ mm. } (.024-.028\text{'})$

Checking the Spark Plugs

The spark plugs must be thoroughly maintained for easy starting and economical operation. Remove the plugs and inspect their exterior.

Electrodes and insulator

- medium grey — good adjustment of carburetor and correct performance of spark plug,
- black — mixture too rich,
- light grey — mixture too lean,
- oiled up — failure of spark plug or worn-out cylinder.

Clean the spark plugs with a brush and a chip of wood and blow them out. Inspect the spark plug for cracked insulator and burned or pitted electrodes. The insulator should be clean and dry on the outside as well to avoid short circuits.

Check the electrode gap ($0.6-0.7 \text{ mm.} = .024-.028\text{'}$) and reset if necessary by bending the outer electrode. Look for a proper gasket before installing the plug. Generally speaking, you may count on a spark plug service life of up to 15,000 km. (9,300 miles).

Ignition and Timing

Particular attention should be attached to the importance of correct ignition timing. The operation of the engine will be seriously affected if the ignition breaker points are not properly timed and correctly spaced. In many cases poor performance, high fuel consumption and even severe damage to the engine can be the result of an incorrect ignition setting. The moment of ignition may not be advanced arbitrarily, not even when using premium grade fuels.

Adjustment may only be carried out **with the engine cold**.

Adjusting Contact Points

Remove distributor cap and rotor. The breaker contact points are adjusted by cranking the engine until the fiber block on the contact arm rests on the highest point of the cam lobe. Then loosen the stationary point locking screw and turn the eccentric adjusting screw until the correct gap is obtained. Use a feeler gauge of the proper thickness (0.4 mm. = .016"). Tighten lock screw and recheck the gap. If the points are burned, rough or pitted, clean them with a contact file or, better yet, replace them. The distributor cap should be clean and dry to avoid short circuits.

After the contact points have been adjusted, it is absolutely necessary to check the ignition timing with the engine cold.

Ignition Timing

Crank the engine clockwise until the mark of the crankshaft pulley lines up with the vertical crankcase jointing faces and the distributor rotor arm is in the position for firing on the No. 1 cylinder (see mark on rim of distributor base). Loosen the lock screw below the distributor base and rotate the distributor body clockwise until the contact points are closed.

Now switch on the ignition and rotate the distributor slowly anti-clockwise until the contact points just start to open. This may be seen and heard, for a spark will jump from one point to the other.

To obtain a more accurate adjustment for maximum results, it is advisable to use a test lamp or an ignition timing light. The test lamp should be connected to the distributor primary lead terminal and to the ground. The lamp will light up as long as the contact points are kept open by one of the four cam

lobes of the distributor shaft. After the adjustment is completed, tighten the lock screw, replace the rotor and clamp the cap on the distributor. Check vacuum tube unions for tightness.

Battery Maintenance

Ready starting of the engine depends upon perfect condition of the battery. Therefore, inspect the battery regularly as prescribed in the Maintenance chart.

The battery cover can be easily removed after the strap fastener has been opened. The state of charge of the battery may be checked by means of a battery hydrometer. The specific gravity of the battery liquid will increase with the charging



of the battery. Tested with the hydrometer, the gravity can be read from the scale of a float.

Battery fully charged	1.285 = 32° Bé
Battery semi-charged	1.230 = 27° Bé
Battery fully discharged	1.142 = 18° Bé

In addition, a voltmeter test should be made to insure that the battery is in good operating condition and able to provide the necessary current. The voltage of each cell should not fall below 1.6 volts while the reading is being taken (10—15 seconds). Otherwise the cell is discharged or defective. Under no-load conditions each charged cell should read 2.0 volts.

Add distilled water to each cell to bring the level to approximately 5 mm. (.2") above the plates or above the deflector plate, if there is any. If there is an acid

level mark, the acid level has to be adjusted accordingly. Losses by evaporation may only be replenished by adding distilled water. Never add acid, unless it is known that acid has been spilled from the battery. Check specific gravity afterwards and compensate if necessary.

Check condition of the battery posts and the cable terminals. They must be clean and tight to prevent excessive electrical resistance. Use a stiff brush to remove corrosion from both posts and terminals. Coat the clean posts and terminals with light grease or vaseline to prevent corrosion. Make sure that the battery is properly grounded.

Exchanging Fuses

Fuse boxes are located as follows:

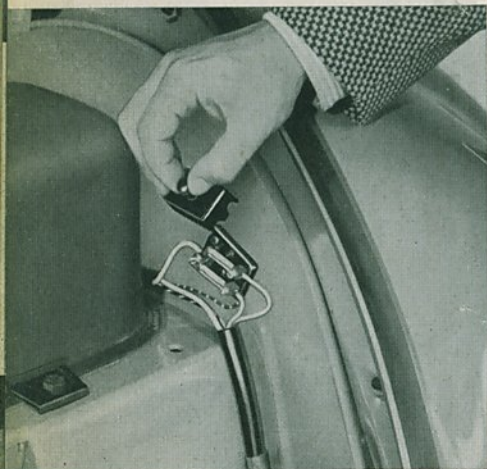

underneath the front hood, to the left of the fuel tank (2 poles).

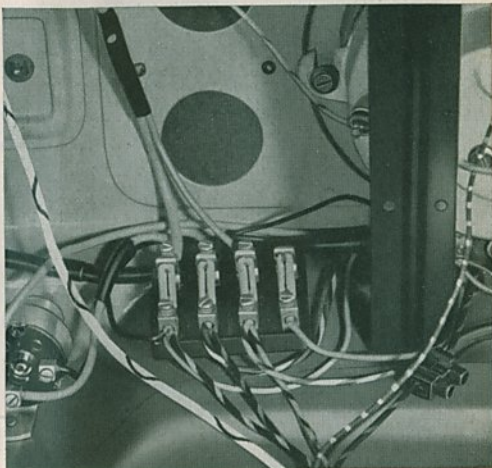

underneath the front hood on the back of the instrument panel (4 poles).

When a fuse has blown out, it is not sufficient merely to replace it by a new one. Inspect the electrical system for evidence of short circuits or other faults which may have caused the fuse to blow out.

In no event may fuses be used which have been patched up by means of tin foil or wire as they would be liable to cause severe damage. We suggest that you always carry along a few $\frac{8}{15}$ amperes spare fuses.

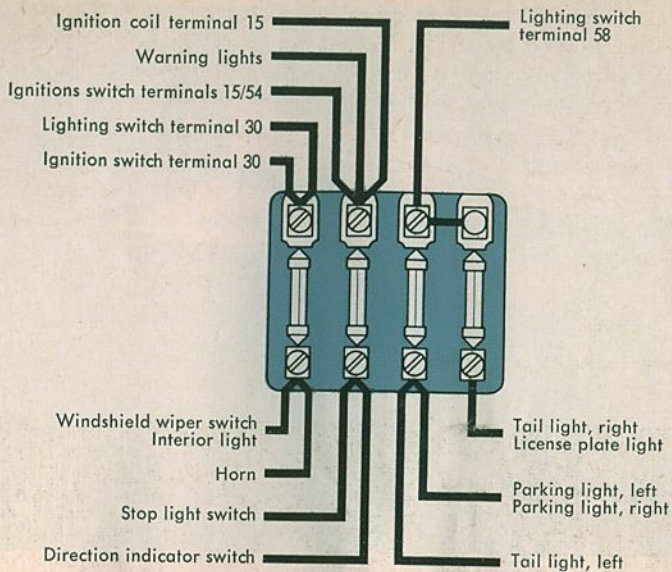

Fuse box on the back of the instrument panel

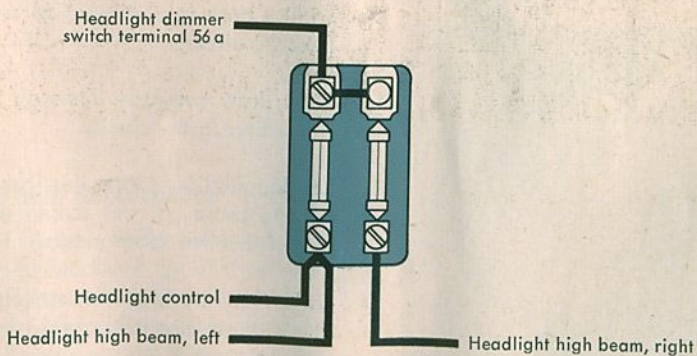

Fuse box adjacent to the fuel tank

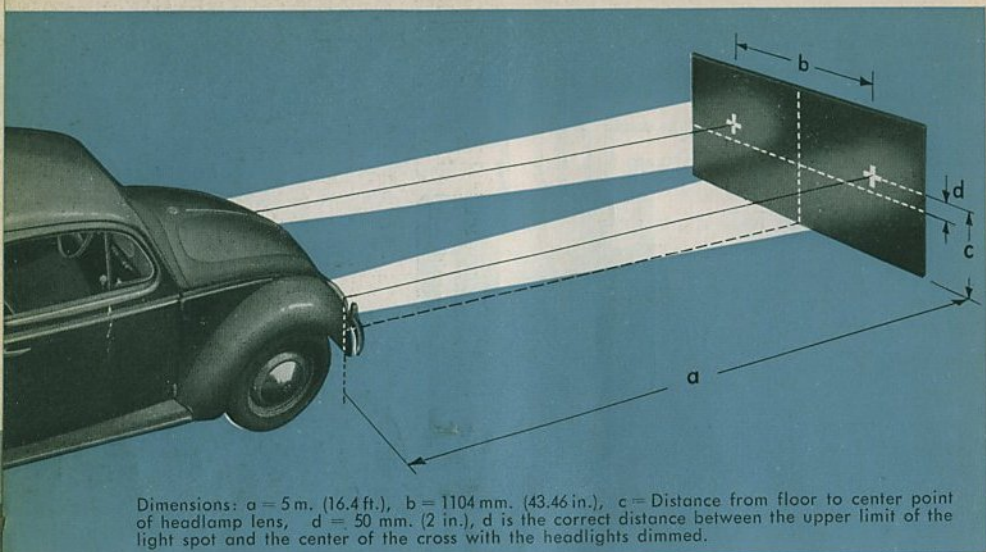

Aiming the Headlights

If no headlight aiming device is available, proceed as follows:



- 1 - Place the unloaded car in a level position with a dark-colored vertical screen 5 m. (16.4 ft.) ahead.
- 2 - Next draw two cross lines on the screen according to the sketch.
- 3 - The longitudinal center line (car axis) must hit the center of the screen exactly between the two cross marks.
- 4 - Switch on the high (country) beams and check the beams at the cross marks.
- 5 - Independent adjustment of both horizontal and vertical aim is provided with the adjustment screws accessible from the front of the headlight rim.



"Bosch" Headlights

Vertical Adjustment

Turn upper screw
to right — Beam swings down
to left — Beam swings up

Horizontal Adjustment

Turn right screw
to right — Beam swings to left
to left — Beam swings to right

"Hella" Headlights

Vertical Adjustment

Turn left screw
to right — Beam swings up
to left — Beam swings down

Horizontal Adjustment

Turn right screw
to right — Beam swings to right
to left — Beam swings to left



("Right" and "Left" is as indicated when sitting in the car facing forward.)

Then switch on the lower beam and check the distance between the upper limit of the light spot and the center of the cross (2").

Headlight Bulb Replacement

Loosen the slotted fixing screw at the bottom of the headlight rim. Pull out the lens and reflector unit, unhook the tension spring, and withdraw the lamp holder. When replacing the bulb, make sure the new bulb is clean and is not loose in the socket. When a broken lens is being replaced, the reflector should not be touched or wiped over.

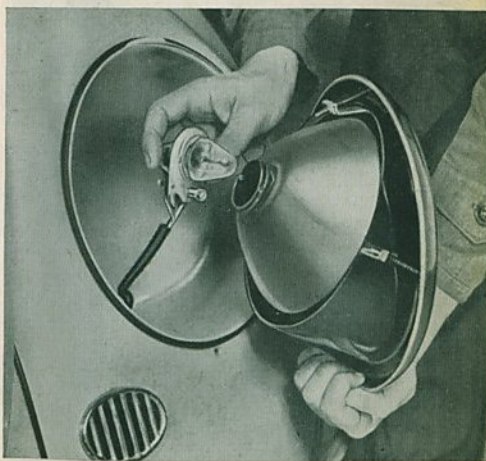



License Light Bulb Replacement

The license plate light is accessible after the rear hood has been partly lifted up. To replace the bulb, loosen the two fixing screws and pull out the lens.

Replace the bulb.



Stop and Tail Light Bulb Replacement

To replace the bulbs of the two combined stop and tail lights on the fenders, remove the slotted screw, lift the bezel away from the body, and pull out the bulb holder. When inserting the bulb holder, make sure the tongue at the bulb holder disc engages properly in the slot provided in the reflector.

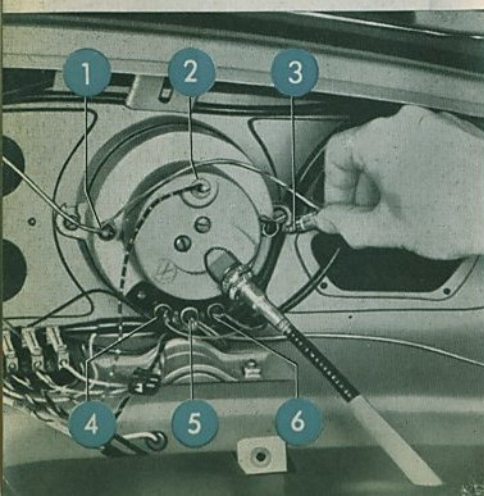

Warning and Instrument Light Bulb Replacement

The warning lights for oil pressure, charging, direction indicator and headlight main beam as well as the speedometer lights are accessible by lifting the front hood and removing the cover in front of the instrument panel. The bulb sockets can easily be pulled out from their holders.

1 and 3 - Speedometer lighting bulbs

Warning lamps:

2 - Headlights

4 - Oil pressure

5 - Direction indicators

6 - Generator

- 4 - Pump the brake pedal several times, forcing fluid through the lines until bubbles cease to appear in the container. Make sure that enough brake fluid remains in the fluid reservoir, since otherwise air will be sucked in.
- 5 - The brake pedal should be kept in the fully depressed condition until the bleeder valve is closed.
- 6 - Remove the bleeder hose and replace rubber cap.
- 7 - Repeat the above operations on the other wheels.
When the bleeding is completed, refill the master cylinder reservoir with brake fluid if necessary.

Adjusting Hydraulic Brake

Brakes require periodic adjustment to assure their proper operation. Too much free travel of the brake pedal is an indication that the clearance between brake shoes and brake drums has become too great and that the brakes need adjustment. This adjustment will usually compensate for such wear as will take place until relining of the shoes is required.

- 1 - Jack up all wheels clear of the floor. Turn the wheel to be adjusted forward, until the hole in the brake drum is in line with one of the adjusting nuts.
- 2 - Insert a screwdriver through the hole and turn the adjusting nut in the direction indicated by the arrow, using screwdriver as a lever, until a slight drag is noted when wheel is turned by hand.
- 3 - Repeat procedure on the other adjusting nut. Note the opposite turning direction of the two nuts.

front

rear

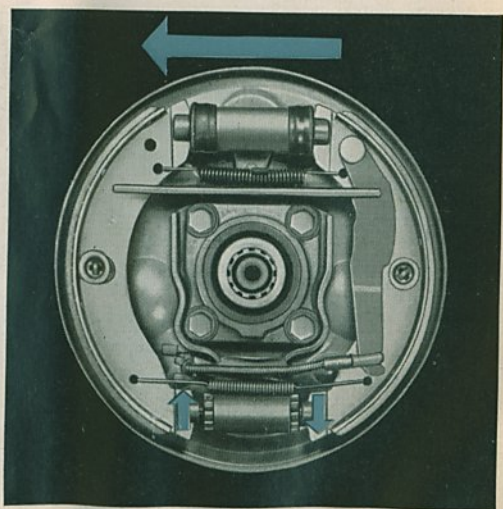
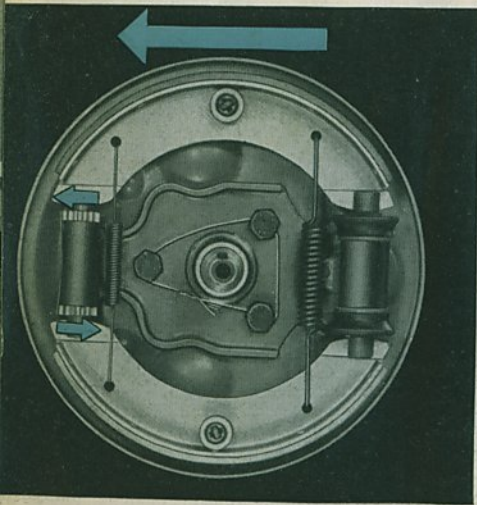

- 4 - Back off the adjusting nuts by 3 to 4 teeth until the wheel can be turned freely.
- 5 - Repeat the above operations on the other wheels.

Before and after brake adjustment it is advisable to depress the brake pedal sharply so that the brake shoes come into the proper position in the drum.

When adjusting the rear brakes, the hand brake must be released.

Adjusting Hand Brake

- 1 - Jack up both rear wheels.
- 2 - Fold back hand brake lever rubber boot.
- 3 - Tighten adjusting nuts on the front ends of the brake cables to a degree which will still allow the rear wheels to turn freely when the hand brake is released.
- 4 - Pull up hand brake lever by two notches and make sure both rear wheels have the same braking effect. At the fourth notch it should be impossible to turn the wheels by hand. Lock the adjusting nuts.

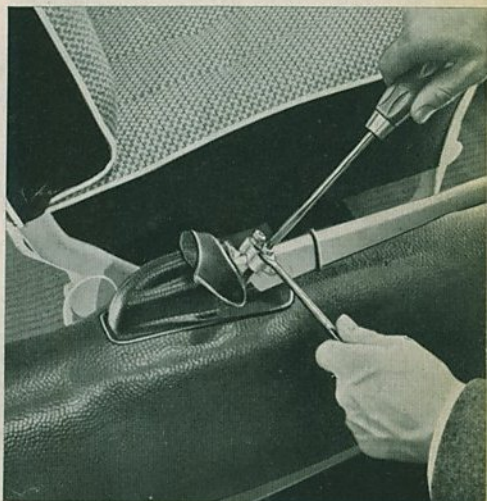

Adjusting Mechanical Brake

(Standard Model)

- 1 - Jack up all wheels clear of the floor and release the hand brake lever. Loosen the counternuts and brake cable adjusting nuts at the brake backing plate and turn both clockwise, that is, towards the brake backing plate.
- 2 - Tighten brake shoe adjusting nut until the brake drum can no longer be turned by hand.
- 3 - Turn back brake cable adjusting nut until there is very little clearance between brake cable and brake backing plate. Tighten counternut.

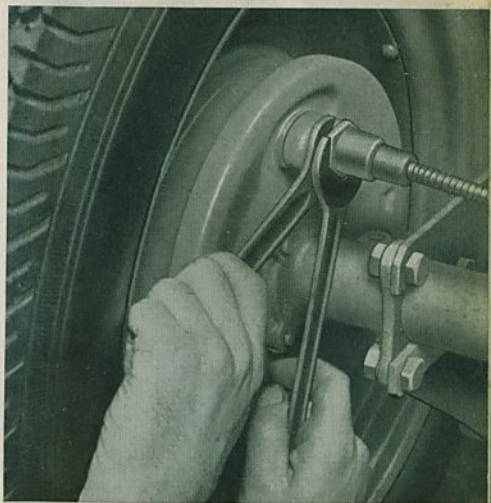

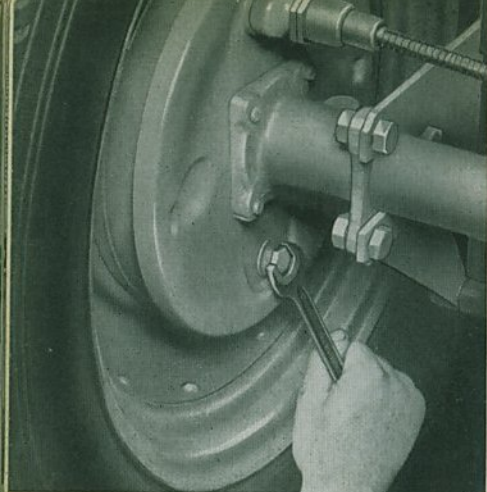

- 7 - In case there is a difference in the braking effect of the four wheels, release the hand brake and loosen the brake shoe adjusting nut on the wheel with the highest braking resistance. The brake cable adjusting nut, however, should not be disturbed. Likewise it would be wrong to tighten the adjusting nut on a wheel which shows a lesser braking resistance.
- 8 - Lower the car and make a road test to assure proper brake operation.

- 4 - Again loosen the brake shoe adjusting nut, until the brake drum can just be turned freely. A light tap against the nut will place the brake shoes and the adjusting cone in the right position.
- 5 - Repeat the above operations on the other wheels.
- 6 - Pull up the hand brake by two notches and check equal braking effect on all four wheels. Pull up hand brake by another notch and repeat check-up procedure. At the fourth notch it should be impossible to turn the wheels by hand.



Steering Gear

The need for adjustment will be evidenced by the development of excess free play in the steering wheel. The play should be as small as possible, but care must be taken to allow the front wheels to resume their straight-ahead position, after the car has taken a turn. As special experience is needed to service this unit properly, all operations or adjustments required should be performed only at an Authorized VW Workshop. If, however, a workshop is out of reach, proceed as follows:

- 1 - Turn the front wheels to the straight-ahead position.

- 2 - Loosen lock nut and sector shaft adjusting screw on top of the steering gear case.
- 3 - Adjust worm shaft end play: Loosen adjusting sleeve clamping screw and tighten adjusting sleeve clockwise until the worm shaft end play is taken up. Tighten adjusting sleeve clamping screw.
- 4 - Adjust sector shaft end play: Tighten adjusting screw clockwise as far as it will go and back it off $\frac{1}{8}$ turn.
- 5 - The adjusting nut is to be secured in position by the lock nut after the adjustment has been completed.
- 6 - After having completed adjustments with the car supported on trestles, check the steering for binding by turning the steering wheel in both directions as far as it will go.

The 3,000 miles maintenance service provides the regular adjustment of the torsion arm link pins on the front axle. After this operation it is absolutely necessary to check the toe-in of the front wheels.

Checking toe-in

With the vehicle empty and on the ground the toe-in should be 1—3 mm. (.040"—.118"). This adjustment of the front wheels can only be carried out satisfactorily in a workshop with the aid of a special gauge. If the wheels are not properly toed-in the result will be bad road holding and excessive tire wear.

Front Wheel Bearings

The front wheel bearings will occasionally require adjustment. We recommend you to refer this operation to an Authorized VW Workshop, as maladjustment may cause severe damage to the bearings.

If circumstances require a removal of a front brake drum, the front wheel bearings are to be adjusted as outlined below:

Tighten inner nut until the thrust washer can just be moved laterally by a screwdriver and no bearing play can be felt



when rocking the brake drum. Too loose or too tight an adjustment may ruin the bearings in a very short time.

Finally, secure the nuts by bending down the lock plate.

Convertible Door Windows

A vertical adjustment of the door windows on Convertibles is possible by stop screws, which are accessible by removing the door trim panels. The lock nut of the stop screw is to be loosened before an adjustment is made.

Adjustment of Door Lock

There is no need for regular adjustment of Volkswagen door locks. In the case of a rattling or jamming door the wedge can easily be adjusted.

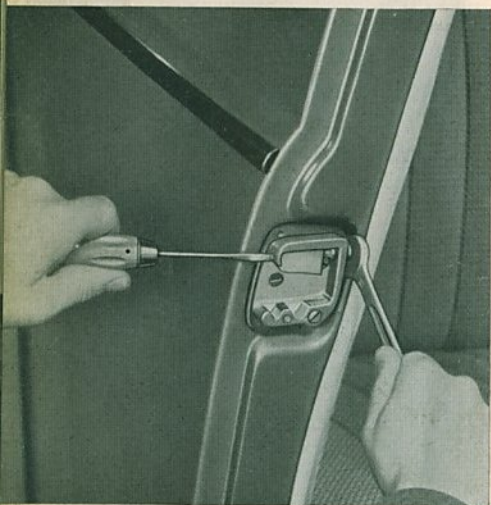

1 - Check the 3 striker plate screws for proper seating. Tighten if necessary. Adjust the striker plate so that door and pillars are a flush fit. The lock housing on the door must have about the same clearance at top and bottom when sliding into the striker plate.

2 - Hold the adjusting screw by means of a screwdriver and tighten lock nut with a 11 mm. ($7/16''$) wrench.

3 - Turn the adjusting screw to the left if the door is rattling and to the right if it jams. A quarter to half a turn will usually suffice to bring the shoulder for the wedge into the proper position.

- 4 - The locking device is properly adjusted if a resistance can be felt when opening the door with the inside handle. If, however, there is too much resistance or if the door jumps open on its own, turn the shoulder back slightly. This is done by turning the adjusting screw to the right.
- 5 - After adjustment, hold the screw with a screwdriver and tighten lock nut.



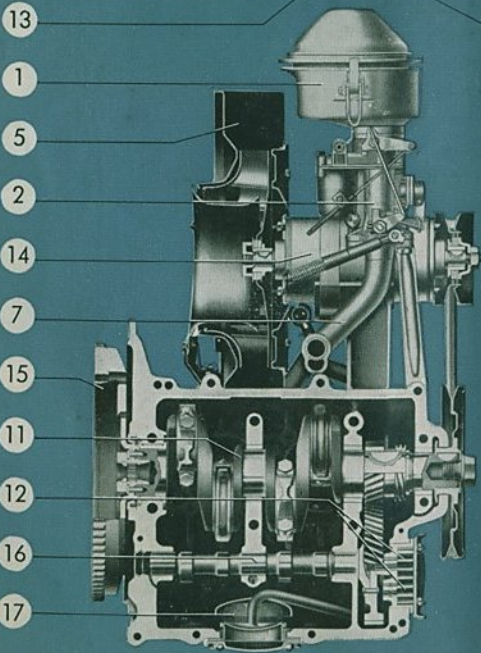
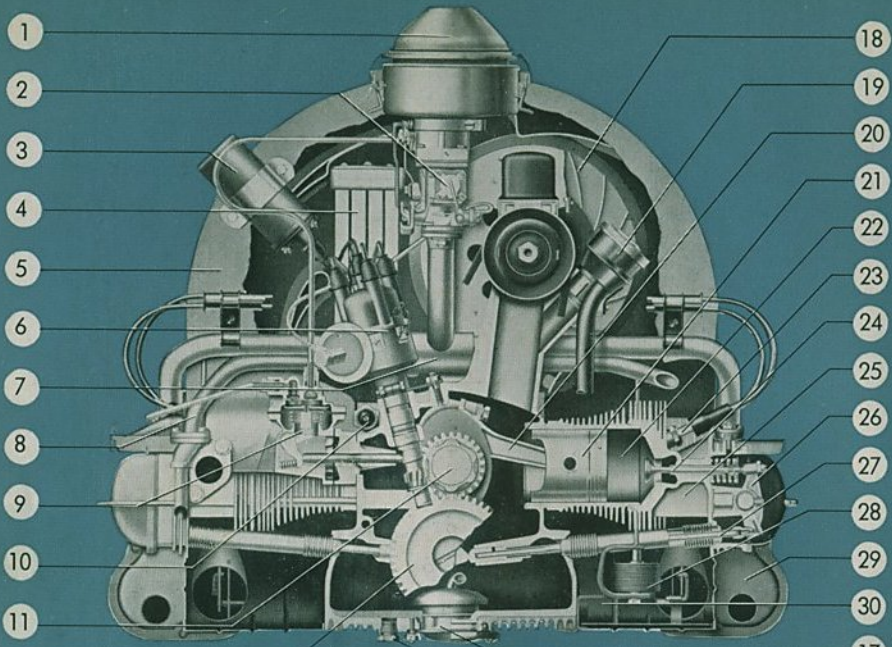

Engine

- 1 - Oilbath air cleaner
- 2 - Carburetor
- 3 - Ignition coil
- 4 - Oil cooler
- 5 - Fan housing
- 6 - Ignition distributor
- 7 - Pipe intake manifold
- 8 - Pre-heating pipe
- 9 - Fuel pump
- 10 - Oil pressure switch
- 11 - Crankshaft
- 12 - Camshaft
- 13 - Camshaft timing gear
- 14 - Generator
- 15 - Flywheel
- 16 - Oil pump
- 17 - Oil strainer
- 18 - Fan
- 19 - Oil filler and breather
- 20 - Connecting rod
- 21 - Piston
- 22 - Cylinder
- 23 - Spark plug
- 24 - Valve
- 25 - Cylinder head
- 26 - Rocker arm
- 27 - Valve push rod
- 28 - Thermostat
- 29 - Heater junction box
- 30 - Heating channel
- 31 - Oil drain plug

GENERAL DESCRIPTION

Engine

The engine, located in the rear of the car, is mounted in a floating fashion on the recessed flange of the rubber-cushioned transmission case. Two pairs of cylinders are horizontally opposed. Each pair has a common cylinder head made of light alloy. The overhead valves are located in the cylinder head and are operated by means of push rods and rocker arms. The short and counter-balanced crankshaft rests in four replaceable special light alloy bearings and is heat-treated at its four points of support. It drives the camshaft by means of helical gears. The connecting rods are fitted with interchangeable steel-backed lead-bronze bearings. The pistons are made of aluminum alloy.

A down-draft carburetor with accelerator pump produces the fuel-air mixture to supply the cylinders. The engine is equipped with battery ignition.

The spark advance is controlled automatically in two ways, by a centrifugal advance mechanism and a vacuum advance mechanism to assure proper functioning of the ignition under all operating conditions.

The oil pump of this full pressure lubrication system is driven by the camshaft and it sucks the oil from the crankcase through a strainer, from where it will reach the points of lubrication via an oil cooler. In cold weather, when the oil is of higher viscosity, an oil pressure relief valve makes it possible for the engine to be lubricated directly, that is, by avoiding the oil cooling system. The air cooling of the engine is done by means of a fan, which is attached to the extended generator shaft and driven from the crankshaft by an adjustable V-belt. The fan sucks in air through an opening in the fan housing, and the air cools the engine by passing through fins. A thermostat controls and regulates the amount of cooling air and insures well-balanced operating and heating temperatures.

Chassis

The frame of the VOLKSWAGEN is of pressed steel. The steel floor of the frame is formed in two pieces. These two pieces are spot-welded together with the channel-shaped center section of the frame, the forked rear end of which serves to support the transmission and engine unit. The following parts pass through the center of the frame:

Gearshift rod, hand brake linkage, fuel line, and, in conduits, the cables of brakes, clutch, throttle, choke, and warm-air heating unit.

The front suspension is an independent parallel arm type, using torsion bar springs. The front axle is bolted to the front end of the frame and consists of two rigidly joined tubes, which carry the torsion bar springs and the upper and lower

arms of the front wheel suspension. The rear axle is of the swinging half axle design. The rear wheels likewise are independently sprung, using one individual torsion bar spring on each side. Double-acting hydraulic shock absorbers in front and rear prevent excessive rebound.

Transmission and Rear Axle

Power from the engine is transmitted to the gears via a dry single-disc clutch. The transmission case incorporates four speeds forward, one reverse, and the differential.

The **De Luxe** and the **Convertible** are equipped with synchromesh devices for the 2nd, 3rd, and 4th gears. The gears are helically cut to provide silent operation.

With the Standard Model — without synchromesh — the gears of the 3rd and 4th speeds are in constant mesh and provide silent operation.

The drive pinion and the ring gear are cut spirally. The two swinging rear axle shafts are flexibly supported in the differential housing.

Brakes

The De Luxe and the Convertible are equipped with direct acting hydraulic brakes operating on all wheels. An additional hand-operated brake is provided for use when the car is parked. The hand brake operates the rear wheel brake shoes through cables. The Standard Model is equipped with mechanical brakes. The foot brake and the hand brake both operate on all wheels through mechanical linkage and cables that pass through conduits for greater protection against the weather.

Body

The basic structure of the VOLKSWAGEN is made of formed steel panels, electrically welded together and strongly reinforced to provide maximum rigidity. Draft-free ventilation by means of vent wings is provided on both door windows. Both front seats can easily be adjusted even when the car is in motion (De Luxe and Convertible). The front hood lock is released by pulling a knob. The fuel tank and the spare wheel are located underneath the front hood. Luggage space is provided behind the rear seats and under the front hood.

Heating System

Heated air, which is taken from the air flow warmed up by the engine, is emitted through two openings at foot level in the front of the car. For defrosting, two ducts direct heated air to nozzles at the windshield. The heating system can be controlled from the driver's seat by means of a rotary knob situated in front of the hand brake lever.

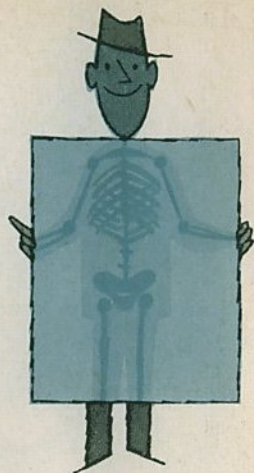

TECHNICAL DATA

Engine

Design	4 Cylinder, 4 Cycle, O.H.V.-Type, in rear of car	
Arrangement of Cylinders	Horizontally opposed (Flat Four)	
Bore	77 mm. (3.031")	
Stroke	64 mm. (2.520")	
Capacity	1192 c.c.	
Compression Ratio	6.6	
Valve Clearance	Intake 0.10 mm. (.004")	} to be adjusted when engine is cold
	Exhaust 0.10 mm. (.004")	
Brake Horsepower (SAE)	36 at 3700 R.P.M.	
Lubrication	Force Feed (Gear Pump) with Oil Cooler	
Oil Capacity	Metric — 2.5 liters U.S. — 5.3 pints Imp. — 4.4 pints	
Fuel Pump	Diaphragm Type	
Carburetor	Down-Draft Type, Solex 28 PCI	

Cooling System	Air Cooling by Fan, Thermostat-controlled Air Intake	
Battery	6 Volts, 66 Ampere Hours	
Starting Motor	Electric, 6 Volts, 0.5 HP.	
Generator	Voltage regulated, 6 Volts, 160 Watts at 2500 R.P.M.	
Ignition Distributor	Centrifugal and Vacuum Spark Advance	
Firing Order	1—4—3—2	
Initial Spark Advance	7.5° before T.D.C.	
Breaker Point Gap	0.4 mm. (.016")	
Spark Plugs	Bosch W 225 T 1 Beru K 225/14 and 2 AC 43 L Lodge H 14 or HN Champion L 10 S, or L 85 Auto-Lite AE 6 or AER 6 KLG F 70	} 14 mm.
Spark Plug Gap	0.6 to 0.7 mm. (.024 to .027")	

Clutch

Design	Single Disc, dry
Pedal Free Play	10 to 20 mm. ($\frac{25}{64}$ " — $\frac{25}{32}$ ")

Transmission

4 Speeds Forward, 1 Reverse

De Luxe and Convertible: 2nd, 3rd, and 4th Gears Synchronized and Helically Cut for Silent Operation.

Gear Ratios	First	3.60:1	Third	1.22:1
	Second	1.88:1	Fourth	0.82:1
			Reverse	4.63:1

Standard Model: 3rd and 4th gears helically cut for silent operation.

Gear Ratios	First	3.60:1	Third	1.25:1
	Second	2.07:1	Fourth	0.80:1
			Reverse	6.60:1

Rear Axle

Power is transmitted through a spiral drive pinion and ring gear, via two swinging axles to the rear wheels.

Ratio	4.43:1
Oil Capacity of Transmission and Rear Axle	Metric — 2.5 liters
	U.S. — 5.3 pints
	Imp. — 4.4 pints

Chassis

Springs, Front	Two Torsion Bars
Rear	Two Torsion Bars
Shock Absorbers	Double Acting Telescopic Type, Front and Rear
Steering	Worm Steering Gear, divided Tie Rod
Turns of Steering Wheel, Lock to Lock	2.4
Turning Circle	about 11 meters (36 ft.)
Wheels	Disc Wheels 4 J × 15, Drop-Center Type
Tires	5.60—15, tubeless
Inflation Pressure	
1 to 2 Occupants	Front: 1.1 at. Rear: 1.4 at. 16 lbs./sq. in. 20 lbs./sq. in.
3 to 5 Occupants	Front: 1.2 at. Rear: 1.6 at. 17 lbs./sq. in. 23 lbs./sq. in.
Wheel Base	2,400 mm. (5 ft. 10.5 in.)
Track (Tread)	Front: De Luxe Mod. 1,305 mm. (4ft. 3.3 in.) Stand. Mod. 1,290 mm. (4ft. 2.8 in.) Rear: 1,250 mm. (4 ft. 1.2 in.)
Toe-in (car unloaded)	1 to 3 mm. (0.04 in. to 0.1 in.)

Brakes

De Luxe and Convertible	Foot Brake Hydraulic Brake, Operating on All Wheels
	Hand Brake Mechanical, Operating on Rear Wheels
Standard Model	Foot and Hand Brake Mechanical, Operating on All Wheels

Dimensions and Weights

Length	4,070 mm. (13 ft. 4 in.)
Width	1,540 mm. (5 ft. 1/2 in.)
Height	1,500 mm. (4 ft. 11 in.)
Road Clearance	155 mm. (6.1 in.)

	Sedan	Convertible
Unladen Weight, Ready for Use	730 kg.	800 kg.
Max. Load	380 kg.	360 kg.
Permissible Total Weight	1,110 kg.	1,160 kg.
Max. Load on Front Axle	450 kg.	480 kg.
Max. Load on Rear Axle	660 kg.	680 kg.

Fuel Consumption

Standard Consumption according to DIN 70030	Metric — 7.3 liters per 100 km.
	U.S. — 32 miles per gallon
	Imp. — 38 miles per gallon

(Consumption plus 10% at half the Load and at a steady 3/4 of top speed on level road.)

Fuel	Octane Number 76 (Res. F 1)
Oil Consumption	0.3—1.0 liter per 1,000 km. (600 miles)

Capacities

Fuel Tank	40 liters (10.5 U.S. gall; 8.8 Imp. gall.), of these 5 liters (10.3 U.S. pints, 8.8 Imp. pints) as reserve.
Engine	2.5 liters (5.3 U.S. pints; 4.4 Imp. pints)
Rear Axle and Transmission	2 liters (4.2 U.S. pints; 3.5 Imp. pints)
Steering Gear Case	0.125 liter (0.26 U.S. pint; 0.22 Imp. pint)
Brake	0.25 liter (0.5 U.S. pint; 0.4 Imp. pint)

Performance

Maximum and Cruising Speed	110 km. (68 m. p. h.)
----------------------------------	-----------------------

	De Luxe Model		Standard Model	
Hill-Climbing Ability	First Speed	37 ⁰ / ₁₀₀ (20.5 ⁰)	37 ⁰ / ₁₀₀ (20.5 ⁰)	
	Second Speed	18.5 ⁰ / ₁₀₀ (10.5 ⁰)	20.5 ⁰ / ₁₀₀ (11.5 ⁰)	
	Third Speed	11 ⁰ / ₁₀₀ (6.5 ⁰)	11 ⁰ / ₁₀₀ (6.5 ⁰)	
	Fourth Speed	6 ⁰ / ₁₀₀ (3.5 ⁰)	6 ⁰ / ₁₀₀ (3.5 ⁰)	

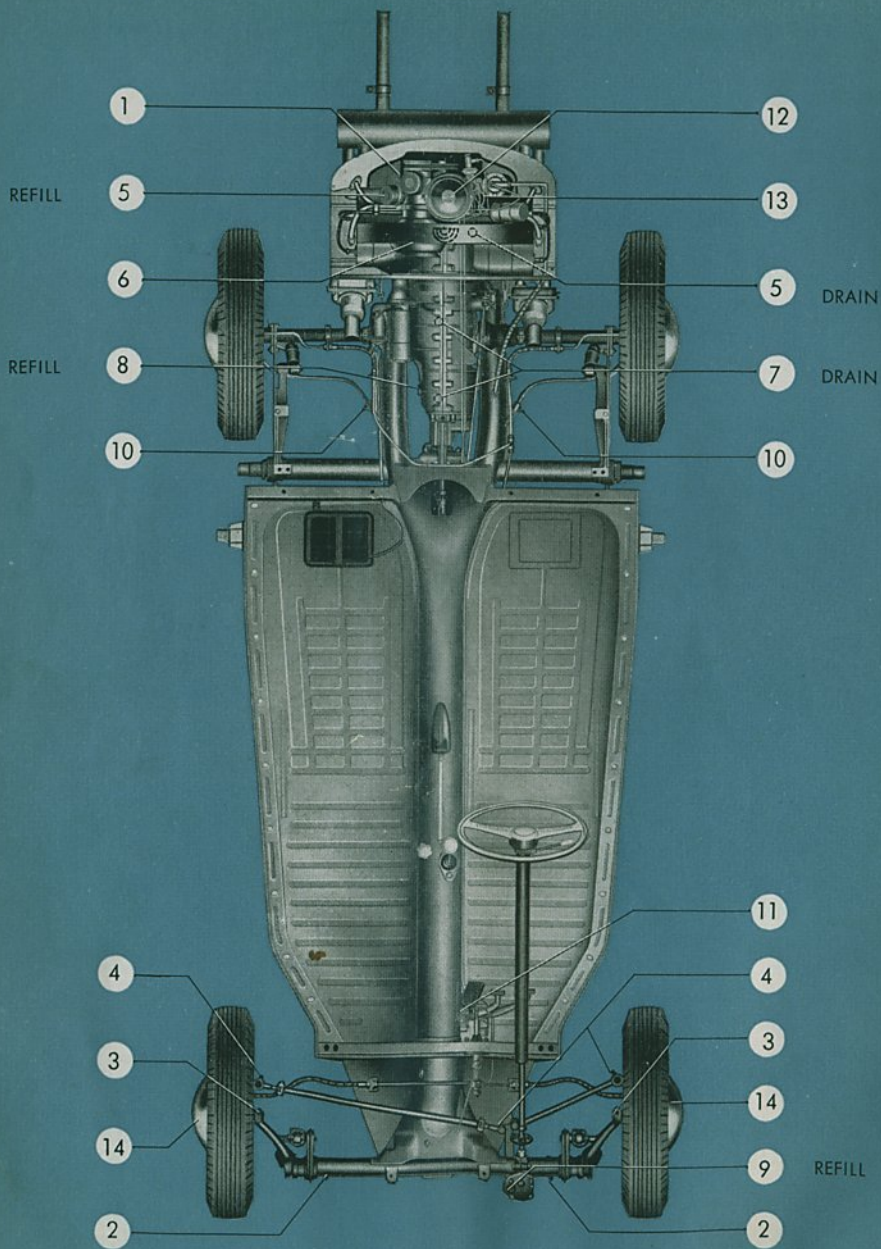

LUBRICATION CHART

At km./miles		Lubrication point	Lubrication points	Lubricant	Every
km./miles					
500	300	1	Engine: Check oil level, top up if necessary	M	2500 km. 1500 miles
		2	Front axle tubes	F	
		3	King pins	F	
		4	Tie rod ends Door hinges	F M	
		5	Engine: Change oil	M	5000 km. 3000 miles
		6	Engine: Clean oil strainer		
		7	Clean magnetic oil drain plugs		
		8	Transmission: Check oil level	G	
		9	Steering gear: Check oil level	G	
		10	Brake cables	F	
		11	Foot pedal cluster	F	
		12	Carburetor control linkage	M	
		13	Breaker arm fiber block in distributor Door and hood locks Convertible: Top linkages	F F M	
		7	Transmission: Change oil	G	25000 km. 15000 miles
		14	Front wheel bearings	W	
		13	Cam bearing in distributor	M	

LUBRICANTS

Lubricant	Lubrication points		Specifications				
			Temperature C	F			
Engine oil (HD oil for Otto-cycle engines)	Engine, oil bath air cleaner, carburetor linkage, door hinges, cam bearing in distributor, Convertible: Top linkages	M	above	+30°	+86°	SAE 30	
			from	0°	+32°	+86°	SAE 20 or
			up to	+30°	+86°		SAE 20 W
			below	0°	+32°		SAE 10 W
			below	-25°	-13°		SAE 5 W
Gear oil	Transmission case	G	above	0°	+32°	SAE 90	
	Steering gear	G	below	0°	+32°	SAE 80	
						SAE 90	
Universal grease	Front axle tubes, tie rod ends, brake cables, pedal cluster bearing, gearshift lever, breaker arm fiber block, door and hood locks, Convertible: Door hinges	F	Anti-freeze water-repellent grease				
Special grease	Front wheel bearings	W	Antifriction bearing grease				

MAINTENANCE CHART

At km./miles			Operation	Every	
km./miles 500 300	2500 1500	5000 3000			
			Check air cleaner, if necessary clean as prescribed	5000 km.	
			Check and adjust fan belt		
			Clean carburetor Check carburetor adjustment		
			Check breaker points and ignition timing		
			Check valve clearance		
			Examine battery		
			Check operation of lights, signals, and instruments		
			Check generator		
			Check spark plugs and compression		3000 miles
			Check steering gear adjustment		
			Check front wheel bearings, torsion arm link pins and toe-in		
			Check tire pressures and tighten wheel bolts From 5000 km. (3000 miles) onwards, rotate tires		
			Test brakes Check brake linings through inspection hole		
			Check tightness and effect of shock absorbers		
			Check clutch pedal clearance		
			Coat weather strips for doors and Convertible windows with talc powder		
			Check automatic cooling air control	10000 km.	
			Inspect rear axle and engine for oil leaks		
			Engine, especially exhaust, carburetor, intake manifold, and fuel pump	6000 miles	
			Chassis, body, front axle, rear axle, and steering		

} Check tightness
of nuts and
bolts

INDEX

	Page		Page
Accelerating – correct and wrong ..	22	Dimmer switch – headlight	5
Accelerator pedal	5	Direction indicator switch	5
– accelerating	22	Doors – care of weather strips	45
Accessories	111	– inside handle	5
Air cleaner – cleaning	46	– lubrication points	36
Ash receiver	17	Driving the Volkswagen	11
		Driving down-hill	15
Battery – maintenance	53	Economy	22/23
– care in winter	29	Engine – compression ratio	70
Body – airing the interior	45	– description	66
– description	68	– design	70
Brakes – adjusting	60/61	– lubrication (oil change) ..	30
– application	15	– oil change in winter	28
– bleeding	59	– oil level	8
– care in winter	29	– oil strainer	31
– checking	10	– speed	73
– description	68	– sectional view	65
Brake pedal	5	– technical data	70
Breaking-in (running-in) period? ..	21	– type of oil	32/33
Carburetor – adjusting	48	Fan belt – adjusting	47
– cleaning	48	– checking tension	8
– type	70	Foot brake – adjusting	59/60
Care of the car	40	– description	68
Chassis – care in winter	28	Front axle – description	67
– description	28	– lubrication	34/35
Chassis number	6	– technical data	72
Choke control knob	5	Front seats – adjustment	15
– application	11/12	– lubrication of seat	
Chromium-plated parts – care	44	runners	37
Climbing ability	73	Front wheel bearings – adjusting ...	63
Clutch – design	71	– lubrication	35
– pedal	5	Fuel consumption	73
– pedal free play	71	Fuel tank – capacity	10/73
Cold weather hints	27	– reserve	9
Controls and instruments	5	Fuel tap positions	9
Cooling of engine	71	Fuse boxes	55
		Fuses – exchanging	54
Dimensions – overall	73		

	Page		Page
Gear lever	5	Oil consumption	73
Gear shifting on gradients	22	Oil level – engine	8
Generator	71	– steering gear	34
Ground clearance	73	– transmission	33
Hand brake – adjusting	61	Paintwork – preservation	41
– description	68	– polishing	42
Headlight – aiming	56	Parking your car	26
– changing bulb	57	Passing other cars	25
Heating – description	68	Practical driving	21
– operation	27	Ratios – rear axle	72
Hood lock – control knob	5	– transmission	72
– Convertible	17	Rear axle – description	66
Horn button	5	– technical data	72
Idling – checking and adjusting	48	– transmission of power	72
Ignition – breaker point gap	52	Rear seat back	16
– distributor	71	Rear view mirror	25
– firing order	71	Reverse gear	13
– lubrication of distributor	33	Safety in traffic	25
– timing	52	Seat adjustment	15
Instrument light	10	Sectional view with explanations ..	80
Interior light	17	Shifting gears	13
Jack – application	37	Shock absorbers – design	72
– location	18	Spare wheel	38
Key – doors and ignition	6	Spark plugs – checking and cleaning ..	51
License plate light – replacing bulb ..	58	– gap	51
Light switch – positions	10	– removal	51
Lubricants	75	Speedometer	5
Lubrication	30	Speed ranges	21
Lubrication chart	75	Spots – removal	44
Maintenance	46	Starting – danger in enclosed	
Maintenance chart	76	spaces	12
Maximum output	70	– in winter	11
Maximum speed	71	– with engine cold	11
Model detail plate	6	– with engine hot	12
Non-Skid chains	29	Starting motor	71
		Steering – adjusting	62
		– type	72
		Steering wheel	5
		Stop light – bulb replacement	58
		– checking	10

	Page		Page
Stopping the car – generally	14	Warning lights – direction indicator	24
– temporarily	24	– generator and cooling	24
Sun roof – cleaning	43	– headlight	24
– opening and closing	18	– oil pressure	24
Suspension – front	72	– replacing bulbs	58
– rear	72	Washing your car	40
Tail light – replacing bulb	58	Weights	73
Technical data	70	Wheel base	72
Tires – inflation pressure	11	Wheels – balancing	38
– maintenance	38	– changing	38
– M + S tires	29	– rim size	72
– size	72	Window regulator – lubrication	36
– wear	38	Window regulator handle	5
Toe-in of front wheels	72	Window weather strips – care	45
Tools and accessories	III	Windshield wiper switch	5
Track (tread)	72		
Transmission – description	68		
– oil change and capacity	28/32		
– sectional view	69		
– technical data	72		
Turning circle	72		
Type of fuel	11		
Upholstery – care of cloth	44		
– imitation leather	45		
– leather	45		
Valves – adjusting	50		
– arrangement	70		
– clearance	70		
Vent wing	5		



VW Sedan, Sectioned

- 1 - Spare tire and wheel
- 2 - Brake fluid reservoir
- 3 - Steering gear
- 4 - Front axle and square torsion bars
- 5 - Fuel tank
- 6 - Fuel tap
- 7 - Brake master cylinder
- 8 - Pedal linkage
- 9 - Speedometer
- 10 - Gear lever
- 11 - Heating control
- 12 - Direction indicator switch
- 13 - Hand brake lever
- 14 - Vent wing handle
- 15 - Battery
- 16 - Socket for car jack
- 17 - Rear torsion bar
- 18 - Transmission
- 19 - Starting motor
- 20 - Differential
- 21 - Clutch
- 22 - Shock absorber
- 23 - Crankshaft
- 24 - Camshaft
- 25 - Oil strainer
- 26 - Fan housing
- 27 - Oil pump
- 28 - Generator
- 29 - Muffler (Silencer)
- 30 - Carburetor
- 31 - Oil bath air cleaner

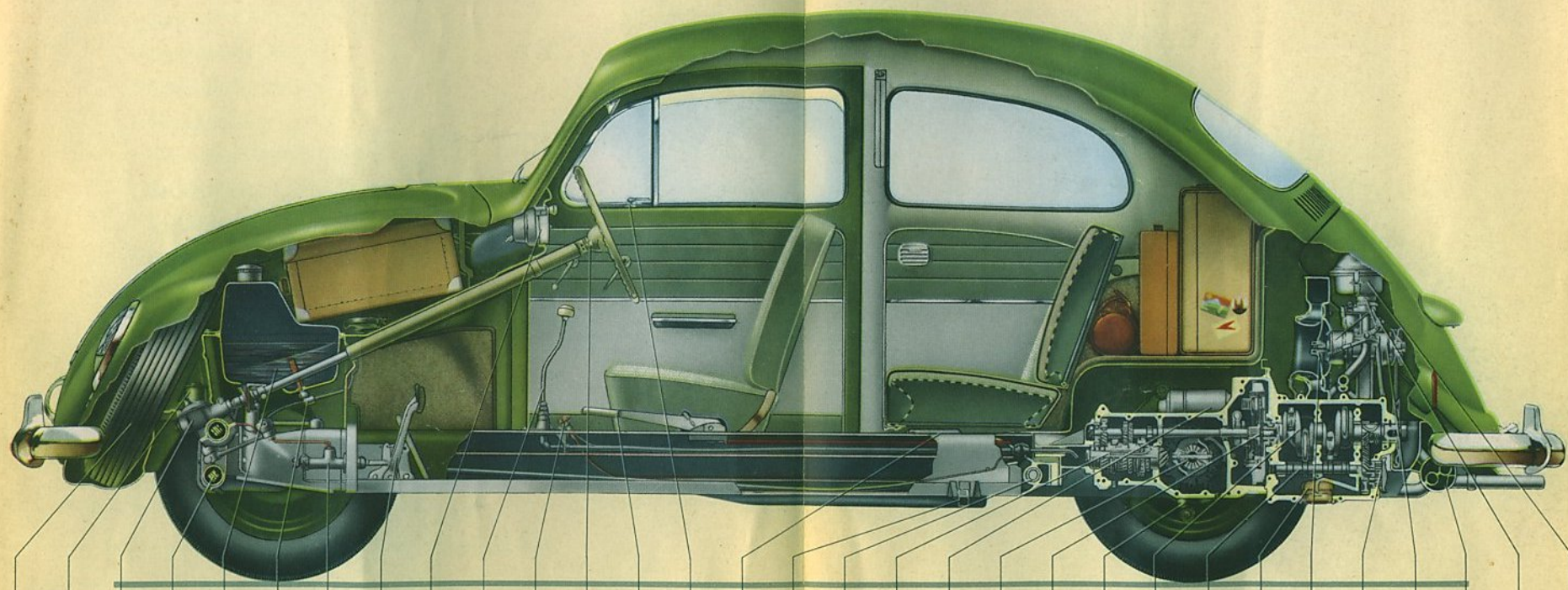

1 2 3 4 5 6 7 8 9 10 11 12 13 14 15 16 17 18 19 20 21 22 23 24 25 26 27 28 29 30 31

Tools and Accessories

- 1 Spare Fan Belt
- 1 Tool Roll
- 1 Spare Tire and Wheel, complete
- 1 Jack
- 1 Combination Pliers
- 1 Screwdriver 0.8 mm.
- 1 Screwdriver 0.5 mm.
- 1 Open End Wrench 8/12 mm.
- 1 Socket Wrench for Spark Plug, Fan Pulley Nut, Wheel Disc Bolt
- 1 Socket Wrench 14 mm.
- 1 Rod for Socket Wrench and Jack

The VOLKSWAGENWERK G. m. b. H.

reserves the right to make any changes in or improvements on its products without imposing any liability or obligation upon itself to install them on its products previously manufactured.

All rights reserved in accordance with the law of copyright.

