

# VOLKSWAGEN 1500

Instruction Manual

3

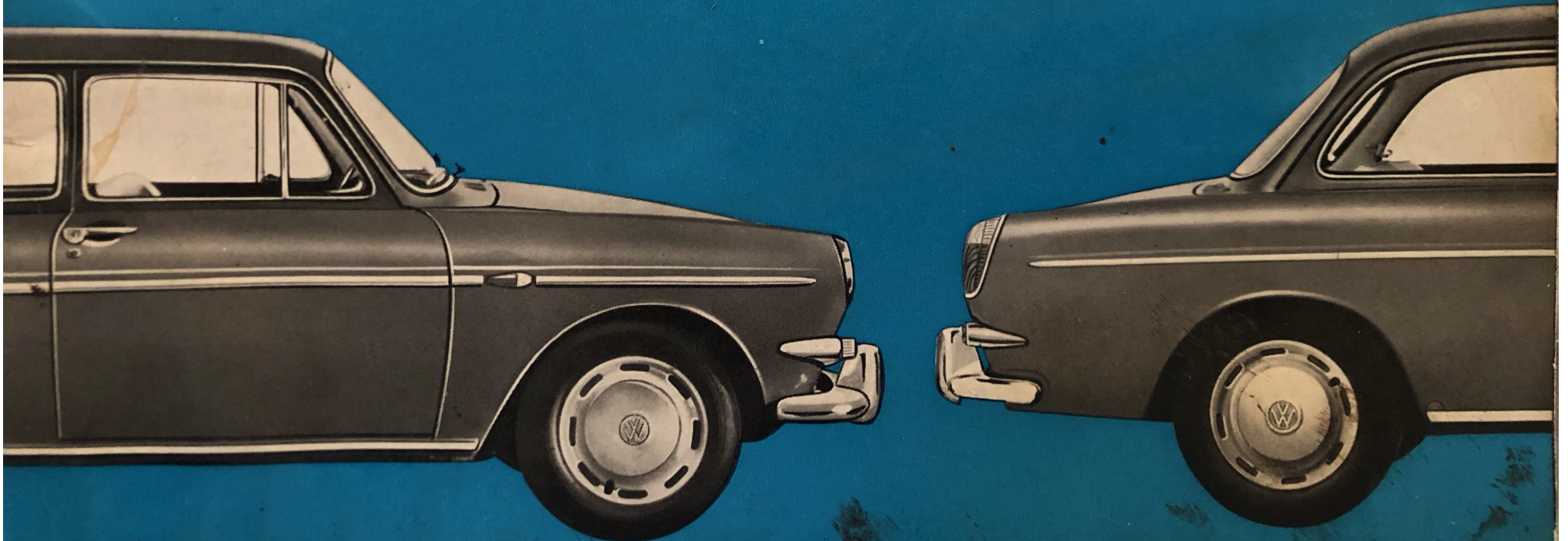

# VOLKSWAGEN 1500 E

Instruction Manual

August 1963

V O L K S W A G E N W E R K A G . W O L F S B U R G

Handwritten notes and calculations in pencil:

- 42918
- 51080
- 51455
- 165
- 333.00
- 5
- 16500
- 15
- 160
- 200
- 32000
- 51455
- 51382
- 73
- 860
- 81
- 50
- 27
- 23



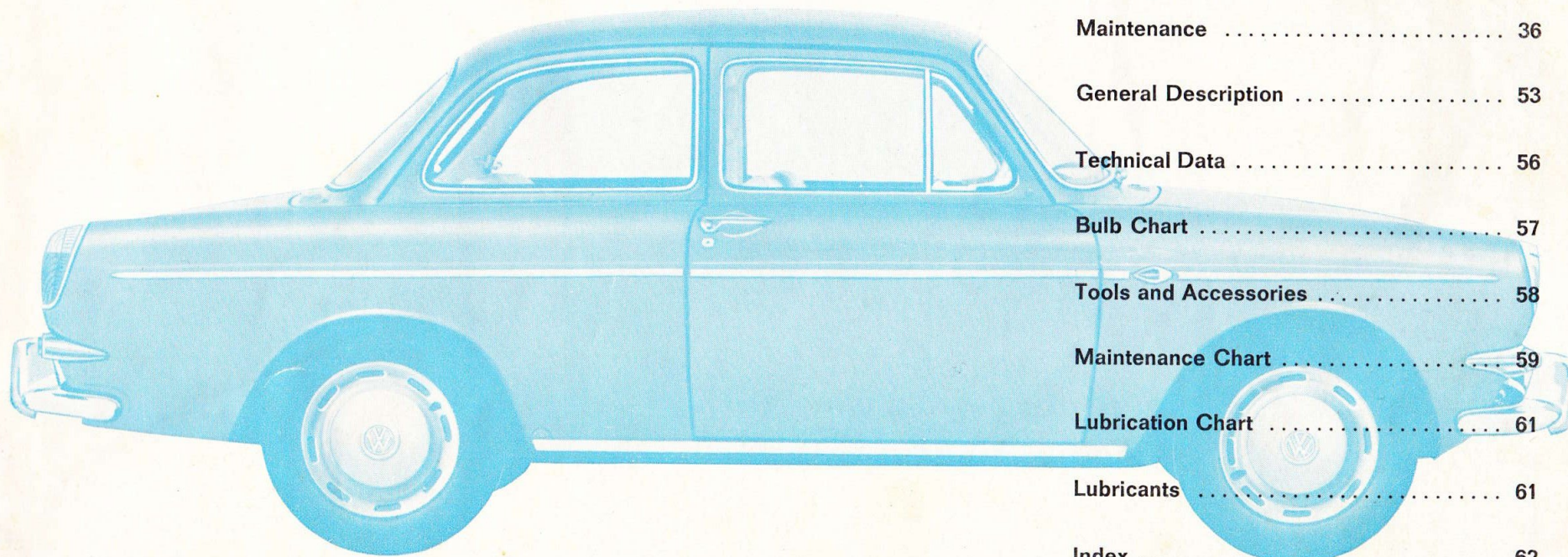

Identification Plate, Chassis and Engine Number .....	4
Controls and Instruments .....	5
Operating Instructions .....	6
Practical Driving .....	20
Cold Weather Hints .....	24
Care of the Tires .....	26
Care of the Car .....	28
Lubrication .....	31
Maintenance .....	36
General Description .....	53
Technical Data .....	56
Bulb Chart .....	57
Tools and Accessories .....	58
Maintenance Chart .....	59
Lubrication Chart .....	61
Lubricants .....	61
Index .....	62

**Identification plate, Chassis and Engine Number.** Among the vehicle documents you will find details regarding the model, year of construction, chassis and engine numbers. The police or Traffic Department attach much importance to these details.



**The identification plate** is found under the front hood beside the hood lock.



**The chassis number** is found on the frame tunnel under the rear seat.

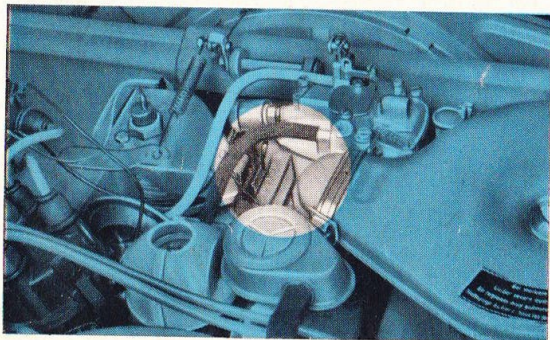

**The engine number** is found on the left-hand crankcase half between the oil cooler and the crankcase joint.

- 1 - Vent wing handle
- 2 - Switch group for windshield wipers, windshield washer and lighting
- 3 - Warning light — Green — Parking lights
- 4 - Warning light — Green — Flashing indicators
- 5 - Warning light — Blue — Headlight high beam
- 6 - Warning light — Red — Generator
- 7 - Warning light — Green — Oil pressure
- 8 - Fuel gauge
- 9 - Speedometer
- 10 - Clock
- 11 - Ash tray
- 12 - Fresh air ventilation lever — Windshield, left
- 13 - Fresh air ventilation — Foot level
- 14 - Fresh air ventilation lever — Windshield, right
- 15 - Inner door handle
- 16 - Locking lever
- 17 - Window winder
- 18 - Front hood control knob
- 19 - Fuse box
- 20 - Flashing indicator switch
- 21 - Horn lever
- 22 - Clutch pedal
- 23 - Brake pedal
- 24 - Accelerator pedal
- 25 - Steering ignition lock
- 26 - Hand brake lever
- 27 - Heating control lever
- 28 - Control lever for heating in rear foot well
- 29 - Gear lever

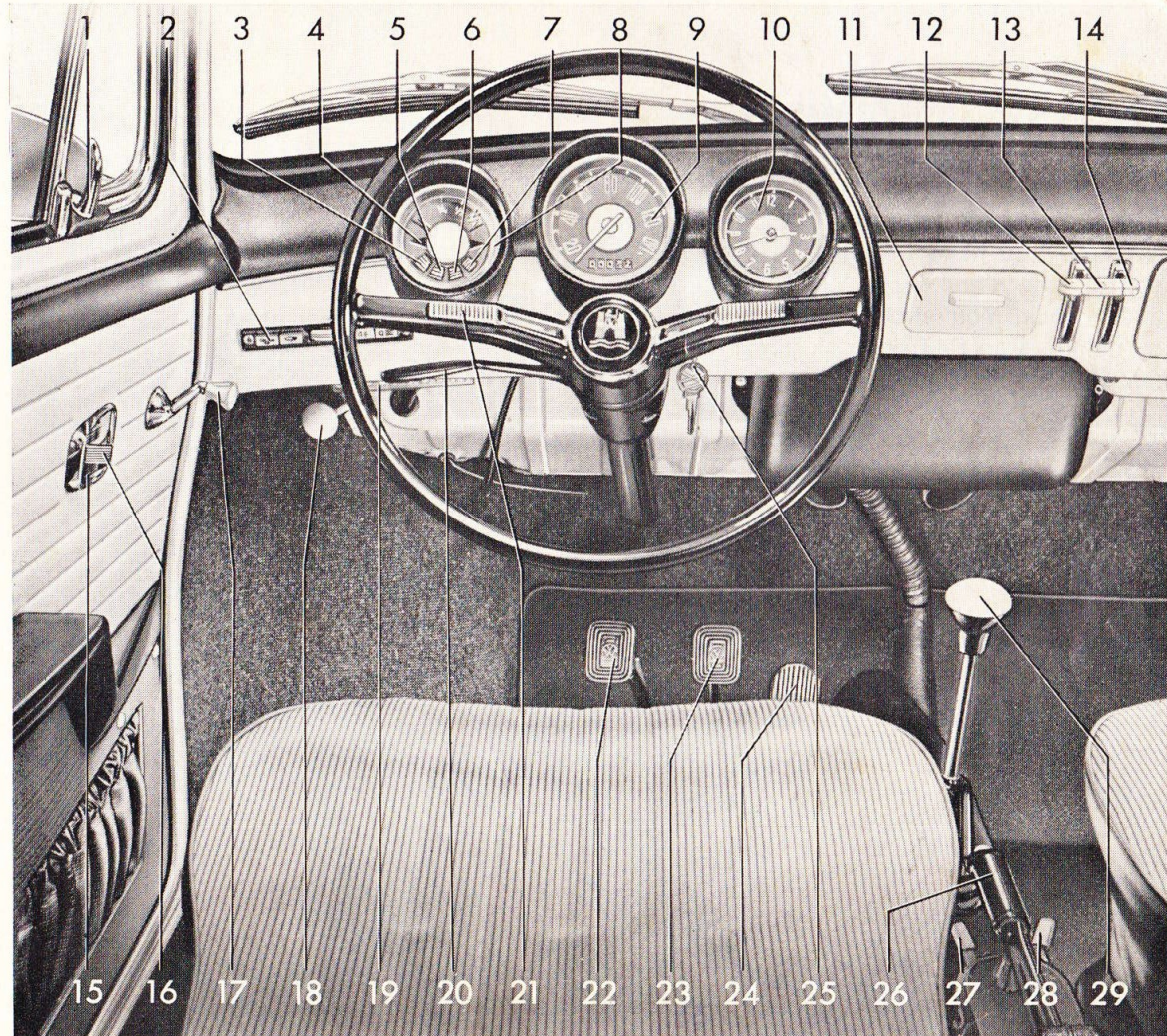

## Operating Instructions

**Before driving off** acquaint yourself with the VW 1500. You have been given a separate key for the door locks and the steering ignition lock. You should take note of the key numbers so that you can get a replacement if you should lose a key.

**Both Doors** can be unlocked from the outside. A quarter of a turn with the key and the door can be opened by means of the press button under the door handle.

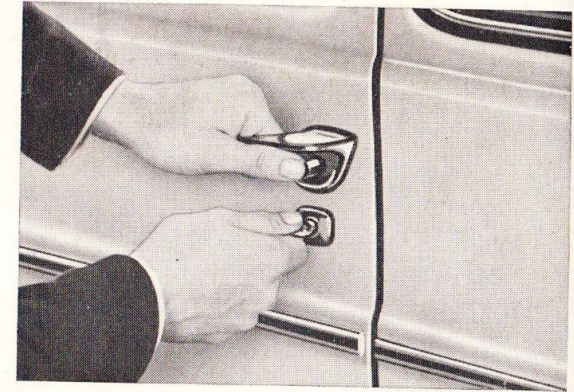
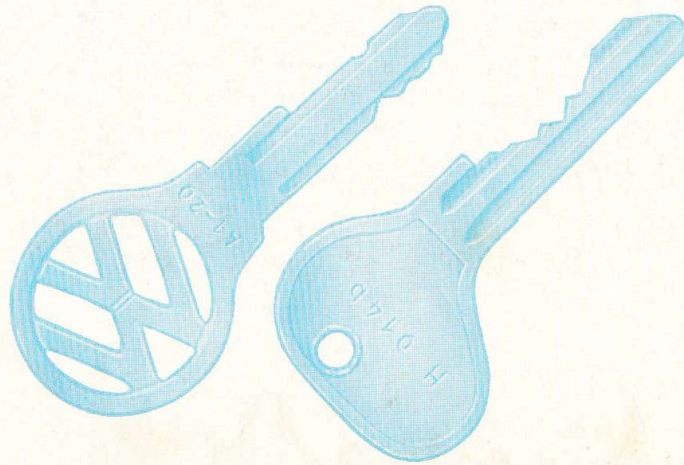

**Both doors** can be locked from the outside. It is, however, more convenient to push in the lever above the inner door handle and to depress the button below the outer door handle. If the door closes unintentionally after the inner lever has been depressed it will not lock and thus the danger of getting locked out is reduced to a minimum.

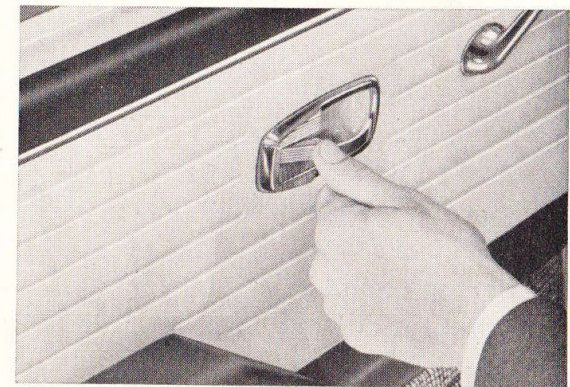

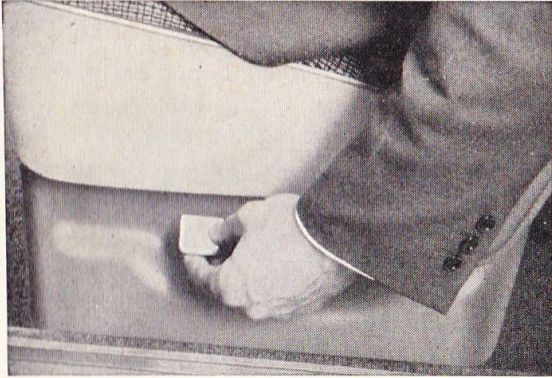

**The Front Seats.** The seats can be adjusted individually whilst driving, by merely pulling up the lever under each seat.

The rake of the front seat backs can be adjusted to eight different positions by turning a knob.

When the doors are closed a special locking device secures the seat backs and prevents them from tilting forward. To remove the front seats, press down the leaf spring on the inner runner. This spring prevents the seat from sliding out to the front unintentionally.

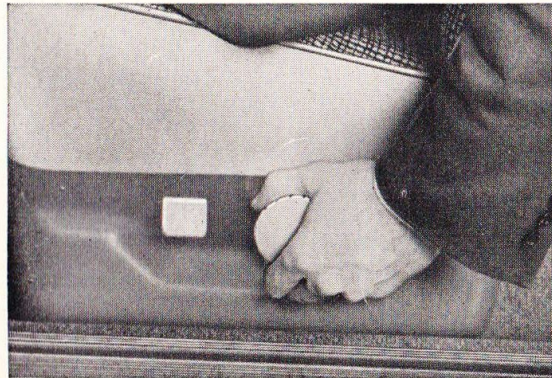

**The Rear View Mirrors** are adjustable and should be set to give clear vision to the rear at all times without having to alter ones position.

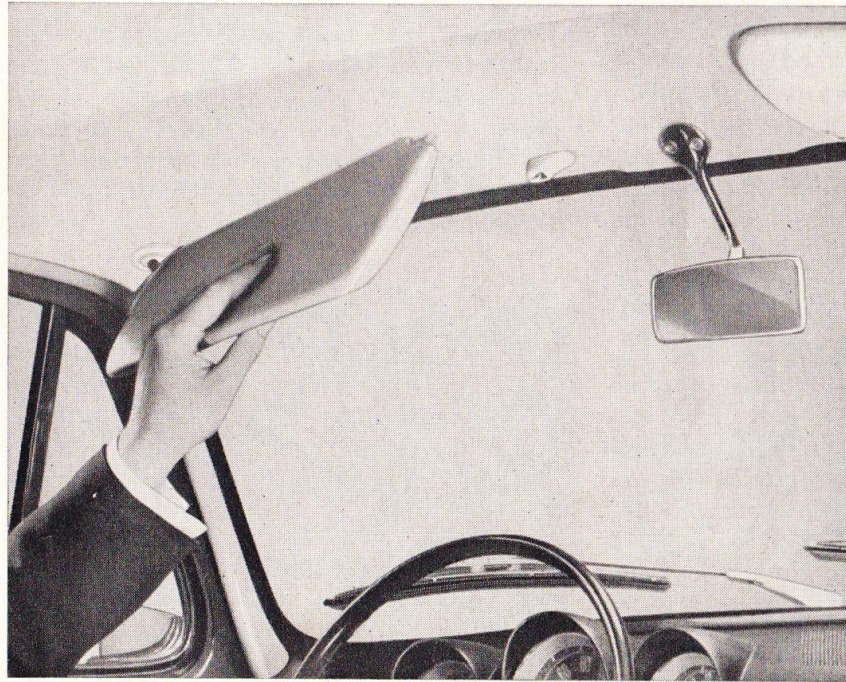

**The Sun Vizors** can be swivelled towards the door windows and offer protection against the sun from the side.



**The Windshield Wipers and Washer** are operated by both of the buttons on the left of the switch group on the instrument panel. Furthest to the left is the windshield washer button and beside it the button for the wipers. The wiper speed can be regulated by the upper knurled disc in the center of the switches. Press in the button fully and release it to switch off the windshield wipers which are self-parking.

The windshield washer is pneumatically operated. The water container beside the spare wheel under the front hood has a capacity of approximately 2 liters (2 quarts). Do not forget to refill the container from time to time. As the air pressure in the container escapes when the cap is removed, it is advisable to refill the container at a filling

station. The container can be filled until it overflows. The pipe in the container neck ensures that there is always sufficient air to operate the washer.

The correct air pressure is 2.5 kg./cm<sup>2</sup> (36 psi.). The addition of 25 % pure spirit to the water in winter will protect it from freezing down to a temperature of approximately -12° C (10° F). An odourless anti-freeze solution can be used instead of methylated spirits. The correct mixing proportions will be stated by the manufacturers.

The wiper blades should be removed occasionally and thoroughly cleaned with a hard brush and methylated spirits or a strong detergent solution. Particularly during long dry periods they tend to become clogged with tar splashes, oil and insects. The blades should be replaced once a year.

**The Lights** are switched on with the two right-hand buttons of the switch group. When the parking lights are switched on, a green warning light comes on in the fuel gauge. The parking lights come on automatically when the headlights are switched on. The dimmer switch is incorporated in the flashing indicator lever.

To switch out all the lights all you have to do is to fully depress the parking light button. The button for the head lights springs out automatically. If, however, you wish to switch out the headlights only, merely press the right-hand button.

**The Instrument Panel Lighting** can be regulated by the lower knurled disc in the center of the switch group and can be switched off by turning the disc fully to the right.

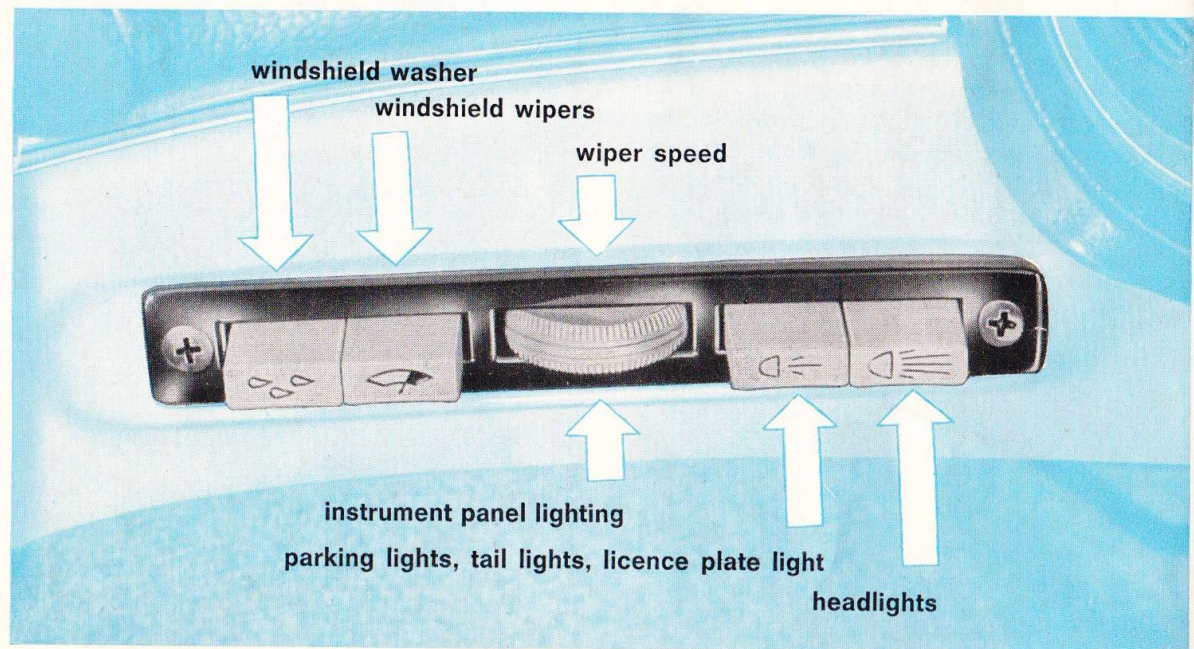

**The Interior Light** is situated above the left door. The switch is operated by pushing in the light by hand as follows:

Light in central position  
Interior light comes on when a door is opened

Light pressed in on right  
Interior light switched on, with doors closed

Light pressed in on left  
Interior light switched off, with doors open

**Flashing Indicator Lever.** You can operate the flashing indicator lever with your fingers without taking your hands off the steering wheel. Together with the button situated in it, the indicator lever has four functions:

With the ignition switched on the flashing indicators are operated:

Lever upwards - right flashing indicator  
Lever downwards - left flashing indicator

Two warning lights in the fuel gauge flash whilst the indicators are in operation. The indicators are self-cancelling.

With the lever in the same positions and the ignition switched off, the left or right parking lamp is illuminated. The parking lamps are positioned on the sides of both front fenders.

When the headlights are switched on the button in the indicator levers serves as dimmer switch. A blue high beam warning light is situated in the fuel gauge.

The button in the indicator lever operates the headlamp flasher when the headlights are switched off or when the parking lights are on. If the button is kept depressed the high beam comes on when the lights are switched off, and the low beam when the parking lights are on.

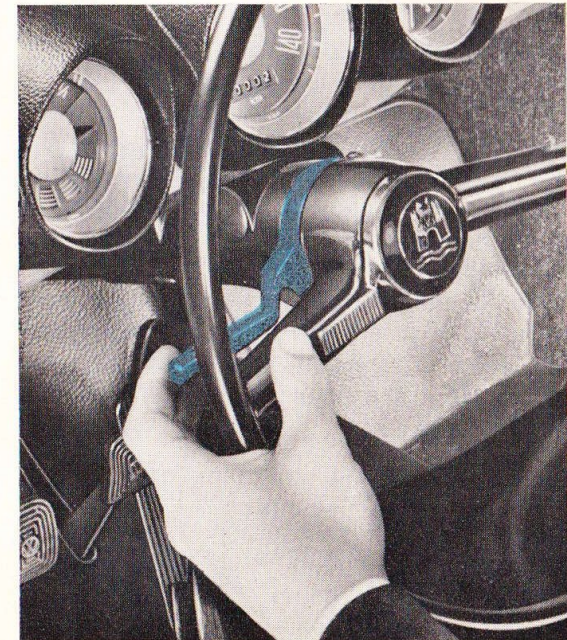
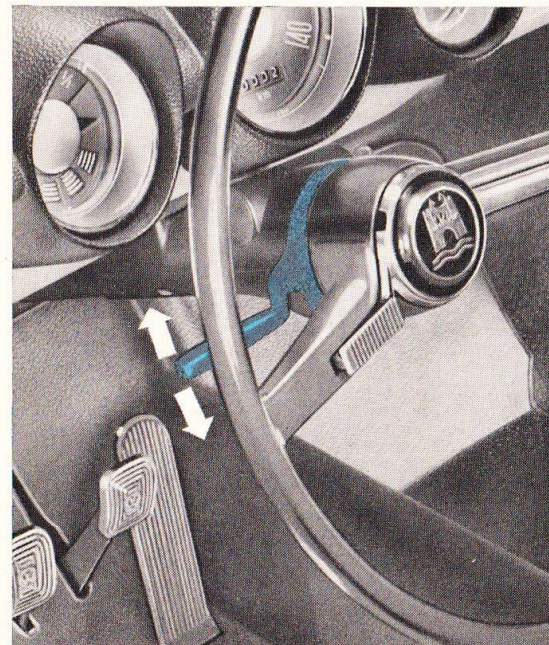
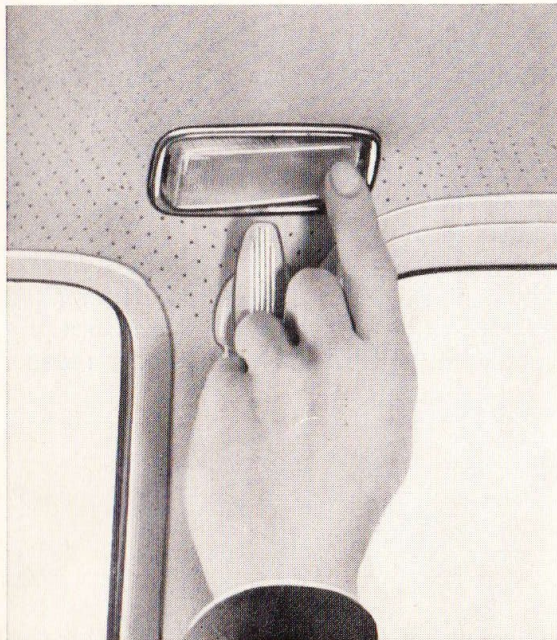

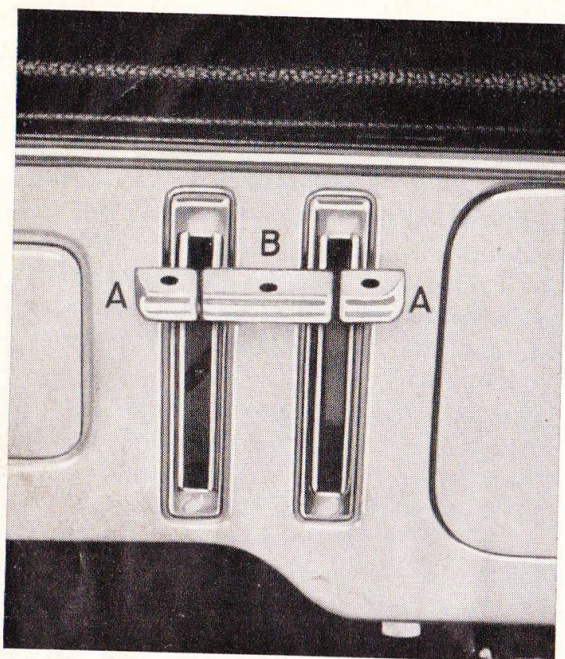

### Fresh Air Ventilation

The fresh air ventilation can be regulated by the three levers on the instrument panel. The two outer levers — A — operate the ventilation for each side of the car individually through two vents on the lower edge of the windshield. The center lever — B — regulates the ventilation at foot level. The amount of fresh air entering will increase the further the levers are pushed down. When all three levers are in the upper position, the ventilation is closed.

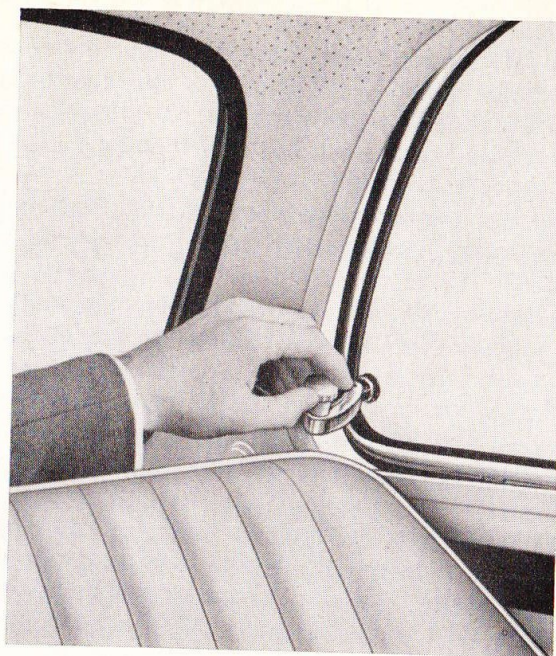

Further ventilation is provided by the vent wings in the door and the hinged quarter windows.

The warm and fresh air must be cleared to ensure correct vehicle ventilation. Even in cool weather a vent wing or hinged window should be slightly opened. The windows will then remain clear.

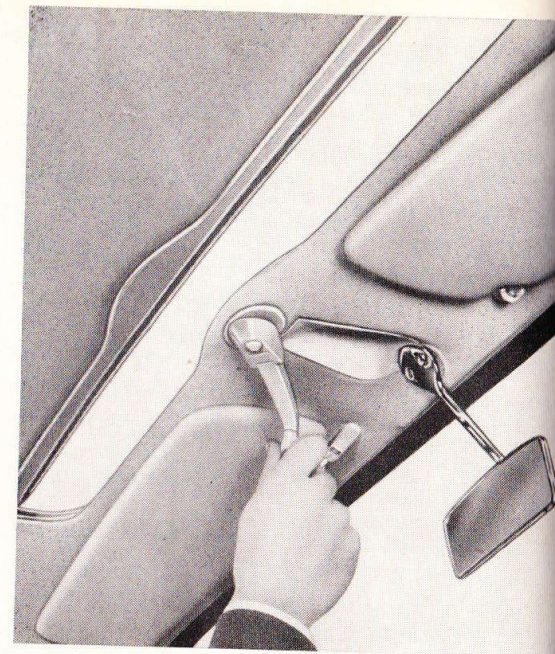

**The sliding roof** is operated by a crank which is situated in a recess between the sun vizors.

After pulling down the handle, the roof can be opened or closed as required. It will remain fixed in any position.

When closing, the sliding roof is cranked fully forward to the stop. Now turn the handle back a little and fold it into the recess.



**The Clock** is electrically operated. The hands can be moved by turning the knob in the center of the dial.

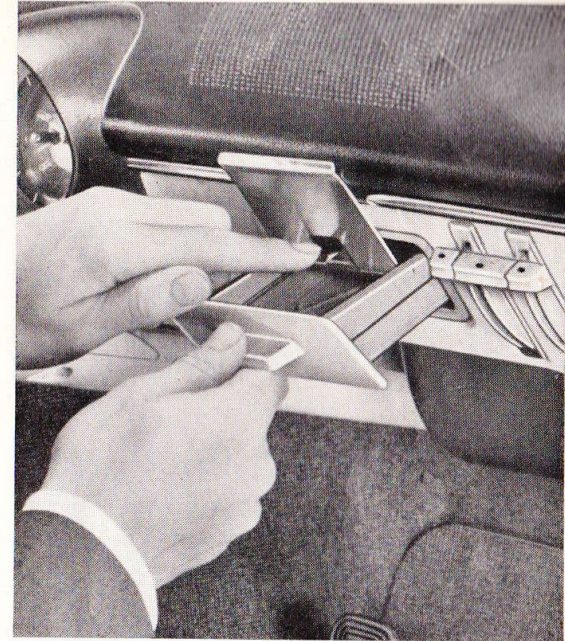

**The Ash Tray in the Instrument Panel** can be removed by depressing the spring.

When removing the rear ash trays, lift them out of the bottom of the housing first and when inserting, engage them in the spring first and then press into the housing.

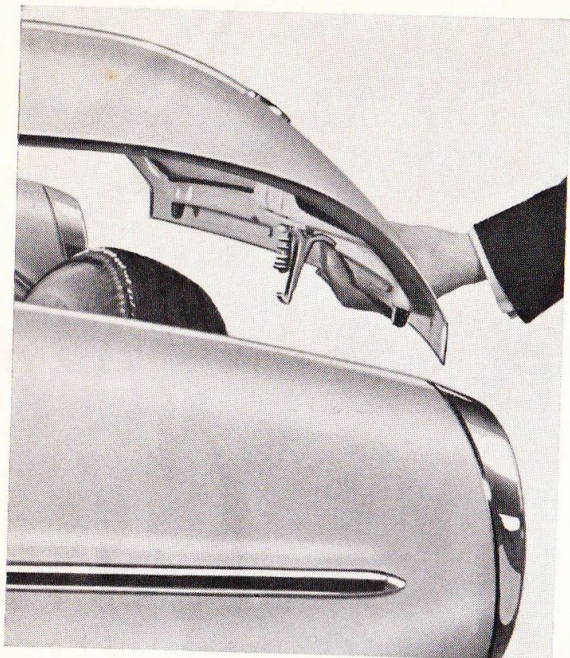

**The Luggage Compartments** are theft-proof when the car is locked. The knob for the front hood is situated under the instrument panel on the left. The hood is released when the knob is pulled and is opened by pressing up the catch beside the lock.

When closing the hood, ensure that the lock engages firmly. Never attempt to close the hood by pressing at the side, always press it near the lock.

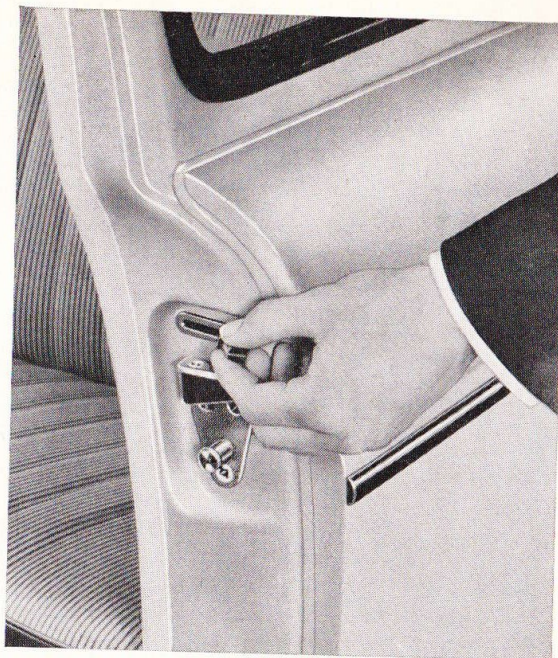

The rear hood is opened by pulling the lever in the left-hand lock pillar.

The light in the rear luggage compartment operates only when the lights are on and goes out when the hood is closed.

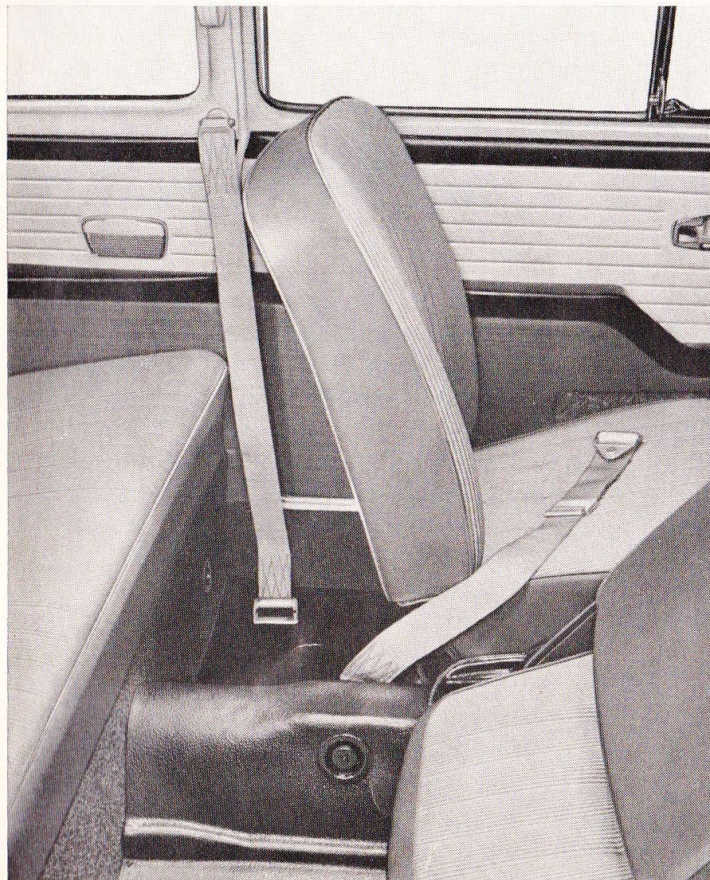
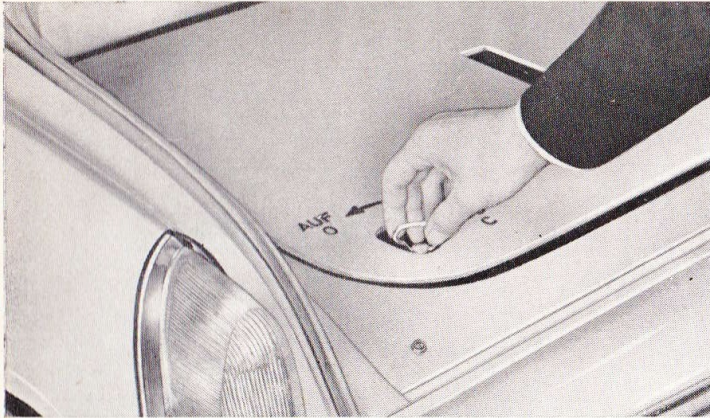

**The Engine Compartment** is accessible from the rear luggage compartment. Release the buttons and roll back the lining. Turn the handles on the engine compartment lid to the left, raise the lid and secure it by pressing it against the spring on the upper edge of the luggage compartment. If you wish the luggage compartment light to illuminate the engine, remove the engine compartment lid.

Turn the handles to the right to lock the engine compartment lid and secure them by pressing them down fully.

### **Safety Belts**

can be obtained from every VW Dealer. The belts for the driver and front passenger are attached to the lock pillar and the frame tunnel. You will find the mountings for the rear seat passenger belts to the left and right of the rear seat back rest and under the back rest above the frame tunnel.



### **Variant**

Apart from the front luggage compartment there is also a large load compartment which is accessible through the rear door.

**The Rear Door** is opened by the knob under the licence plate. Lift the door by the recess under the knob. It is held in the fully open position by spring tension.

When closing it you merely have to slam it gently until it engages in the lock. It is locked by the same key which you use for the two doors.

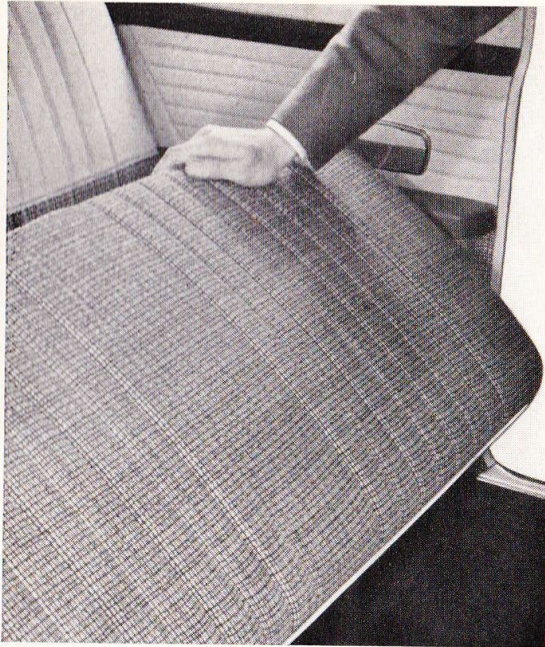

**The Loading Surface** can be increased by more than half its size by tipping the rear seat forward. To do this, raise the seat cushion and tip the backrest forward with the handle.

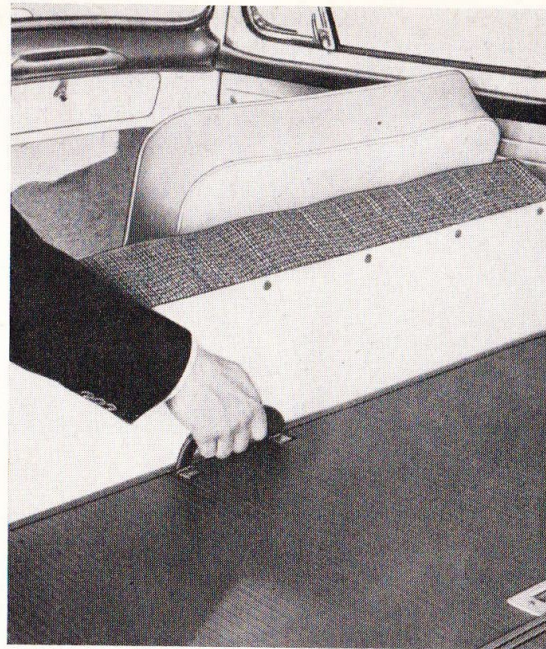

When the seat has been tipped forward the seat cushion and backrest are held by two retaining pins. In the normal position a retaining device automatically prevents the backrest from tilting forward.

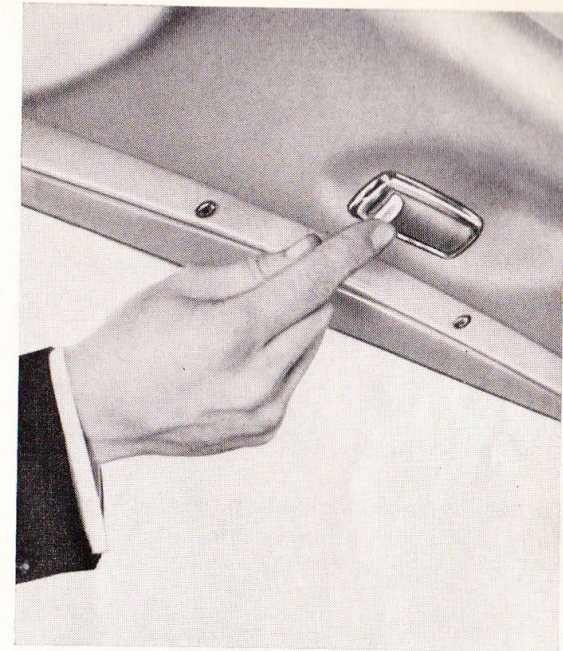

### **The Load Compartment Lighting**

An additional interior light for the load compartment is situated on the roof member above the rear door.



### Before driving off

check the brakes, lighting, amount of fuel and at regular intervals the oil level and tires of your car.

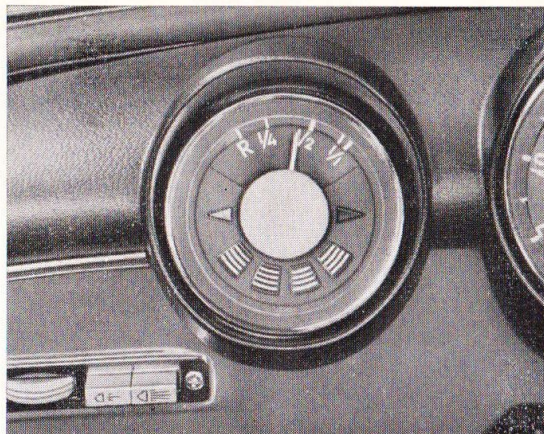

The fuel tank capacity of 40 liters (10.6 US gall.; 8.8 Imp. gall.) is sufficient for 450 km (279 miles). When the ignition is switched on the fuel gauge in the instrument panel will show you how much fuel you actually have. When the needle registers "R" (reserve) it is time to fill up at the next opportunity. The remaining 5 liters (1.3 US gall.; 1.1 Imp. gall.) in the tank will last for about 55 km (34 miles).

The choice of fuels is left to you. The engine of your car is so designed that it will run satisfactorily on all normal reputable fuels. All good brands, including premium and regular mixtures, are distinguished by their consistent composition, adequate anti-knock properties and freedom from harmful ingredients. The fuel tank filler is under the front hood which is opened by the knob under the instrument panel.

The Brakes must be checked before starting out on a trip as the safety of your car depends mainly on them. When the car is in motion, depress the brake pedal a few times to make sure that the brakes are working efficiently.

The stop and flashing indicator lights are an essential part of the lighting system. The ignition has to be switched on if you wish to check them.

If a flashing indicator bulb is defective, the warning lights in the fuel gauge will come on and go out again. Moreover, the other indicator on the same side of the car will flash considerably quicker.

The stop lights re-act to the foot brake only.

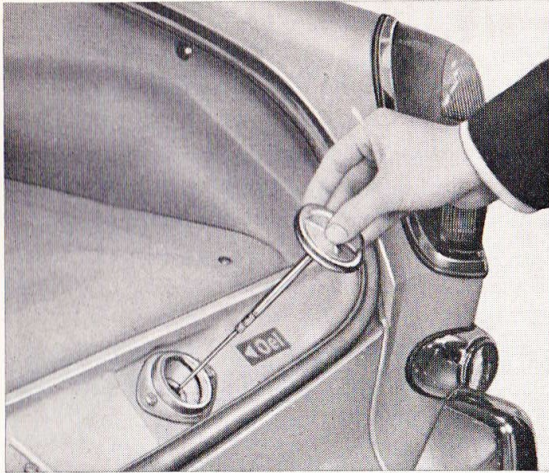

**The oil level** should only be checked when the engine is not running. It must always be between the two marks on the dipstick and must never fall below the lower mark. Wipe the dipstick with a clean rag before checking the oil level.

If possible always use the same branded HD oil (for Service MS). It is not good practice to mix various brands of oil.

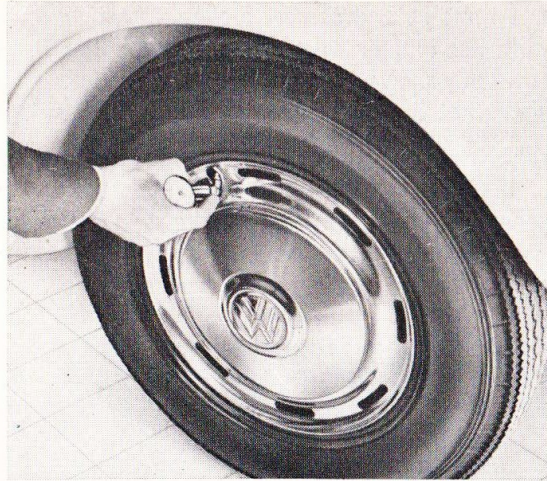

### Tires

Correct tire pressures are essential for ensuring the excellent road-holding properties of your car. It is not too much to be expected for you to check the tire pressure occasionally.

When the car is fully loaded, or when driving fast on long journeys the front tire pressure should be 1.2 kg/cm<sup>2</sup> (17 psi.) and 1.7 kg/cm<sup>2</sup> (24 psi.) at the rear. Otherwise 1.1 kg/cm<sup>2</sup> (16 psi.) pressure in the front is sufficient.

Variant — 375 kg (827 lbs.) —:

with half payload

front 1.2 kg/cm<sup>2</sup> (17 psi.)

rear 1.7 kg/cm<sup>2</sup> (24 psi.)

with full payload

front 1.2 kg/cm<sup>2</sup> (17 psi.)

rear 2.5 kg/cm<sup>2</sup> (36 psi.)

Variant — 460 kg (1014 lbs.) —:

with half payload

front 1.2 kg/cm<sup>2</sup> (17 psi.)

rear 1.7 kg/cm<sup>2</sup> (24 psi.)

with full payload

front 1.2 kg/cm<sup>2</sup> (17 psi.)

rear 2.7 kg/cm<sup>2</sup> (38 psi.)

## Starting the Engine

The ignition and starter are switched on, one after the other, by means of the steering ignition lock. As starter operation stresses the battery heavily, other big current users, such as the headlights, windshield wiper and radio, should not be switched on when starting. Make sure, also, that the gear shift lever is in neutral.

When switching on the ignition, turn the key half a turn from the "Halt" position or a quarter of a turn from the "Garage" position to the right. The red generator warning light and the green oil pressure warning light in the fuel gauge will come on. Operate the starting motor immediately by turning the key further to the right.

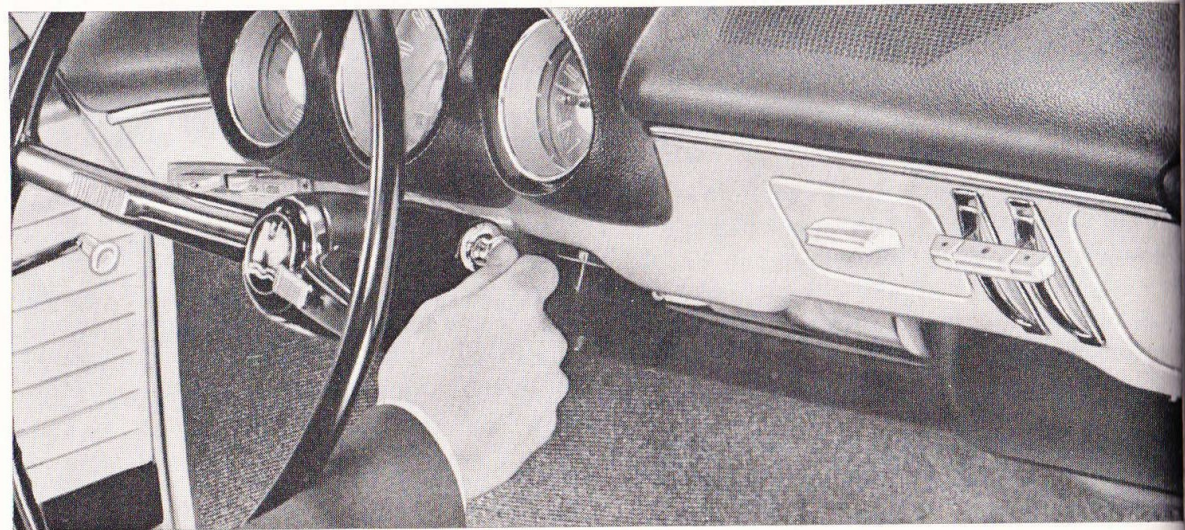

**At temperatures above freezing point** or when the engine is still warm, depress the accelerator pedal slightly while operating the starter. Depress the acceleration pedal fully only when the engine is very warm.

**At temperatures below freezing point** and when the engine is cold, depress the accelerator pedal fully and then release it before switching on the ignition. This enables the automatic choke to close the choke valve. As the engine and transmission oil tend to become thick when cold, you should also declutch when starting so that the starter motor only has to turn the engine.

As soon as the engine starts, release the ignition key so that the starter is switched off. You can move off at once. The automatic choke regulates the mixture and idling speed to suit the operating temperature. Do not race the engine when it is still cold.

If the engine does not start within the first 10 seconds, pause for about the same length of time to rest the battery before repeating the starter operation. The ignition will have to be switched off first and then on again as a non-repeat lock in the switch prevents the starter from being operated repeatedly when the ignition is on and thus being damaged by the engine when it is running. The starting procedure should not be interrupted if the engine is heard to fire a few times without starting.

**The generator warning light** goes out when the speed is increased. If it comes on while you are driving, the generator is no longer charging. In this case you can proceed but, if possible, only as far as the next workshop as otherwise the battery will soon get run down.

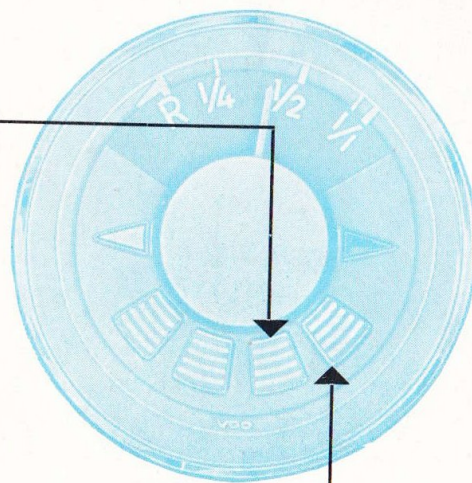

**The warning light for the oil pressure** goes out when the engine is started. If this warning light comes on whilst driving you must stop at once as the chances are that the oil circulation has been interrupted. Check the oil level at once. If the oil level is correct, get in contact with the nearest VW workshop.

An occasional flashing of the light when the engine is warm and running at low speeds does not indicate trouble.

#### Caution

Be careful when starting the engine in the garage. Provide ample ventilation so that the exhaust fumes, which contain carbon-monoxide gas, can escape.

## Practical Driving

**Breaking-in instructions** are not necessary for your VW 1500. The most modern production and inspection methods have made it possible to dispense with the initial speed restrictions which are normally required. You can drive the vehicle at full speed from the first day. It is advisable, however, to observe certain general driving rules.

### Gear Shifting

Glance occasionally at the speedometer especially during the initial period.

Shift the gears within the permissible speed ranges only:

0 to 25 kph (0—15 mph)

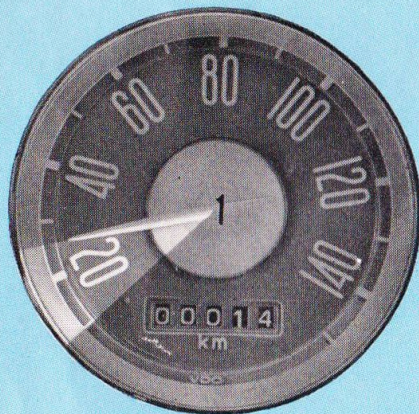

You can drive very economically between:

10 to 55 kph (6—34 mph)



10 and 35 kph (6 and 21 mph)

25 to 85 kph (15—52 mph)

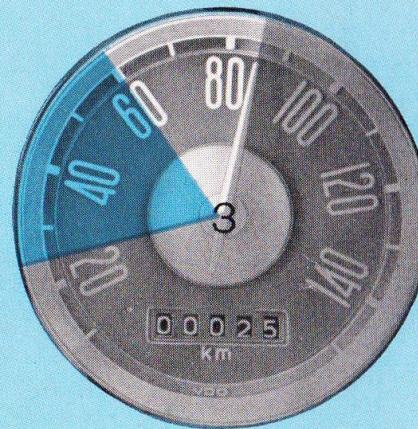

25 and 60 kph (15 and 37 mph)

40 to 125 kph (25—78 mph)

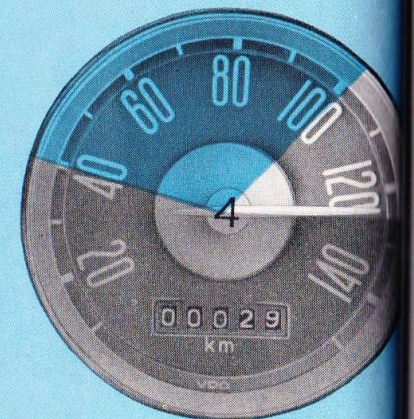

40 and 100 kph (25 and 62 mph)

Do not race or labor the engine in the individual gears. This practice can have a decisive effect on the life of the engine.

A few instructions on clutch operation:

Shift to first gear shortly before moving off only.

When stopping temporarily do not wait with the clutch pedal depressed and a gear engaged.

Do not use the clutch pedal as a footrest when driving.

Engage the reserve gear only when the car is stationary. A locking device prevents unintentional shifting. Depress the gear lever slightly and then move it to the left and to the rear to engage reverse.

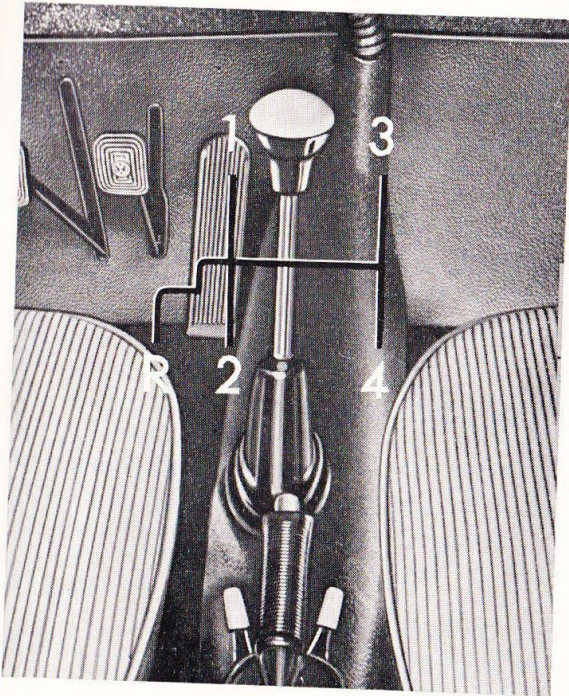

### Shifting to a lower gear

Shift down to a lower gear in good time when on inclines and also when accelerating from low speeds. The transmission of your car is fully synchronized so please do not hesitate to shift the gears.

Certain speed ranges have to be adhered to when shifting to a lower gear. Shifting down to a lower gear at excessive speeds puts an unnecessary strain on the transmission. On the other hand very low speeds in the individual gears are harmful to the engine. Shift down from 4th to 3rd gear approximately between 85 and 40 kph (52 and 25 mph) and from 3rd to 2nd gear between 55 and 25 kph (34 and 15 mph). The 1st gear is only used for moving off, driving at walking pace or on very steep inclines.

When shifting gears, it is absolutely essential to depress the clutch pedal fully. Incomplete declutching makes gear shifting difficult and leads to rapid wear of the synchronizer stop rings.

**Economical operation** is one of the outstanding features of your car. However, getting a few extra miles from each gallon depends on your driving habits:

Make use of the lower speed ranges of the individual gears. For instance on level roads at a speed of between 40 and 60 kph (25 and 37 mph) use the 4th gear in preference to the 3rd gear.

Accelerate gradually. Under normal driving conditions shift to 2nd gear at 10 kph (6 mph), to 3rd gear between 25 and 35 kph (15 and 21 mph) and to 4th gear between 40 and 60 kph (25 and 37 mph).

Only use the full acceleration and excellent braking effect of your car when it is absolutely necessary.

Do not pump the accelerator pedal unnecessarily. Even the small quantity of fuel additionally discharged each time the accelerator pedal is depressed results in a marked increase in the overall fuel consumption.

Do not continue to accelerate on inclines when your speed drops, shift in good time to a lower gear. There are, however, no hard and fast rules for this: If, for instance, the speed drops on an incline in 4th gear from 110 kph (68 mph) to 90 kph (55 mph) and lower, it is best to shift to the 3rd gear between 80 and 70 kph (50 and 43 mph). If you are driving at a speed of between 40 and 60 kph (25 and 37 mph) in 4th gear on a level road shift to 3rd gear right at the beginning of the incline.

Reduce your speed in good time before corners and when stopping. Do not coast downhill.

High speeds always result in increased fuel consumption. When accelerating, depress the accelerator pedal slowly and only to such an extent as is necessary to reach the desired speed. On long journeys in particular this method will prove very economical.

The most advantageous engine operating conditions result from brisk driving and correct gear shifting.

## Parking

Parking in limited spaces can be made quite simple:

Stop your car level with the car in front of the space. Turn the steering wheel sharp to the right and reverse slowly into the gap:

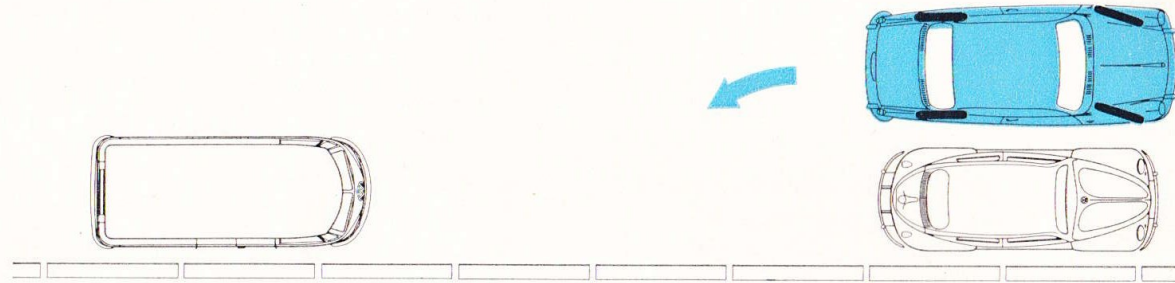

When the front bumper of your car is level with the rear bumper of the car ahead of you, turn the steering wheel fully to the left and back up further towards the curb:

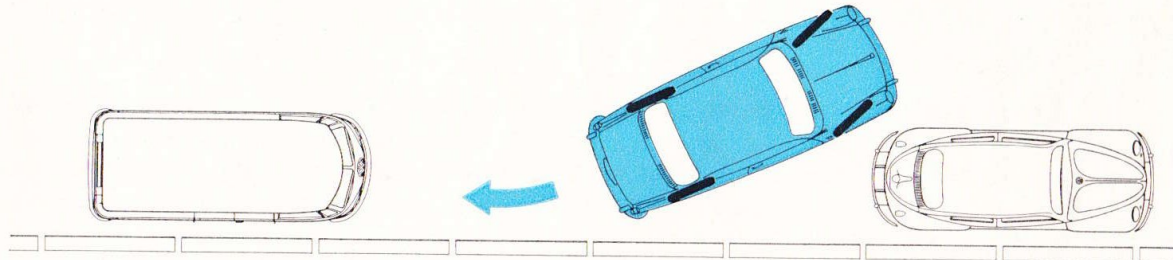

Now turn the steering wheel to the right again and pull up a little bit, until both ends of the car come as close to the curb as possible:

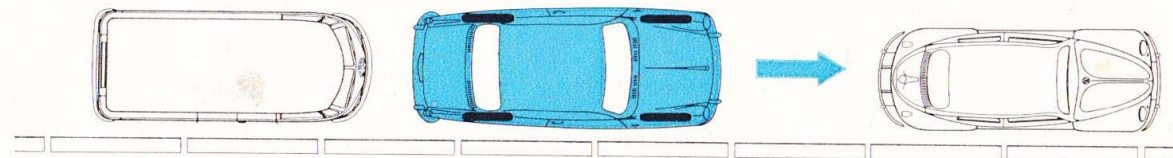

When parking on a steep slope, set the handbrake and also engage first or reverse gear. **Remove the key at the "Halt" position only when the vehicle is stationary.** This locks the steering and protects the vehicle against theft.

## Brakes

The brake responds to even the slightest foot pressure. Apply the brakes carefully and avoid locking the wheels. Locked wheels will not shorten the braking distance but may cause you to lose control over the vehicle and will affect the tires.

When driving downhill, make use of the braking effect of the engine and shift to that gear which you would use in driving uphill. The ignition must never be switched off when going downhill.

Violent braking can only be justified in an emergency. Nevertheless, it is advisable to check the full braking effect at certain intervals so that you will be familiar with the behaviour of the car and the actual braking distance.



## Cold Weather Hints

Your car has two features which you will most appreciate: Air cooling and heating. You can expose your car to bitter cold without fear. Its air-cooled engine will always be ready to start and supply warm air for the interior of the car.

### The warm air heating

can be fully regulated. The distribution of warm air can be varied to suit the wishes of the occupants by means of controllable outlets at foot level. Furthermore, when required, the flow of warm air to the windshield defrosters can be increased by restricting the entry of warm air at foot level.

The left-hand lever between the front seats turns all the heating on and off and the right-hand lever controls the heating in the rear foot well. The outlets in the front foot well can be closed with slides.

If you open a vent wing or a quarter window when the heating is on, the heater output will increase noticeably because the engine fan can then force the warm air into the interior more easily.

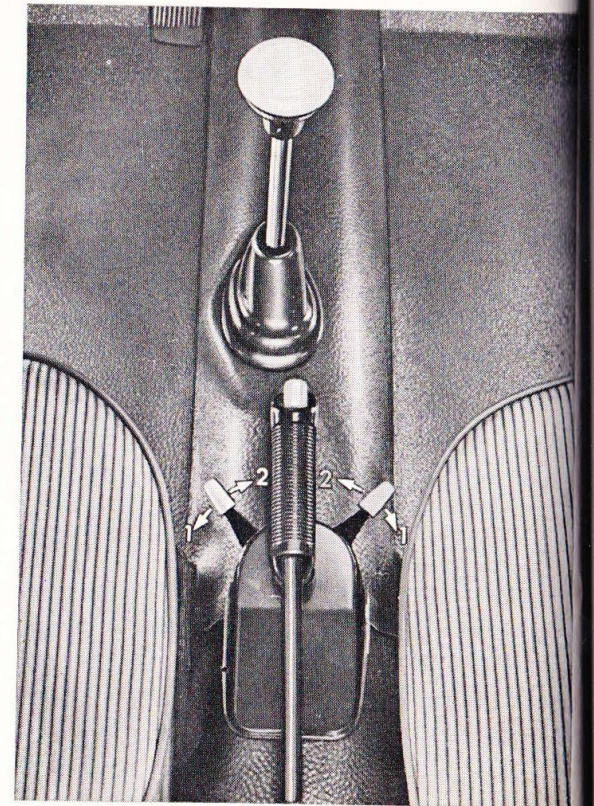

**The SAE 90 transmission oil** can generally be used all the year round. It need only be replaced by the thinner SAE 80 grade in countries with arctic climates.

**The Battery** requires particular maintenance in winter because of the increased consumption of current when starting the engine and using the lights at night. Furthermore, its efficiency decreases at low temperatures. If the car is mostly used over short distances or in city traffic, it is advisable to have the battery recharged occasionally. The connections between battery and starting motor must be kept perfectly clean.

**The Spark Plugs** should not have an excessively large gap especially in winter. The normal spark plug gap is 0.7 mm (.028"). In extremely cold weather the gap can be reduced to between 0.4 and 0.5 mm (.016" and .020") to facilitate starting.

Never attempt to influence the cooling and heating of your car in winter by covering the air intake slots below the rear window. These slots must always remain open to ensure the flow of fresh air to the carburetor and fan.

**Engine oil** SAE 30 oil will thicken at temperatures below freezing point and result in difficult starting. Change over to a thinner engine oil SAE 10 W or a multigrade oil SAE 10 W - 30 at oil changes when temperatures under freezing point are expected.

In territories where exceptionally low temperatures prevail (below  $-25^{\circ}\text{C}$  /  $-13^{\circ}\text{F}$ ), the use of SAE 5W engine oil is recommended. The oil should be changed every 1250 km (750 miles).

**The brakes** are considerably exposed to splash water and condensation which in winter is apt to freeze in the brake drums. Therefore, when parking your car, do not set the handbrake, but shift to first or to reverse gear.

**The door locks** can freeze up in winter, especially if water gets into the lock cylinders when washing the car. Do not aim the water jet directly at the locks, but instead, cover up the key holes when washing. The frozen lock can be opened by warming the key before insertion and then squirting anti-freeze into the lock cylinder straight away.

**Tires.** Worn tires are apt to cause trouble in winter. For safety's sake replace them in time.

M+S tires are available to meet the special requirements in winter. These special-tread tires are designed to give a better grip in mud and snow. They are used either on the rear wheels only or on all four wheels.

**Chains.** You will need chains only when the roads are covered with snow. Have the chains fitted in good time to the wheels if you wish to avoid loss of time and inconvenience later on. When driving on long stretches that are free from snow, the chains should be removed to avoid unnecessary wear of both chains and tires.

## Care of the Tires

Apart from the tire pressures, your driving habits also considerably affect the tire wear. Rapid acceleration, violent braking and cornering result in more excessive tire wear as compared to careful driving.

Avoid overloading the car and protect the tires from intense sunlight, fuel or oil.

The tires should be checked occasionally for foreign matter and damage. The tire tread should never be allowed to wear down to a thickness of less than 1 mm (.04") which is the absolute minimum required for safe usage. If the tires show signs of uneven wear after a considerable mileage consult your local VW dealer.

For smooth running at high speeds and long tire life, it is important to have the wheels balanced statically and dynamically. As the wheels can get out of balance owing to natural tire wear they should be balanced every 10,000 km (6,000 miles).

When mounting the tires, the red mark should be positioned at the valve.

## Changing Wheels

The spare wheel, jack and tools are found under the front hood which is opened by means of the knob under the instrument panel. On the Sedan the jack is secured by a clip near the spare wheel. On the Variant

it is in a bag in the front luggage compartment, together with the tools.

Set the hand brake and block the wheel opposite the one being removed to prevent the car shifting off the jack.

Take off the wheel cap with the removal tool and loosen the wheel bolts with the wrench and operating bar.

Insert the jack in the square tube below the sill panel.

Sedan: Push down the jack base plate until it makes contact with the ground and then jack the vehicle up until the wheel is clear of the ground by using the bar as a lever.

Variant: Place wheel bolt socket on jack and raise vehicle by cranking.

Remove wheel bolts and take off the wheel.

Raise the car until the five holes in the wheel are nearly lined up with the holes in the brake drum.

Insert one wheel bolt and tighten it to such degree as to allow the wheel to be swung round this point by hand until the remaining holes in the wheel and brake drum coincide.

Insert the other wheel bolts.

Tighten the wheel bolts at first until the countersunk heads are centered in the corresponding recesses of the wheel and then fully tighten diametrically opposite in turn.

Lower the vehicle. On the Sedan this is done by inserting the jack operating bar into the hole marked "ab" and pressing it down. After lowering the car do not remove the operating bar at once, but hold it down and pull the jack tube up so that the jack can be stowed in its place near the spare wheel. The jack on the Variant must not be put in with the spare wheel as there is a risk of the hood being damaged on closing.

Make sure that all the bolts are tight.

Install wheel cap and make sure that it is tightly seated.

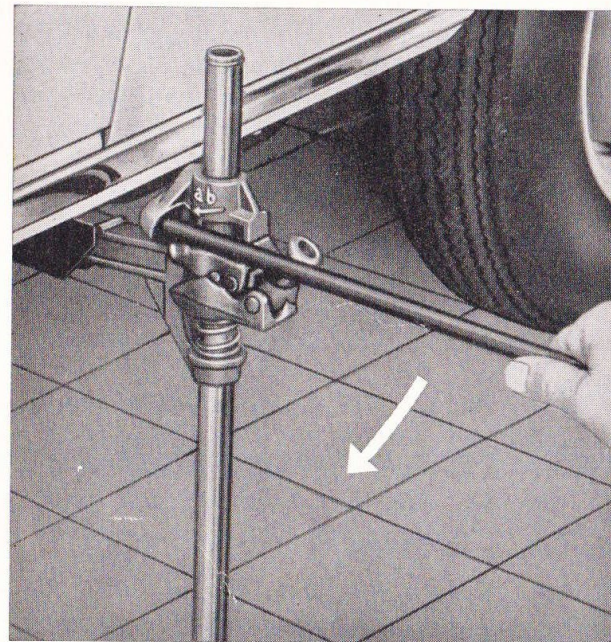
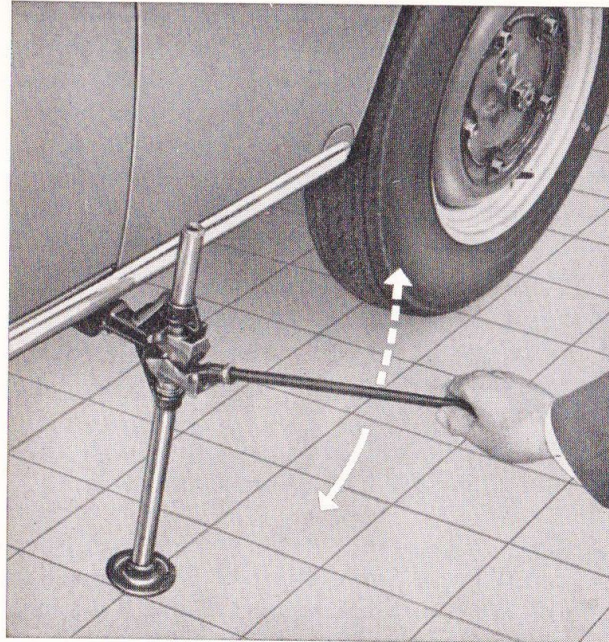

## Care of the Car

**Clean and smart appearance.** To keep your car looking smart and new should be a matter of pride to the driver or owner. It is our object to provide you with paintwork which not only looks good and has a sparkling lustre but is most durable. A chemical treatment protects the body against rust and anchors the synthetic resin enamel to the metal.

Even the best paint work requires regular care. You will realise the importance of this if you consider that the paint is exposed to sunshine, rain, dust and dirt.

**Wash** your new car frequently during the first weeks as this is good for the finish. When washing you require a soft sponge for the body, a soft brush for the wheels, a sturdy, long-handled brush for the chassis, and plenty of water.

The chassis and lower part of the body should first be flushed with water to soak off the dirt, and afterwards a brush should be used.

Spray the exterior finish of body and wheels evenly with water until dirt is soaked off. Do not allow a powerful jet of water to hit the painted surface. Using plenty of clear water, remove dirt with a sponge. Clean the sponge at short intervals to avoid scratching the paintwork.

There are many proved auto soaps and detergents available which greatly facilitate this job. Do not buy just any product, let your VW dealer advise you. It is of utmost importance to rinse the body thoroughly with water to ensure that no traces of the detergent remain on the body. After washing, dry off with a clean chamois to prevent water spots from forming.

**Preservation (Waxing)** should be carried out for the first time after approximately 8 to 10 weeks and afterwards, if possible, at regular intervals of between 6 and 8 weeks. Waxing means to restore to the finish certain substances it has lost by exposure to the weather. At the same time a protective water-repellent coat of wax is applied to the body.

The "Genuine VW Preservative" (L 190) was specially produced for the Volkswagen and is obtainable from every VW dealer. After washing and drying the car thoroughly, apply the preservative with a soft cloth. Let it dry for approximately 20 minutes and then rub it down with polishing cotton or a soft polishing cloth until iridescent colours can no longer be seen when you are standing at an angle to the polished area.

Do not forget to wax the car after each detergent washing as the intensive cleansing properties of the chemical detergent will dissolve the protective film of wax.

**Polishing.** You should polish your car only if its appearance has been affected as a result of insufficient care, or if the application of the preservative no longer restores the original lustre. Avoid the use of abrasives or chemically harmful products.

A special polish for the synthetic-resin enamel finish is also available from your Volkswagen dealer under the designation "Genuine VW Polishing Fluid" (L 170). Prior to applying the polish, the car must be washed and dried carefully. The polish should be applied with a soft clean cloth or polishing cotton — use a straight horizontal or vertical motion rather than a circular motion. After rubbing for some time you will notice a slight resistance, which indicates that the ingredients of the polish have settled in the finish and that the solvent has evaporated. Now take clean polishing cotton and rub the body down until the high polish is restored.

To prevent the polishing fluid from drying off prematurely, do not apply it on too large an area of the body at a time. A subsequent application of the preservative and your efforts will be rewarded with a long-lasting shine.

---

Never wash, wax or polish the car in sunlight.

---

**Tar spots.** Tar splashes have a tendency to corrode the finish within a short time and should be removed as soon as possible with Genuine VW Preservative.

On the road you usually have nothing at your disposal but fuel. Kerosene or turpentine may also be used. After this, the treated spots should be washed with a mild, luke warm detergent solution, and rinsed, in order to remove traces of the cleansing agent.

**Insects** are caught, especially in hot weather, on the front of the car and on the windshield. Insects should not be allowed to remain on the paint finish for long and should be removed with water and a sponge. Once baked on they can only be removed with luke warm detergent solution.

### **Parking under Trees**

Vehicles which are parked under trees for long periods in summer are often found to be covered with spots. These spots can be removed fairly easily with luke warm detergent solution if the treatment is not delayed too long. It is advisable to apply a coat of preservative afterwards.

**Chrome Parts** should be treated with "Genuine VW Chrome Cleaner Chromlin" when dry. Apply Chromlin thinly and allow to dry for 10 minutes before polishing with a dry cloth.

**Cloth upholstery.** If a vacuum cleaner is not available, the upholstery should be cleaned thoroughly with a brush or whisk broom. Stains can generally be removed with luke warm soap suds. Grease and oil stains are removed with cleaning paste or cleaning fluid. Do not pour the cleaning fluid directly on the upholstery as otherwise rings will form. Moisten a clean, uncoloured cloth with the fluid and rub with a circular motion, starting outside the spot and working inwards.

**Leatherette** can best be cleaned with a soft cloth or soft brush. If very dirty, a luke warm soap solution or a dry foam cleaner can be used.

Seats and backrests upholstered entirely with leatherette must only be cleaned with a dry foam cleaner. The wearing surfaces are made of a special leatherette which is permeable to air and liquid cleaners would immediately penetrate into the textile backing.

Grease and paint spots should be wiped off before they dry up. Soaked-in spots can be removed by rubbing carefully with a cloth moistened with benzine or methylated spirits. Spots caused by shoe polish can be removed with turpentine. Use these agents carefully and sparingly as otherwise they tend to dissolve the dust-repellent finish of the leatherette. Solvents such as trichlorethylene or paint thinner must not be used for cleaning. After cleaning, the leatherette should be dried thoroughly with a soft cloth. So-called preservatives are not suitable for leatherette because they do not soak into the material and merely collect dust and soil clothing.

**Cleaning glass.** Windows can be cleaned by washing with water and wiping dry with a soft clean linen cloth. To facilitate this task the arms of the windshield wipers can be tilted forward. Use alcohol or household ammonia and luke warm water to clean exceptionally dirty windows.

**Door and window weatherstrips.** It is important to keep the rubber parts undamaged and supple to ensure perfect sealing. To retain the original flexibility of the rubber, these parts should be coated occasionally with talcum powder.

**Airing the interior.** If the car is left in your garage for a long period, it must be aired regularly. Permit air to circulate freely by opening the doors and lowering the windows to prevent the formation of mould and damp stains.

## Lubrication Service

To lubricate correctly means to lubricate carefully and at the prescribed intervals. Therefore, do not omit to have the lubrication service carried out at regular intervals. A lubrication chart can be found on page 61 indicating the correct mileages at which to lubricate.

The Service Booklet makes it possible for you to have your car lubricated at our authorized workshops by skilled personnel, at lowest cost and in a minimum of time. You really cannot afford to miss this opportunity.

### Engine

Regular oil changes are necessary even if the very best branded oils are used. Dirty oil in your engine simply means increased wear and a shorter service life.

The oil is drained, when warm, by removing the plug in the oil strainer bottom plate. Flushing of the engine is unnecessary. However, the oil strainer must be removed and cleaned at every oil change. The two gaskets must be renewed each time. The engine is refilled with 2.5 liters of HD oil (5.3 US pints/4.4 Imp. pints).

Draining the engine oil.

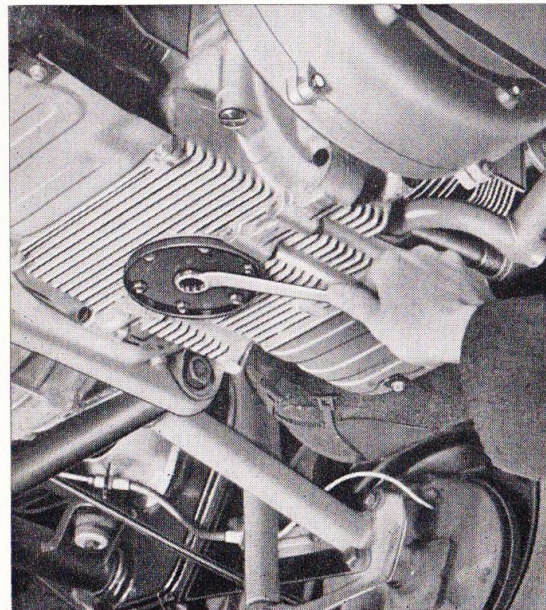

Cleaning the oil strainer.

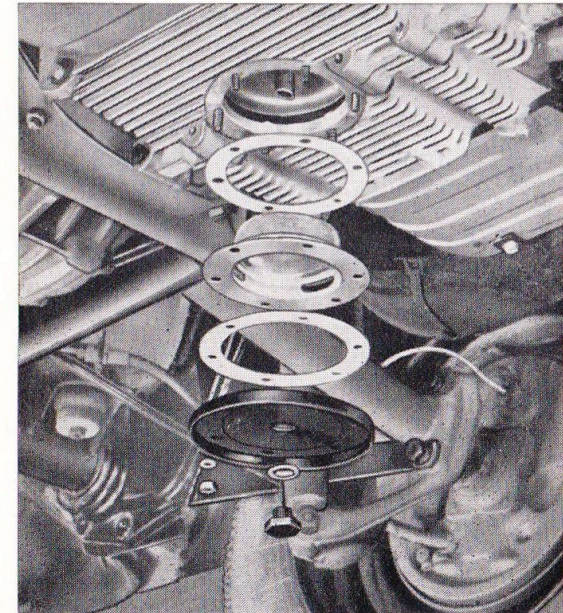



It is superfluous and uneconomical under normal operating conditions to change the oil at shorter intervals than every 5,000 km (3,000 miles). We recommend oil changes at more frequent periods, i. e. at intervals of 2,500 km (1,500 miles) only if you do not drive much in winter and in doing so mostly cover short distances in city traffic.

### **Types of lubricant**

HD oils are prescribed for the engine lubrication. HD oil is an oil having proved oxidation stability, bearing corrosion preventive properties and detergent-dispersant characteristics which tend to hold in suspension foreign contaminants which would normally deposit on engine parts. These foreign contaminants will drain out with the oil at the periodical oil changes. The detergent properties of HD oil will make the fresh oil darker after a short time of operation. This is quite natural and there is no reason whatsoever to change the oil earlier than called for in the Lubrication Chart.

### **Some more Information on Oils**

The quality of branded oils is such that the choice is left to your discretion. In cases of doubt, your authorized VW dealer will be glad to assist you. We recommend that you select "your" oil after the first 500 km (300 miles) and stick to it at all future oil changes.

Viscosity of the lubricant is an indication of its resistance to flow at a given temperature. The SAE numbers for instance SAE 30, SAE 10 W etc. classify lubricants in terms of viscosity. The outer temperature is decisive when selecting the viscosity.

**SAE 30** is suitable for temperatures above 0° C (32° F).

**SAE 10 W** should always be used in the cold season if the temperature is expected to fall below 0° C (32° F) by the next oil change.

**SAE 5 W** is for use in arctic climates below —25° C (—13° F) only.

32 **SAE 10 W - 30** is a multigrade oil and can be used in summer and winter.

Temporary deviations in the temperatures for the various viscosity grades are of no importance. It is permissible to mix oils of different viscosity grades when it is necessary to add oil between the oil changes, and the outer temperature no longer corresponds to the viscosity grade of the oil in the engine. It is, however, essential that the same brand of oil be used.

In some countries the API classification is applied (API = American Petroleum Institute). According to this classification, the HD oils suitable for the VW engine are referred to as "For Service MS".

No additives of any kind should be mixed with HD oils.

### Transmission

The transmission and differential gears are combined in the transmission case and both lubricated with Hypoid oil. At oil changes — at 500 km (300 miles), 5,000 km (3,000 miles) and then again at 50,000 km (30,000 miles) — the old oil is drained by removing both the magnetic drain plugs while the oil is at operating temperature. The magnetic oil drain plugs should be cleaned thoroughly and the transmission then filled with 2.5 litres (5.3 US pints/4.4 Imp. pints) of branded Hypoid oil.

Additives should not be used with Hypoid oils.

Draining the transmission oil.

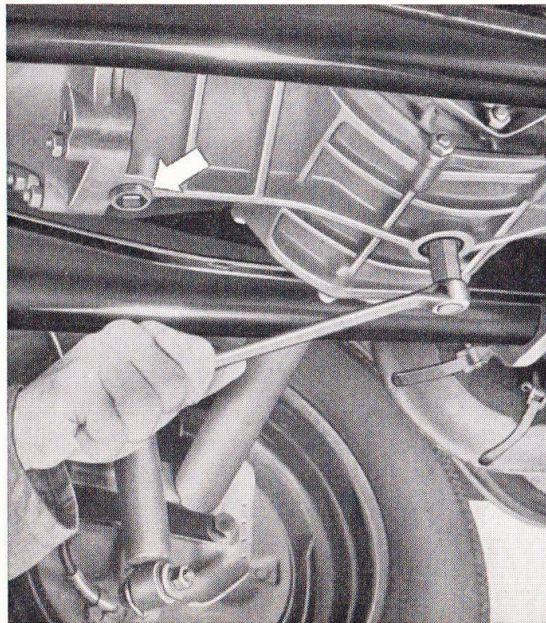

Filling with transmission oil.

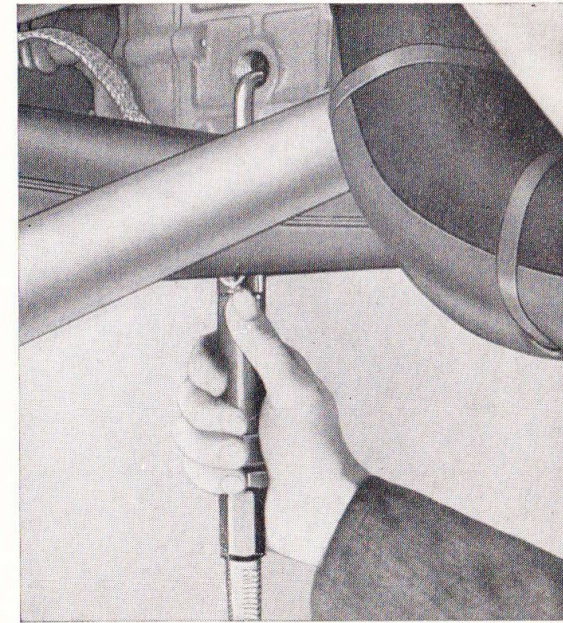

### Steering Gear

The oil level in the steering gear can be checked after removing the spare wheel well. The steering gear should be lubricated exclusively with Hypoid oil and under no circumstances with grease or other oils. The oil level should be approximately up to the lower edge of the filler plug hole.

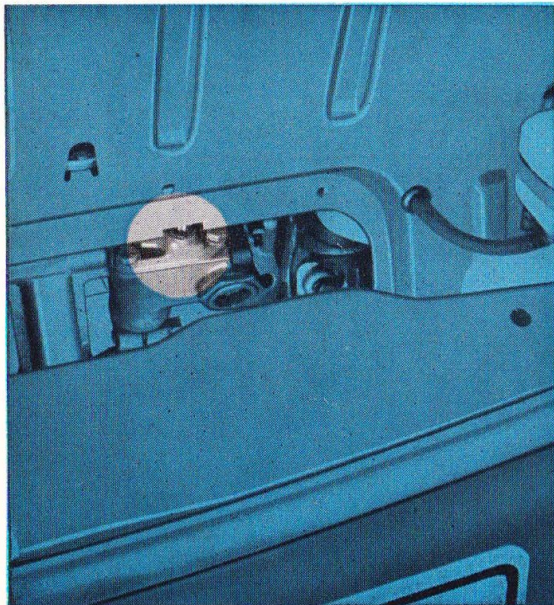

### Chassis

**Proper lubrication of the front axle bearing points can best be ensured by raising the front axle so that the weight is taken off the wheels.**

The front axle has four grease fittings which must be lubricated every 5,000 km (3,000 miles).

Prior to lubrication, the grease fittings should be cleaned thoroughly with a cloth to prevent dirt from being forced into the bearings.

The dust seals of the maintenance-free ball joints must be checked for damage and se-



curity at every lubrication service. Damaged seals should be replaced immediately if possible.

Not even the smallest quantity of grease and oil should come into contact with the tires and brake hoses. Even small quantities should be wiped off immediately.

If your car is driven mainly over rough roads, we recommend that you lubricate the front axle at more frequent intervals, i. e. every 2,500 km (1,500 miles).

If you drive less than 10,000 km (6,000 miles) in the year, we suggest that these grease fittings be lubricated every 2,500 km (1,500 miles).

Annually at the beginning of the cold season the cables for the accelerator, clutch and heating as well as the clutch cable adjusting nut should be checked and, if necessary, cleaned and lubricated.

### **The Front Wheel Bearings**

are provided with sufficient grease at the factory. The caps on the front wheels hubs must be free from grease.

Every 50,000 km (30,000 miles) the bearings should be carefully cleaned and packed with the grease prescribed under "Lubricants".

The brake drums must be removed for this purpose. Finally the front wheel bearings

must be adjusted. In order to avoid damage to the bearings, this operation should, if possible, be carried out in a VW workshop only.

### **Doors and Hoods**

The door hinges should be oiled at every lubrication service or, better still, once a month.

The door lock cylinders are lubricated with graphite. It is sufficient to dip the key into the graphite and to move it back and forth several times in the lock.

The door lock striker plates should be very lightly greased.

The hood hinges are oiled, the hood locks lightly greased.

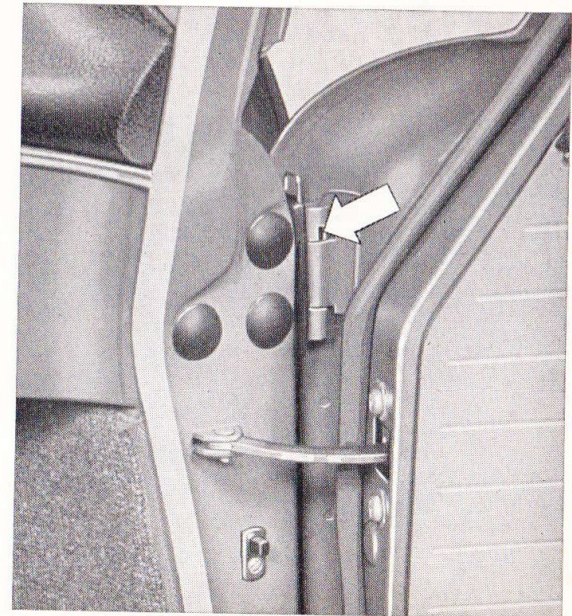

## Maintenance Service

The Volkswagen Service Organisation has made available for you an extensive network of authorised VW workshop staffed with well trained and experienced personnel, and equipped with all the special tools required for servicing your car. If ever you should need service when touring and away from home, look for the well-known VW Service Sign. Here you will receive prompt and expert assistance.

In case you can't get to an authorised VW workshop in time, we are giving you some information which, if needed, will help you to carry out normal maintenance work. However, it is important that repair jobs which are beyond your capacity should be performed by the nearest VW workshop. Your car is then in capable hands. This will save you time, inconvenience, and money.

### Checking the V-belt

The belt should be checked at regular intervals for tension and wear. When pressed with the thumb it should yield approximately 1.5 cm (.6") and should not show signs of excessive wear.

The intake housing cover is removed when adjusting or replacing the belt. Now loosen the nut on the generator pulley with a 21 and 27 mm wrench and remove the rear half of the generator pulley. The belt tension is adjusted by removing or inserting spacer washers between the two pulley halves. Removing spacer washers increases the tension and inserting washers reduces it. The belt should not be too slack, nor should it be too tight.

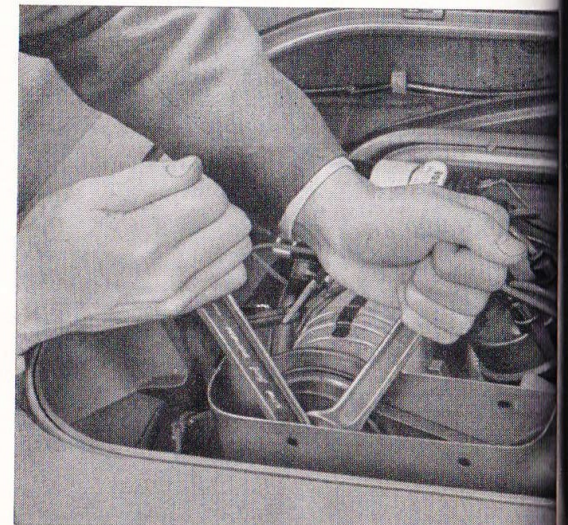

### Checking Air Cleaner

The oil bath air cleaner should be checked every 5,000 km (3,000 miles).

All the dust present in the air drawn in by the engine is retained by the filter in the upper part of the air cleaner and washed out when the vehicle is in motion by the oil in the lower part of the cleaner. In time, this causes a layer of sludge to form at the bottom of lower part. If the cleaner check reveals that there is only 4—5 mm (.16"—.2") of oil above the sludge layer, the lower part should be carefully cleaned and filled with fresh oil. The top part does not need cleaning. However, if the filter insert has become so dirty due to delayed cleaning of the lower part or oil shortage that the air inlet holes on the underside are partly blocked, the encrusted dirt should be removed, preferably with a chip of wood.

A dirty filter insert not only reduces the engine output, it can also cause premature wear in the engine. If the local conditions are such that the vehicle is frequently driven over very dusty roads it is advisable to clean the air cleaner more often.

The warm air control flap should be checked each time for freedom of movement. This flap regulates the flow of pre-heated air to the carburetor in conjunction with the speed of the engine.

### Servicing Air Cleaner

Loosen clip on air cleaner intake elbow and pull bellows off elbow.

Pull crankcase breather hose off air cleaner. Remove clip at carburetor elbow.

Remove air cleaner securing screw completely.

Take air cleaner off and disassemble. Never lay the upper part down with the filter element upwards.

Clean the lower part thoroughly and fill to the mark with fresh SAE 20 engine oil.

When installing the air cleaner, ensure that the carburetor elbow fits properly and that the bellows fits tightly on the air cleaner intake elbow.

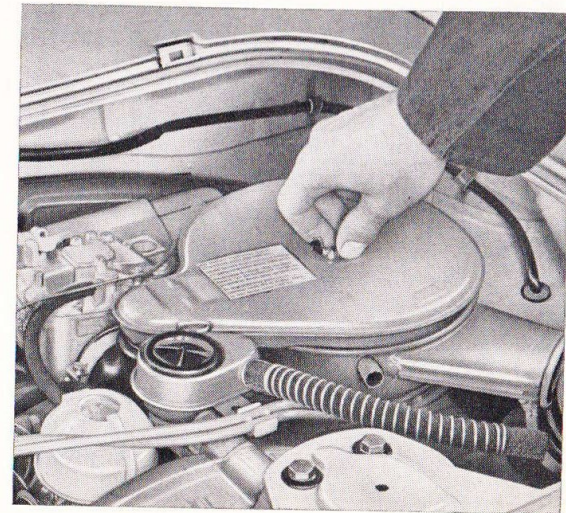

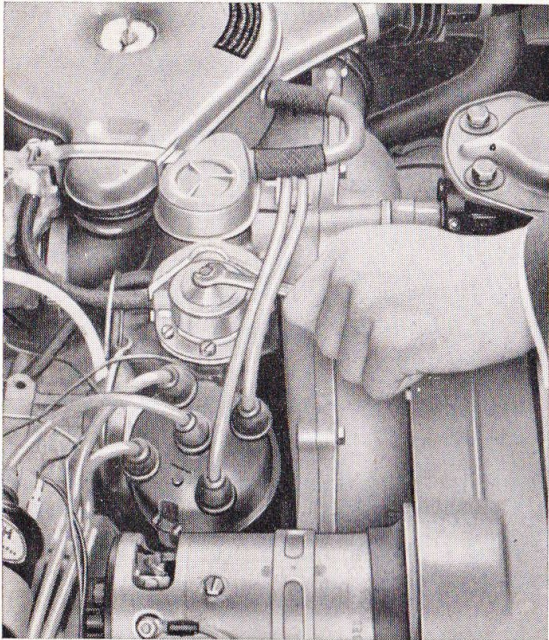

### **Cleaning the fuel pump filter**

The fuel pump filter prevents foreign matter and water from entering the carburetor. It should be removed and cleaned at the prescribed intervals.

Install clip on fuel hose in engine compartment.

Remove lock ring for the fuel pump protection cap.

Remove left half of the protection cap.

Remove retaining screw and take off cover.

Take out filter and wash out in benzine.

When installing the filter do not omit the gasket for the cover.

### **Ignition timing**

Particular attention must be paid to correct ignition timing. In many cases poor performance, high fuel consumption and even damage to the engine can be the result of incorrect ignition setting. The ignition must not be advanced arbitrarily, not even if premium fuels are used.

Before setting the ignition timing, the breaker contact point gap must be checked. With the breaker arm fully lifted the clearance should be 0.4 mm (0.16"). The initial spark advance must be set to 10° before top dead centre.

The ignition timing must only be set with the engine cold or when it is slightly warm.

### **Cleaning Contact Points**

The contact points must be smooth and make even contact with each other. Dirty contacts should be cleaned and, if pitted, smoothed with a contact file. Whilst doing this, the contact points are pressed lightly together. Afterwards the ignition distributor should be blown out carefully with air. If the points are badly burnt they must be replaced.

### Lubricating Ignition Distributor

The breaker arm fiber block in the ignition distributor should always be provided with some lithium grease. Every 5,000 km (3,000 miles) check whether this location must be cleaned and provided with new grease. Only a very small amount of grease should be used and none of it must come in contact with the breaker points as otherwise the ignition will be affected.

Every 5,000 km (3,000 miles), one drop of oil must be applied to the breaker base plate felt ring.

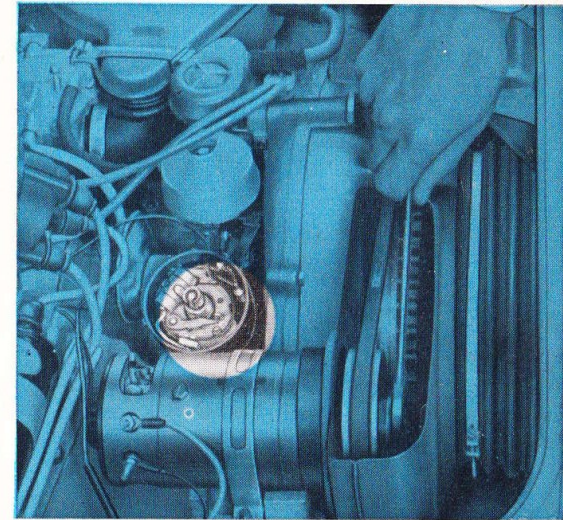

### Adjusting Contact Points

Remove distributor cap and rotor.

Remove air intake housing cover and crank the engine by means of the generator until the contact arm rests on the highest point of the cam lobe.

Loosen the breaker point locking screw.

Insert a screwdriver between the two lugs on the contact plate and the slot in the point carrier and adjust the gap to 0.4 mm (.016").

Tighten locking screw and install rotor.

After the contact points have been adjusted, the ignition timing must be reset.

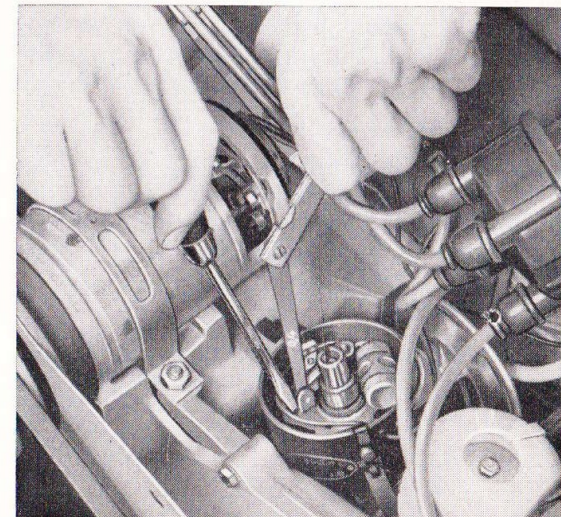



## Setting the ignition timing

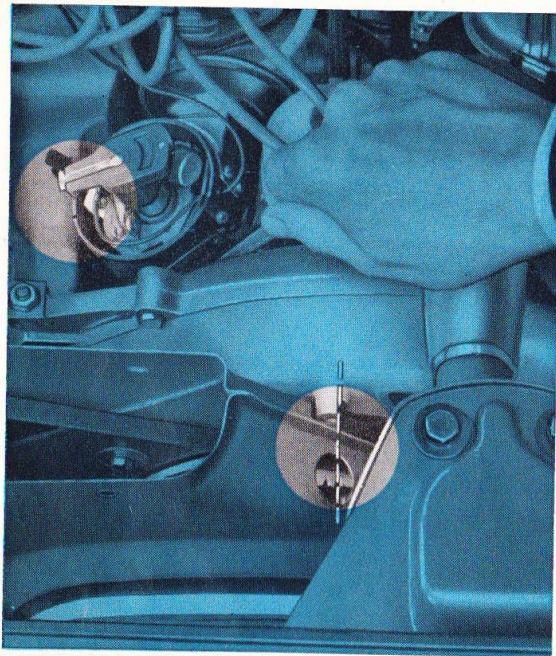

Crank the engine clockwise until the center mark on the crankshaft pulley lines up with the adjusting surface on the fan housing and the distributor rotor arm is in line with the number 1 cylinder mark on rim of distributor.

Loosen clamp screw on distributor retainer.

Connect a 6 Volt test lamp to terminal 1 of the ignition coil and to ground.

Switch on ignition.

Rotate the distributor clockwise until the contact points are closed and then slowly

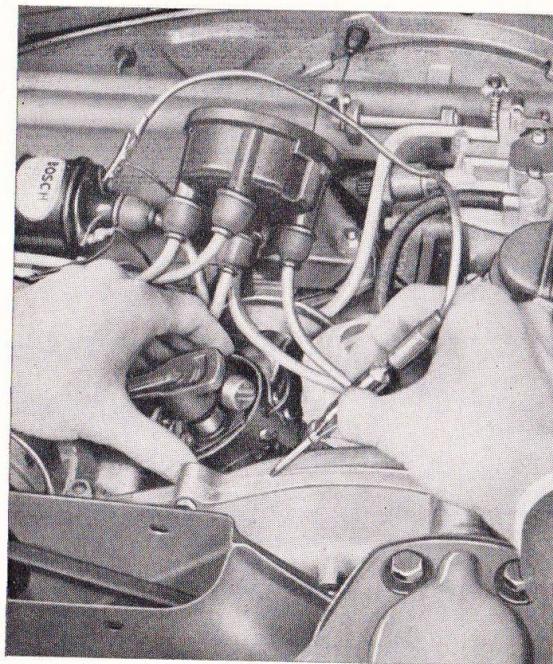

anti-clockwise until the contact points just start to open and the test lamp comes on.

Tighten the clamping screw of distributor retainer.

Install distributor cap.

The ignition is correctly set if on cranking the engine slowly clockwise, the test lamp comes on when the center mark on the crankshaft pulley is in line with the adjusting surface on the fan housing. Beforehand, the engine should be turned back anti-clockwise approximately a quarter of a revolution to take up the play in the distributor drive.

## Checking the Spark Plugs

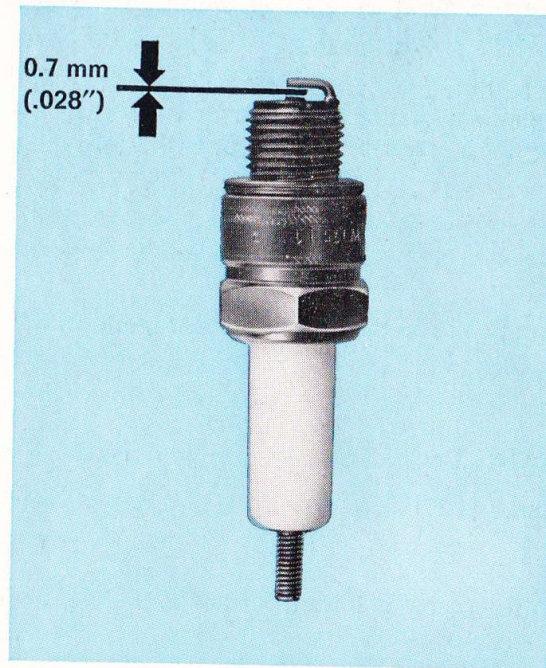
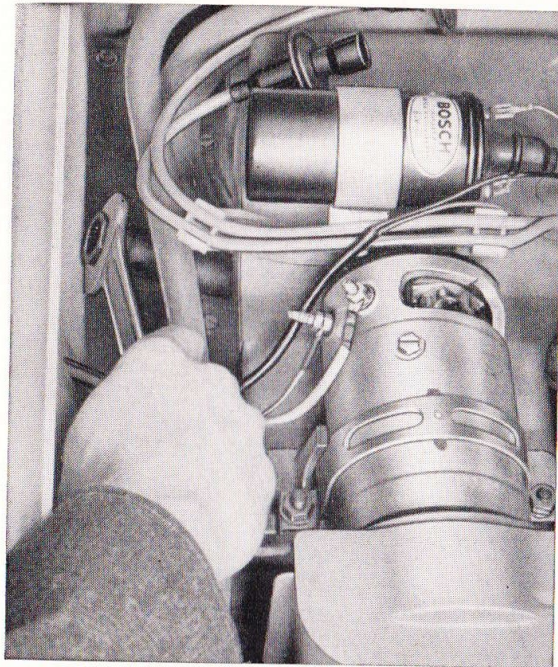

The appearance of the electrodes and insulation gives valuable information on the adjustment and condition of the engine:

- medium grey — correct carburetor adjustment and proper performance of spark plug
- black — mixture too rich
- light grey — mixture too lean
- oiled up — failure of spark plug or piston ring blow-by

The spark plugs have an average service life of approximately 15,000 km (9,000 miles) and should, therefore, be replaced in time. To prevent any breakdowns in the ignition

system, the spark plugs should be removed every 5,000 km (3,000 miles) and checked. Deposits can easily be removed with a brush and a chip of wood. Moreover, the insulator should be clean and dry on the outside in order to avoid short circuit and tracking. If necessary, adjust the spark plug gap which should be 0.7 mm (.028").

Do not omit the gasket when screwing in the spark plug. Do not overtighten the spark plugs.

## Checking Compression

The compression of each cylinder is checked with the engine at operating temperature. All the four spark plugs and air cleaner must be removed when checking the compression. Fully depress the accelerator pedal and operate the starter motor.

Compression	kg/cm <sup>2</sup> (psi.)
good	9—10 (128—142)
satisfactory	7—9 (100—128)
poor	below 7 (100)

## Adjusting the Valves

The valves must only be adjusted when the engine is cold or slightly warm. The valve clearance for both intake and exhaust valves is 0.30 mm (.012").

When adjusting, both valves must be closed, i. e. the piston of the corresponding cylinder must be at T.D.C. of the compression stroke. The arrangement of the cylinders can be seen by the numbers 1 to 4 on the engine cover plates. Valve adjustment is carried out in the following sequence: cylinders 1, 2, 3, 4.

Remove intake housing cover.

Remove distributor cap.

Turn the engine from the generator until the rotor arm points to the No. 1 cylinder mark on the rim of the distributor.

Remove cylinder head cover.

Loosen the adjusting screw lock nuts for the valves of No. 1 cylinder.

Adjust valve clearance with a feeler gauge to 0.30 mm (.012").

Hold the adjusting screws and tighten the lock nuts.

To adjust the valves for cylinders No. 2, 3 and 4, the engine is turned further anti-clockwise until the rotor arm is 90° offset each time.

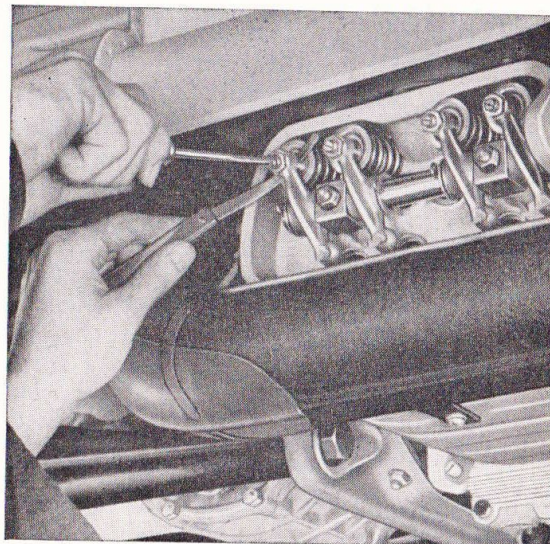
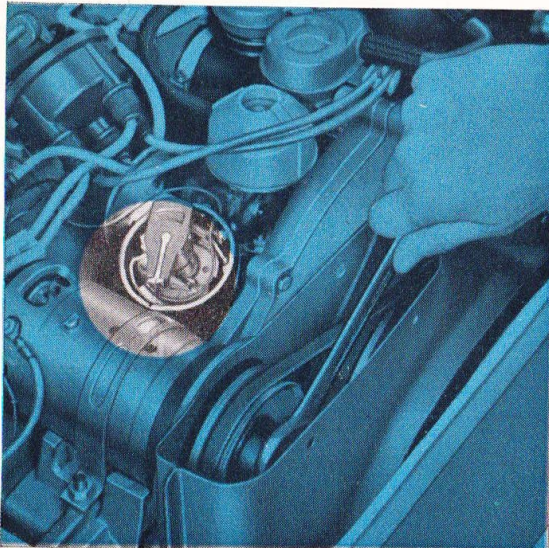

## Adjusting the Carburetor

Each carburetor is checked at the factory and adjusted to the engine. Special knowledge and experience is required for checking and adjusting the carburetor with automatic choke and for carrying out repairs on the acceleration pump. For this reason, these operations should only be carried out by a VW workshop. Do not alter the adjustment by replacing the jets by other than the prescribed sizes. This would be detrimental under normal operating conditions and is not permissible.

Only the idling speed may require occasional readjustment. The adjustment must be carried out when the engine is at operating temperature:

Turn the idling adjusting screw (1) until an idling speed of about 550 rpm has been attained.

Turn the volume control screw (2) clockwise until the engine speed begins to drop. Then give it a  $\frac{1}{4}$  to  $\frac{1}{3}$  turn in anti-clockwise direction.

Re-adjust the idling adjusting screw (1).

The adjustment is correct if the engine does not stall when the throttle is either suddenly opened or shut.

Poor idling may also be the result of damaged gaskets, loose intake manifold flanges, faulty ignition or leaky valves.

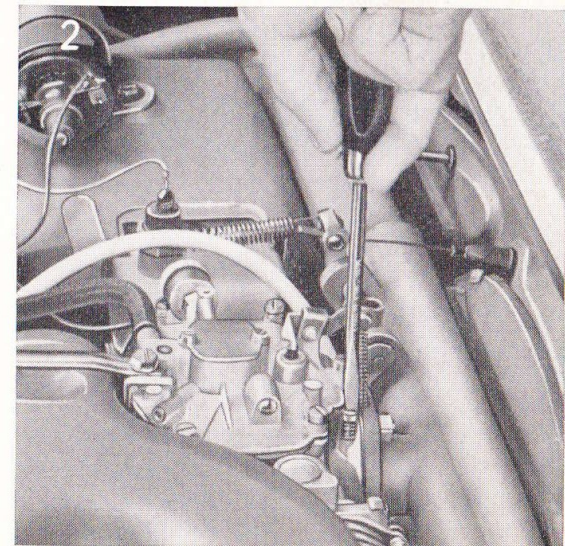
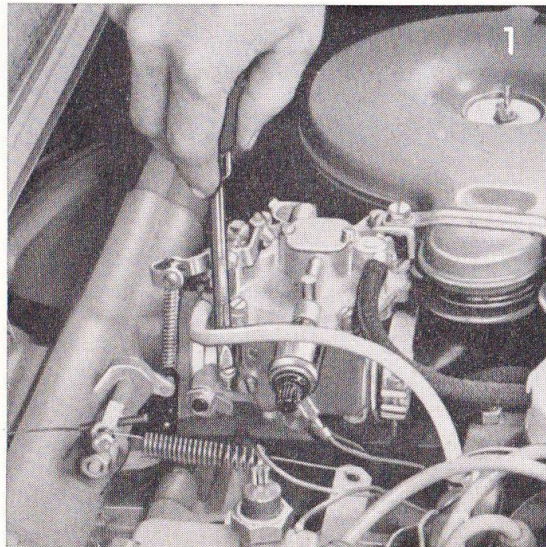

### Checking Clutch Pedal Free-Play

Easy gear shifting and complete transmission of engine performance to gears and wheels can only be guaranteed if the clutch is adjusted as specified.

Measured at the clutch pedal, this free-play should be between 10 and 20 mm / .4 and .8 in. (a). The clearance is adjusted by an adjusting nut on the cable end.

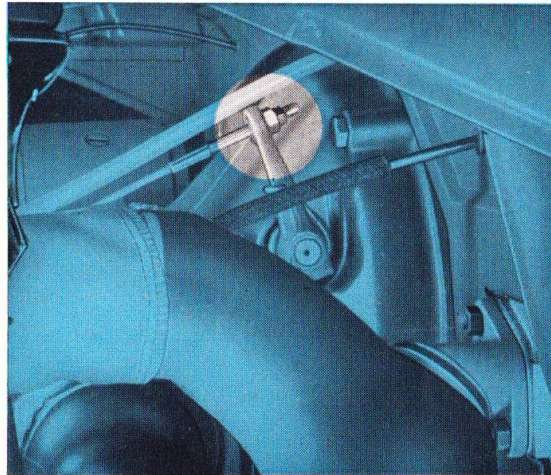
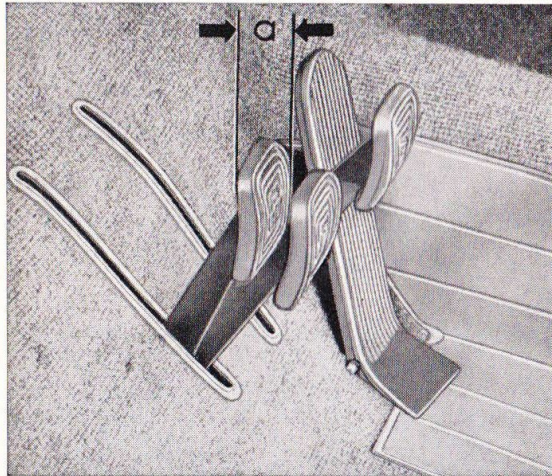

Release lock nut on the threaded cable end. Adjust free-play by turning the nut.

Depress clutch pedal several times and re-check pedal free-play.

Hold adjusting nut and tighten lock nut.

Lubricate bearing point between operating lever and adjusting nut with universal grease.

### Adjusting Front Wheel Bearings

Raise front of car.

Bend up lock plates and loosen nuts. The nuts of the left front wheel have left-hand threads.

Remove outer nut and insert a new lock plate.

Tighten inner nut until the thrust washer between bearing and nut can be moved

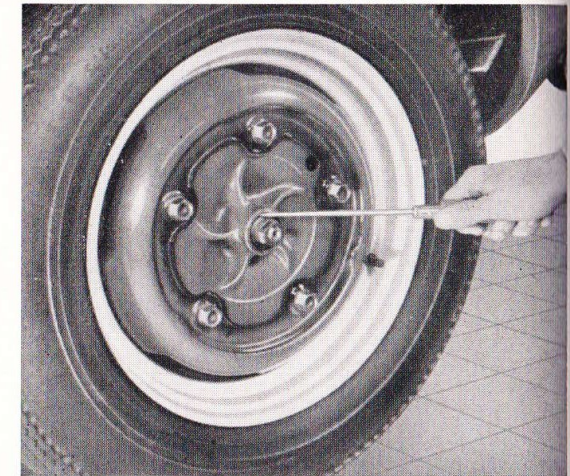

easily but without noticeable play with a screwdriver when the lock nut is fully tightened.

Bend up the lock plate alternately.

Adjustment operations on the front wheel bearings should, if possible, be carried out in a VW workshop only. Incorrect adjustment of the bearings can cause severe damage in a short time.

### Checking Play of Upper Torsion Arms

The upper torsion arms of the front axle are connected by the stabilizer and normally have hardly any noticeable axial play in their bearings. As result of wear in the course of time, this play will increase and must, therefore, be checked at the prescribed intervals every 5,000 km (3,000 miles).

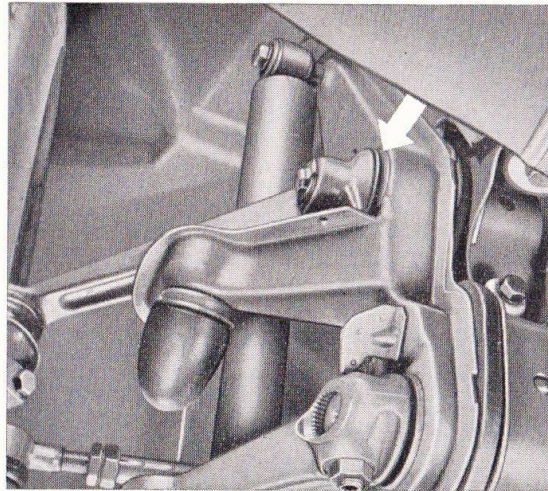

To check the play, rock one wheel and observe the torsion arms. If play is noticed at the upper torsion arms, they must be re-adjusted. This operation should be left to a VW workshop, as the camber and the toe-in of the front wheels have to be corrected afterwards. These operations require special experience and measuring devices which will be found in every workshop.

### The Camber and Toe-in of the Front Wheels

can only be reliably checked in a workshop. When the car is unladen, the camber should be  $1^{\circ} 20' \pm 10'$ , the toe-in 4 to 6 mm (.16" to .24"). Deviations from these values will have a detrimental effect on roadholding and tire wear.

### Checking the Steering

The steering must be free of excessive play in the straight ahead position. Moreover, the wheels must self-center after cornering.

To check the steering move the steering wheel to and fro until resistance is felt.

The adjustment is correct if the to and fro movement does not exceed 25 mm/1", measured at steering wheel rim.

Adjustments to the steering require special experience as well as special tools, and these operations should be carried out in a VW workshop only.

## Checking and Adjusting Brakes

As a result of natural wear, the clearance between brake shoes and drum will increase during the course of time. If the foot brake pedal travel becomes excessive, the brakes must be relined or re-adjusted.

The brake lining wear must be checked through the inspection hole in the brake drums every 5,000 km (3,000 miles). The brake lining thickness must not be less than 2.5 mm (.1"). Moreover, check the brake system for damage, leaks and corrosion. Damaged brake lines must be replaced immediately.

Spongy brake pedal travel indicates the presence of air in the system. Before bleeding the brakes, check the brake fluid level in the reservoir beside the spare wheel. The

reservoir should be at least three quarters full. Only use Genuine VW Brake Fluid or Lockheed Brake Fluid when topping up.

Handle the brake fluid carefully. It may damage the paint work severely.

## Adjusting the Foot Brake

The brake shoes are adjusted individually on all four wheels. Before and after adjustment completely depress the brake pedal several times to allow the brake shoes to centralize in the drums. When adjusting the rear brakes, the hand brake must be released.

Remove wheel cap.

Jack up a wheel and turn it until the hole in the brake drums is in line with one of the two adjusting nuts.

Turn the adjusting nut with a screwdriver in the direction indicated by the arrow until a slight drag is noted when wheel is turned by hand.

Repeat procedure on the other adjusting nut. Note that the two nuts turn in opposite direction.

Back off the adjusting nuts 3 to 4 teeth until the wheel rotates freely.

Install wheel cap and make sure that it is correctly seated.

Repeat the above operations on the other wheels.

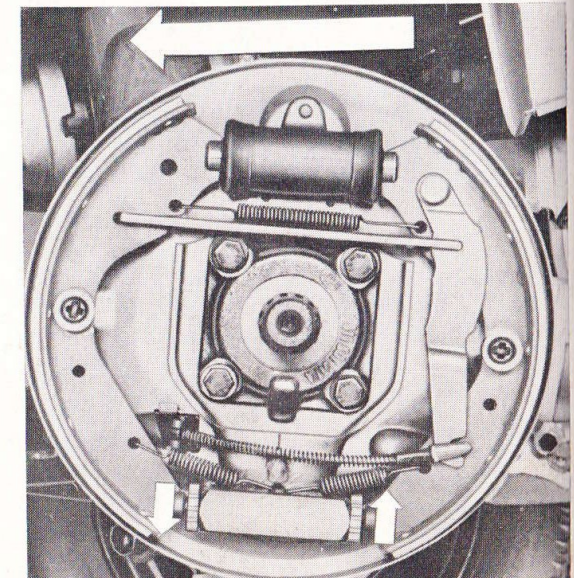
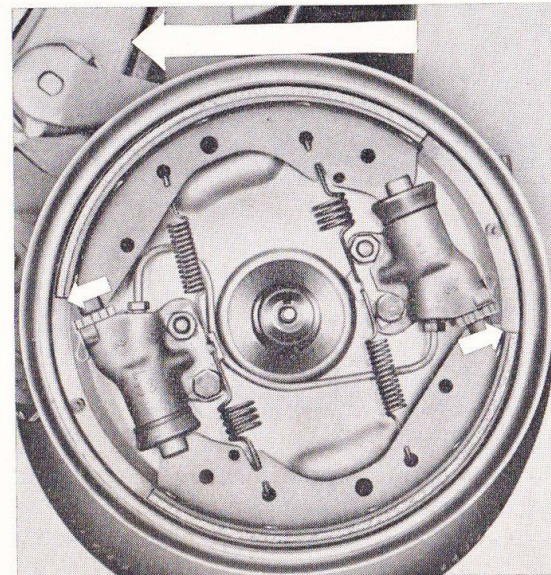
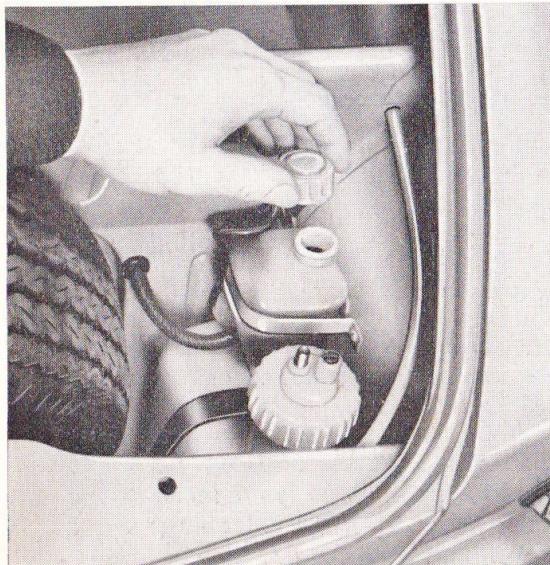

## Bleeding the Brakes

When bleeding the brakes, always begin with the wheel which is farthest away from the master brake cylinder. The sequence for cars with left-hand drive is as follows: Right and left rear wheels, then the right front and finally the left front wheel.

Remove rubber cap of the bleeder valve and attach bleeder hose.

Submerge the free end of the hose in a glass container partially filled with brake fluid. The end of the drain hose should, if possible, be above the level of the bleeder valve.

Slacken the bleeder valve between  $\frac{1}{2}$  and 1 turn using a 7 mm wrench (rear) and 11 mm (front).

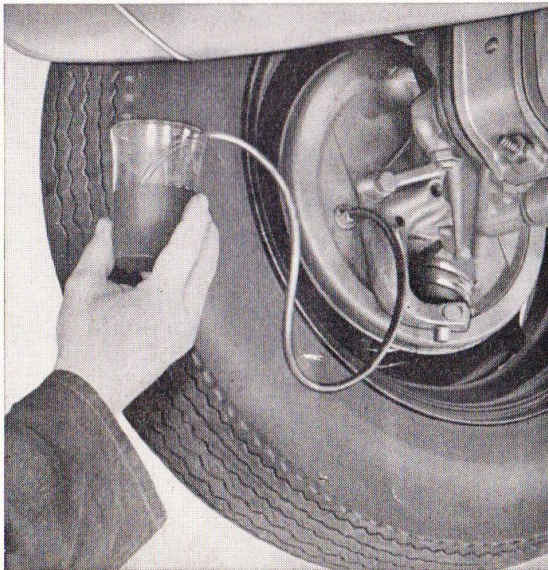

Pump the brake pedal several times until the air bubbles cease to appear.

Keep the brake pedal in the fully depressed position until the bleeder valve is closed.

Remove the bleeder hose and replace rubber cap.

Repeat the above operations on the other wheels. Make sure that the brake fluid level in the reservoir is sufficient to ensure that air is not drawn in. After bleeding the complete system, check the brake fluid level and top up if necessary.

## Adjusting Hand Brake

The hand brake is adjusted at the hand brake lever:

Raise both rear wheels.

Slide back rubber ring and fold back hand brake lever rubber boot.

Back off lock nuts and tighten the adjusting nuts until the rear wheels are just free to turn when the hand brake is released.

Pull up the hand brake lever by two notches and make sure both the rear wheels have the same braking effect. At the fourth notch it should be impossible to turn the wheels by hand.

Lock the adjusting nuts and slide the rubber ring over the hand brake lever boot.

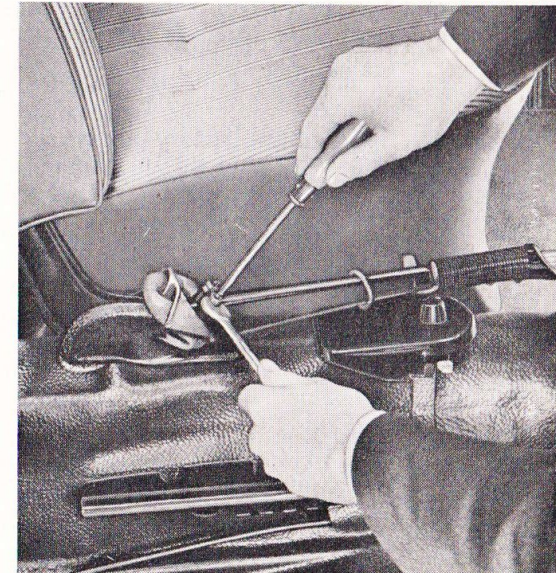



## Checking the Battery

Ready starting of the engine depends upon the condition of the battery. It should, therefore, be checked and maintained regularly. The battery cover can be removed by raising the rear seat and opening the battery snap fastener.

The acid level must always be slightly above the plates. The acid level has to be adjusted in accordance with the acid level mark. Depending on the type of battery, either the lower edge of the insert or the bar above the plates must just be covered. Losses by evaporation can be replenished by adding distilled water. Do not add acid unless some of the electrolyte has been spilled. The acid can boil over and cause damage. For this reason exercise care when topping up.

The battery should be checked with a cell tester. This is a voltmeter in parallel with a heavy resistance. The voltage of each cell should not fall below 1.6 Volts while the reading is being taken (10—15 seconds). Otherwise the cell is discharged or defective. The normal voltage is 2 Volts.

The battery poles should be cleaned with a clean cloth, or in the event of heavy corrosion, with a stiff brush. The battery poles and cable terminals should be coated with grease. Make sure that the battery is correctly grounded.

The state of charge of the battery can be checked with a hydrometer. The specific gravity of the acid will increase with the charging of the battery. The gravity can be read from a scale.

Battery fully charged	1.285 = 32° Bé
Battery semi-charged	1.230 = 27° Bé
Battery discharged	1.142 = 18° Bé

When laying your vehicle up for a prolonged period, it is advisable to take the battery to a workshop for storage. A battery which is not in constant use will discharge itself in time and this can result in permanent damage to the plates if the battery is not checked about every

48 4 weeks and charged as necessary.

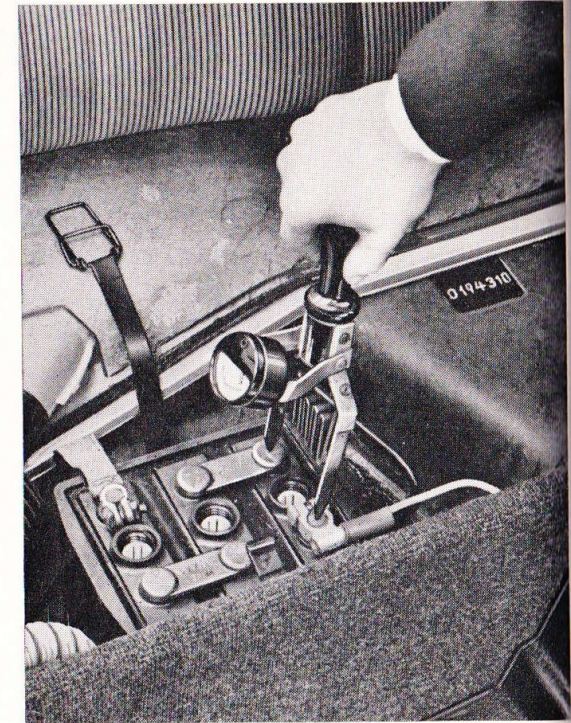

## Aiming the Headlights

If a headlight aiming device is not available, proceed as follows:

Position the vehicle on level ground 5 m (16 ft. 5 in.) in front of a dark wall which will serve as a screen. The tire pressures must be correct. The rear seat of the Sedan and the driver's seat of the Variant must be loaded with one person or a weight of 70 kg (154 lbs.).

Draw two crosses on the wall as shown in the sketch. The longitudinal center line of the vehicle must be lined exactly between the two crosses on the screen.

Aim the headlights individually by turning the two slotted screws in the head lamp rim with the beams dimmed. Cover up the second headlight.

The headlights are correctly aimed when the light-dark border line is horizontal on the adjusting line to the left of the cross and the angle on light-dark border line is exactly on the center of the cross.

a - 1,260 mm (49.6")

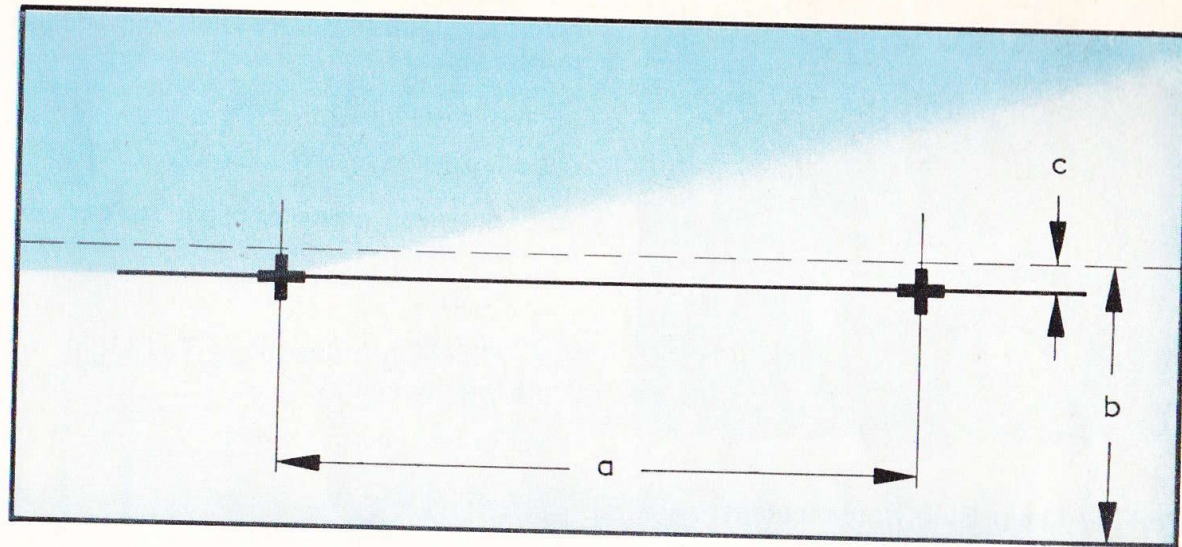

b - the height of the headlight center from the floor

c - Sedan 50 mm (2")

Variant 375 kg (827 lbs.) 150 mm (6")

Variant 460 kg (1,014 lbs.) 100 mm (4")

at a distance of 5 m (16 ft. 5 in.) from the screen

A - Horizontal Adjustment

B - Vertical Adjustment

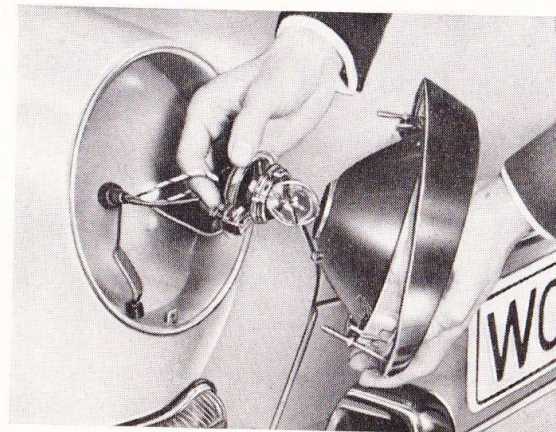

## Headlight Bulb Replacement

Loosen the Phillips screw at the bottom of the headlight rim and take out the lens and reflector unit.

Turn the cap to the left and take the holder out of the reflector.

Pull the connector off the bulb base and replace the bulb.

Never touch the bulb with the bare hand, but only with a clean cloth or a paper serviette etc. The lug in the lamp holder must engage in the notch provided in the reflector.

Insert the cap so that the contact strip is located on the base of the parking light bulb.

Check headlight adjustment.

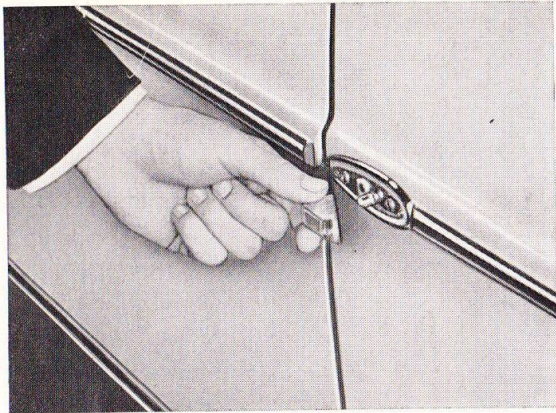

### Parking Lamp Bulb Replacement

Remove Phillips screw.

Remove housing with lens and replace bulb.

When installing, engage the housing with lens in the rear of the lamp base.

### Front Flashing Indicator Bulb Replacement

Remove two Phillips screws.

Remove lens and replace the bulb.

When installing make sure that the seal is correctly seated.

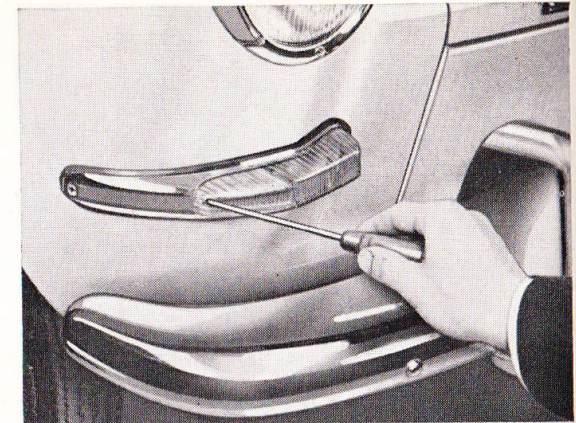

### Stop/Flashing Indicator or Tail Light Bulb Replacement

Remove two Phillips screws.

Take off lens.

Replace bulb.

Position of bulbs:

Upper — Flashing indicator bulb

Center — Tail light bulb

Lower — Stop light bulb

When installing the lens, make sure that the seal is correctly seated. Do not overtighten the screws.

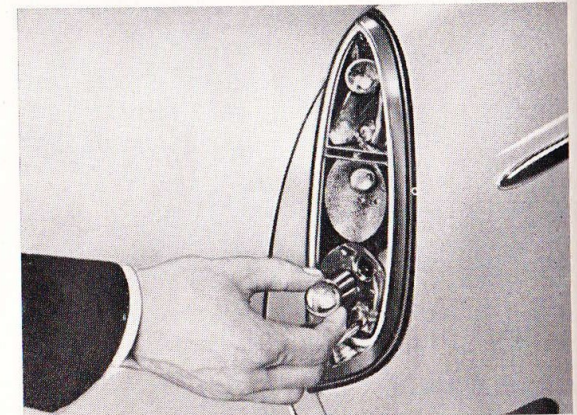

### Licence Plate Light Bulb Replacement

Open rear luggage compartment lid.

Remove both Phillips screws and take off lens with bulb holder.

Pull off bulb holder from lens.

Replace bulb.

When installing make sure that the cable grommet is correctly seated.

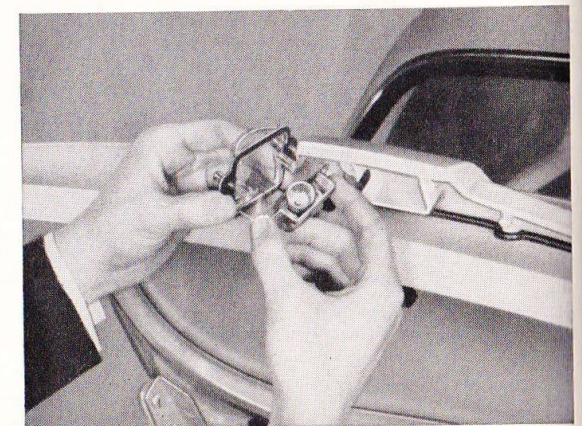

## Replacing Fuses

The fuse box is located to the left under the instrument panel. When a fuse has blown, it is not sufficient merely to replace it by a new one. Inspect the electrical system for evidence of short circuits or other faults.

Under no circumstances use fuses which have been patched with tin foil or wire as they would be liable to cause severe damage elsewhere in the electrical system. We suggest that you always carry a few fuses, i. e. 16 Amp. fuses for the wiper motor and 8 Amp. fuses for all the other electrical fittings.

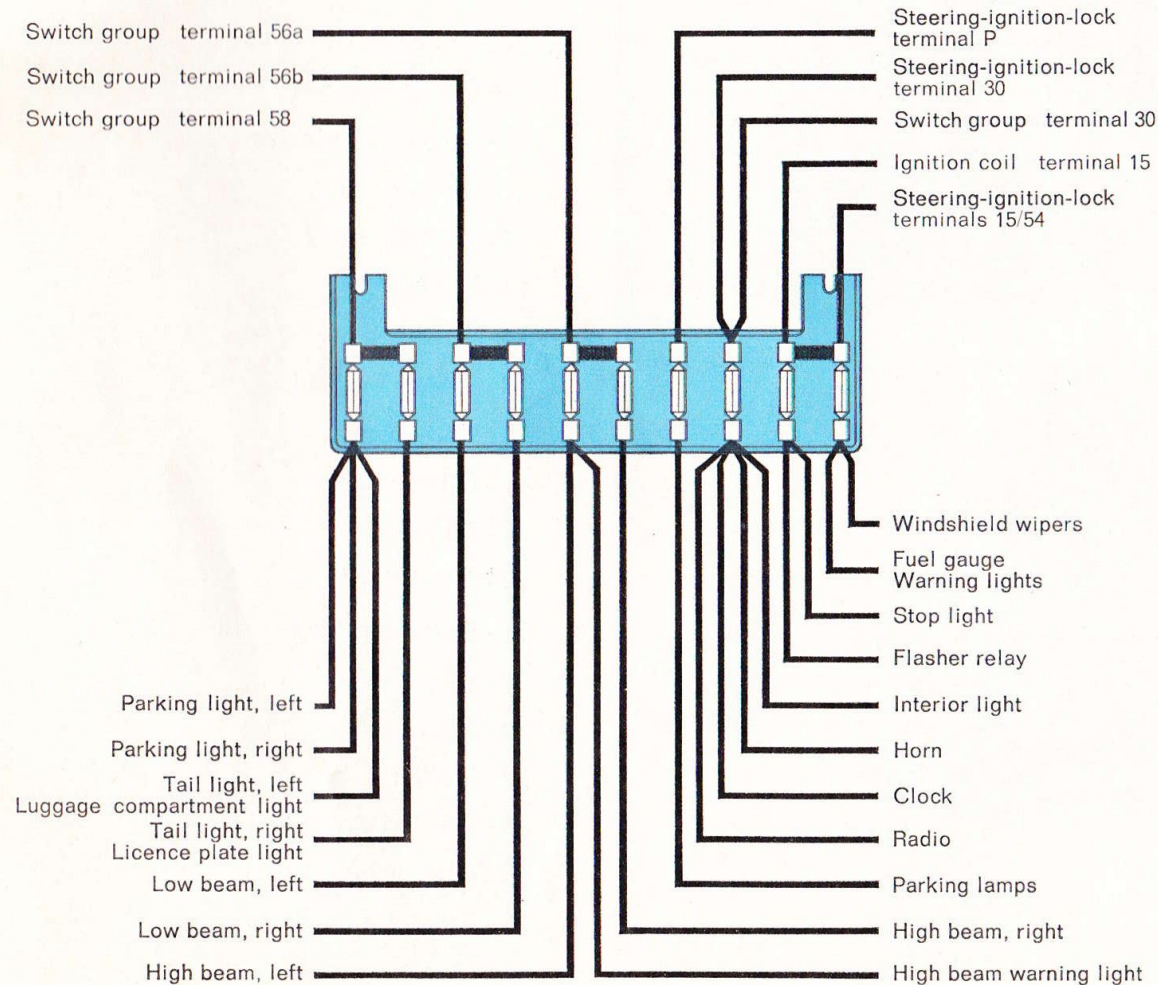
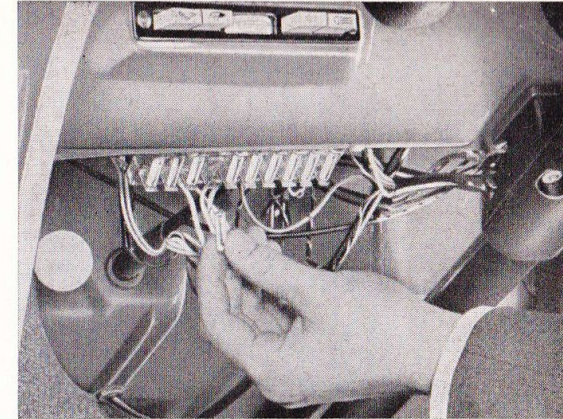

## Adjusting Doors

There should be no noticeable play between the lock and the striker plate. It must be possible to open the doors easily without any signs of their jamming. To adjust the door, loosen the three striker plate screws at the lock pillar and move the striker plate. Adjust the striker plate so that door and pillars are a flush fit. The striker plate is correctly adjusted if the housing on the door has the same clearance at top and bottom when sliding into the striker plate.

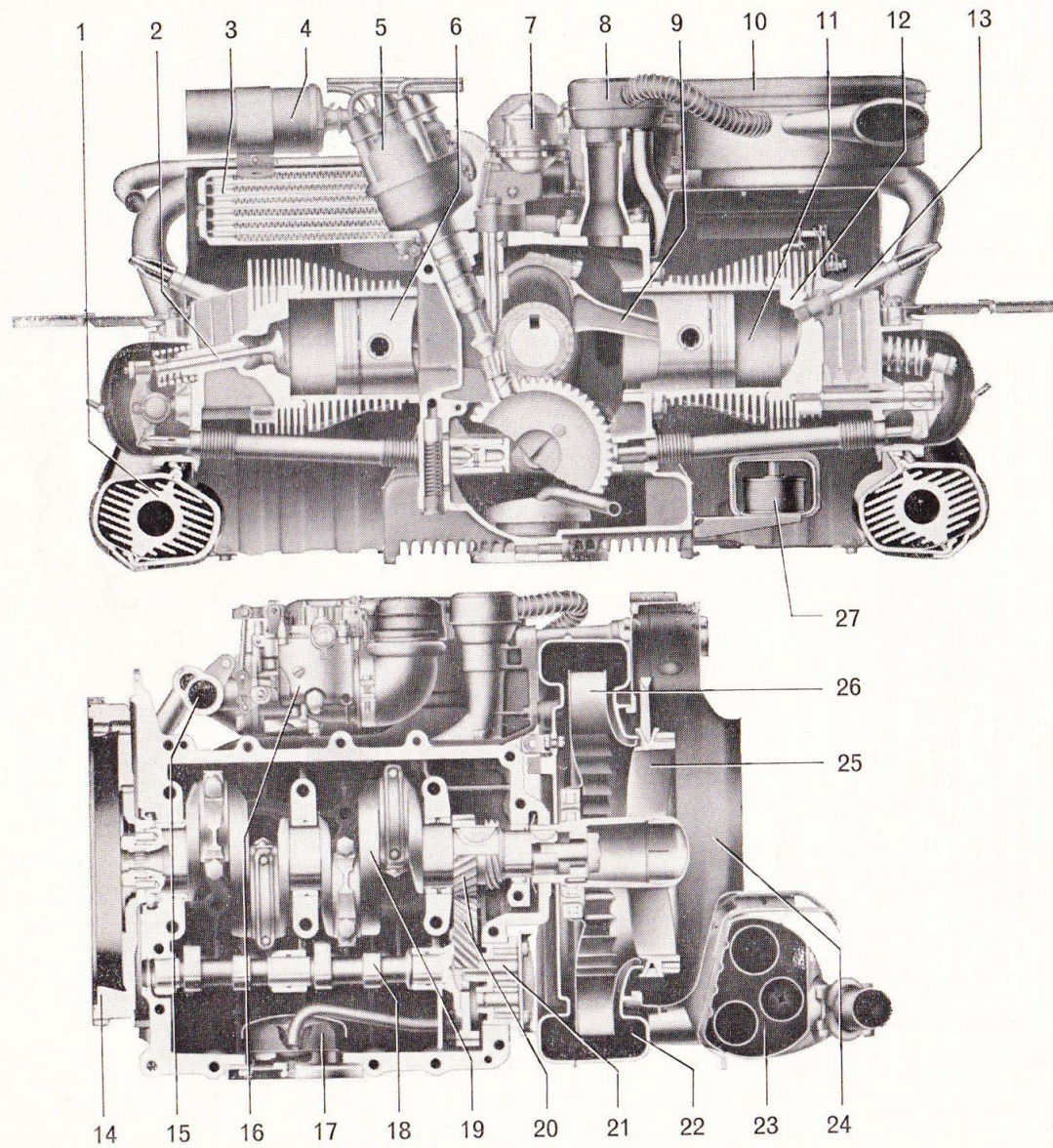

- 1 - Heat exchanger
- 2 - Valve
- 3 - Oil cooler
- 4 - Ignition coil
- 5 - Ignition distributor
- 6 - Piston
- 7 - Fuel pump
- 8 - Crankcase breather
- 9 - Connecting rod
- 10 - Oil bath air cleaner
- 11 - Cylinder
- 12 - Cylinder head
- 13 - Spark plug
- 14 - Flywheel
- 15 - Intake manifold
- 16 - Carburetor
- 17 - Oil strainer
- 18 - Camshaft
- 19 - Crankshaft
- 20 - Camshaft drive gears
- 21 - Oil pump
- 22 - Fan housing
- 23 - Muffler
- 24 - Cooling air intake housing
- 25 - Crankshaft pulley
- 26 - Fan
- 27 - Thermostat

## General Description

### Engine

The engine, located in the rear of the car, is attached by four bolts to the recessed flange of the rubber mounted transmission case. The crankcase is made of a light alloy. Two pairs of cylinders are horizontally opposed. Each pair has a common cylinder head made of light alloy. The overhead valves are located in the cylinder heads and are operated by the camshaft via cam followers, push rods and rocker arms. The short crankshaft rests in four bearings and is induction hardened at its bearing surfaces. The camshaft is driven from it by means of helical gears. The connecting rods are provided with lead-bronze-bearings. The pistons are of light alloy with steel inserts.

A side-draft carburetor with automatic choke and accelerator pump supplies the fuel-air mixture to the cylinders.

The oil pump of the pressure lubrication system is driven by the camshaft. The oil is drawn from the crankcase via a strainer and forced via an oil cooler to the lubrication points. When the oil is thick, an oil pressure relief valve enables the oil to flow direct to the lubrication points by by-passing the oil cooler.

The engine is cooled by a fan mounted on the crankshaft. The fan sucks in air through an opening in the cooling air intake housing and forces it through the fins of the cylinders. The flow of cooling air is regulated by a thermostat and this ensures a constant operating temperature.

The engine is equipped with battery ignition. The spark advance is controlled automatically by a vacuum mechanism. The generator is driven by a V belt. The generator pulley can be adjusted to alter the V belt tension.

### Chassis

The frame with its central tunnel is of pressed steel. It is forked at the front and supports the rubber mounted front axle. The engine-transmission unit is rubber mounted at three locations in a special sub-frame. The sub-frame with the engine and transmission unit is also rubber mounted at five locations to frame and body. A further rubber mounting supports the engine at the rear on the body. The following parts pass through the center of the frame:

Gear shift rod, fuel line, the warm air tube for the center defroster vent and, in conduits, the cables for hand brake, clutch, accelerator pedal and fresh air heating.

The front axle beam is of pressed steel and is provided with bearing tubes for the four torsion arms. The front wheels are individually suspended by two adjustable crossed torsion bars in the lower axle tube. A torsion bar extending between the two upper torsion arms serves as a stabilizer.

The roller type steering gear acts on the front wheels via divided tie rods. A steering damper ensures steering steadiness.

The rear axle is of the swinging half axle design. The rear wheels are independently sprung and have adjustable torsion bars. The Variant — 460 kg (1,014 lbs.) — is provided with an additional torsion bar which is positioned diagonally above the rear axle.

Double-acting hydraulic shock absorbers in front and rear prevent excessive rebound.

### **Transmission and Rear Axle**

Power from the engine is transmitted to the gears via a dry single-plate clutch. The transmission case houses the transmission with four forward speeds, one reverse, and the differential.

All the forward gears are synchronized. The gears are helically cut to provide silent operation.

The drive pinion and the ring gear are cut spirally. The two swinging rear axle shafts are pivoted in the differential.

### **Brakes**

The hydraulic foot brake on the front wheels is provided with two brake cylinders per wheel and at the rear with one brake cylinder per wheel. The hand brake operates on the rear wheels via cables.

### **Body**

The two-door body is made of pressed steel and electrically welded. It is bolted to the frame. Both window doors can be lowered. Hinged quarter windows and vent wings in the doors ensure draft-free ventilation. Both front seats can easily be adjusted while driving. The luggage compartments under the front and rear hoods are secured against theft when the car is locked. Both these locks are operated by cables. The fuel tank and spare wheel are located in the front luggage compartment. The engine compartment is accessible through the rear luggage compartment.

The roof of the Variant is extended at its full height to the rear of the vehicle. The vehicle has two fixed and two hinged quarter windows. The load compartment is accessible through the rear door which is held open by torsion bars. By tipping the rear seat forward the load surface can be increased by more than half its size.

### **Heating System**

The fresh air drawn in by the fan is heated in heat exchangers. It is emitted through three defroster vents on the windshield and two controllable outlets each in front and rear foot wells. The heating is regulated by two levers situated beside the driver's seat on the frame tunnel.

### **Ventilation**

The air for the ventilation is drawn in through two openings in front of the windshield. Depending on the position of the three regulating levers on the instrument panel, the fresh air enters either through vents on the windshield or through outlets above foot level.

- 1 - Transmission shift lever
- 2 - Bonded rubber mounting
- 3 - Gearshift housing
- 4 - 4th gear train
- 5 - Gear carrier
- 6 - Oil drain plugs
- 7 - 3rd gear train
- 8 - 2nd gear train
- 9 - Main drive shaft, front
- 10 - 1st gear train
- 11 - Drive pinion
- 12 - Reverse gear
- 13 - Differential pinion
- 14 - Differential side gear
- 15 - Clutch release bearing
- 16 - Clutch operating shaft
- 17 - Main drive shaft, rear
- 18 - Reverse sliding gear
- 19 - Reverse shaft
- 20 - Oil filler plug
- 21 - Reverse drive gear
- 22 - Ring gear
- 23 - Fulcrum plates
- 24 - Rear axle shaft
- 25 - Differential housing

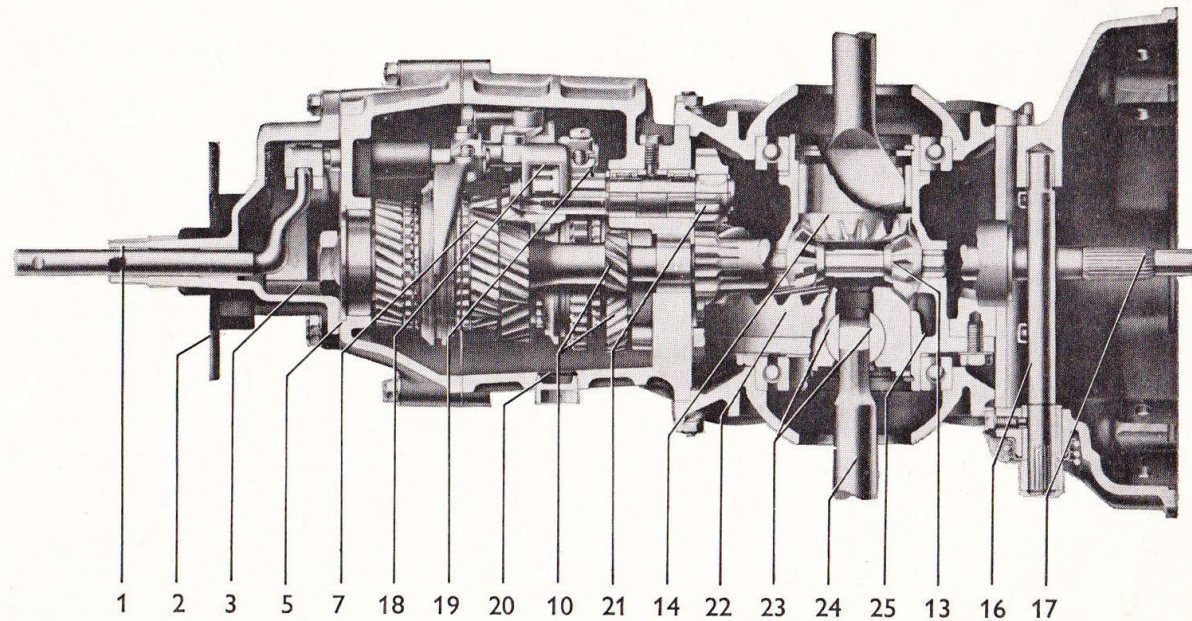
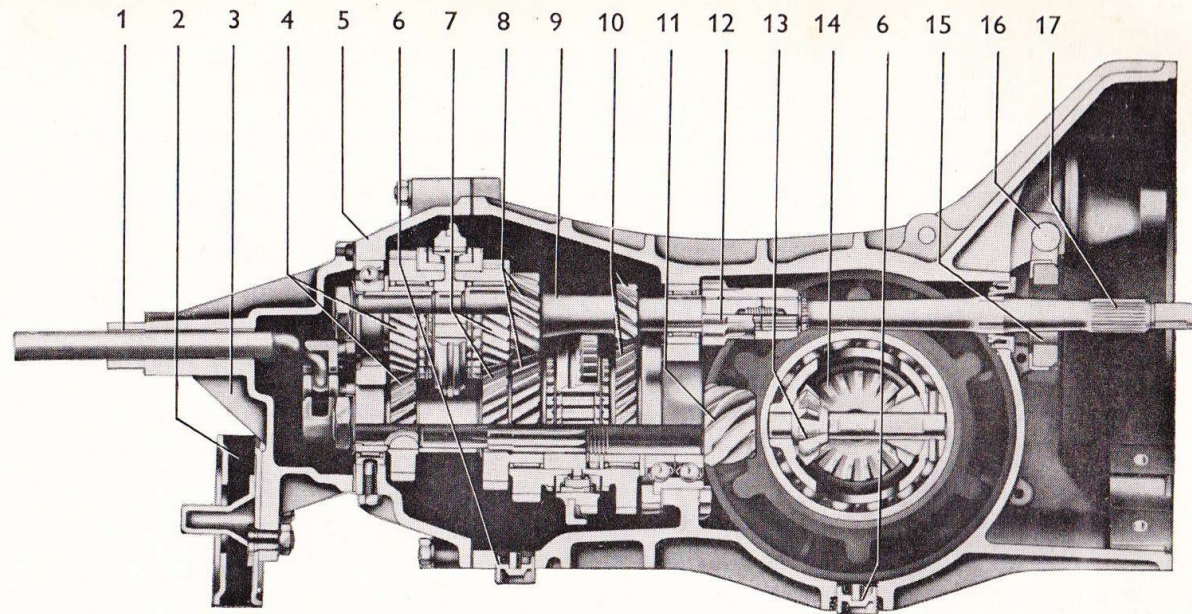



## Technical Data

### Engine

Design . . . . .	4 cylinder, 4 stroke in rear of car
Arrangement of cylinders . . . . .	Two pairs, horizontally opposed (flat four)
Bore . . . . .	83 mm (3.27")
Stroke . . . . .	69 mm (2.72")
Capacity . . . . .	1493 c. c. (91.09 cu. ins.)
Compression ratio . . . . .	7.8 : 1
Valves . . . . .	Overhead
Valve clearance with engine cold . . . . .	Intake 0.30 mm (.012") Exhaust 0.30 mm (.012")
Maximum output (SAE) . . . . .	54 bhp. at 4200 rpm.
Lubrication . . . . .	Force feed by gear pump. Oil cooler
Oil capacity . . . . .	2.5 liters (5.3 U.S. pints; 4.4 Imp. pints)
Fuel delivery . . . . .	Mechanical fuel pump
Carburetor . . . . .	Side draft Solex 32 PHN
Cooling . . . . .	Air cooling by fan mounted on crankshaft, controlled automatically by thermostat
Battery . . . . .	6 Volt, 77 Amp.
Starting motor . . . . .	6 Volt, 0.6 bhp.
Generator . . . . .	6 Volt, 200 Watt at 2600 rpm. with regulator
Ignition distributor . . . . .	Vacuum spark advance
Firing order . . . . .	1 — 4 — 3 — 2
Initial spark advance . . . . .	10° before TDC
Breaker point gap . . . . .	0.4 mm (.016")
Spark plugs . . . . .	14 mm thread Bosch W 175 T 1 Beru 175/14

Champion L 85  
or plugs with similar values from  
other manufacturers

Spark plug gap . . . . . 0.7 mm (.028")

### Clutch

Design . . . . . Single plate, dry  
Pedal free-play . . . . . 10 — 20 mm (.4" — .8")

### Transmission

4 forward speeds, 1 reverse  
All forward gears synchronized and silent.  
Gear ratios . . . . . First 3.80 : 1 Third 1.32 : 1  
Second 2.06 : 1 Fourth 0.89 : 1  
Reverse 3.88 : 1

### Rear Axle

Power is transmitted through spiral drive pinion and ring gear, via two swinging half shafts to the rear wheels.  
Ratio . . . . . 4.125 : 1  
Oil capacity of transmission . . . . . 3.0 liters (6.3 U.S. pints; 5.3 Imp. pints)

### Chassis

Front suspension . . . . . 2 torsion bars, stabilizer  
Rear suspension . . . . . 2 torsion bars  
Variant — 460 kg (1014 lbs.) — additional torsion bar  
Shock absorbers . . . . . Double-acting telescopic shock absorbers at front and rear  
Steering . . . . . Roller type with divided tie rod, hydraulic steering damper  
Turning circle . . . . . Approximately 11.1 m (36.5 ft.)  
Wheels . . . . . Disc wheels with drop center rims  
4½ J × 15  
Tires Sedan and Variant  
375 kg (827 lbs.) . . . . . 6.00 — 15 L, tubeless  
Variant 460 kg (1014 lbs.) 6.00 — 15 L 6 PR, tubeless

**Inflation pressure**

**Sedan:**

- 1 to 2 occupants ..... Front 1.1 kg/cm<sup>2</sup> (16 psi.)  
Rear 1.7 kg/cm<sup>2</sup> (24 psi.)
- 3 to 5 occupants ..... Front 1.2 kg/cm<sup>2</sup> (17 psi.)  
Rear 1.7 kg/cm<sup>2</sup> (24 psi.)

**Variant — 375 kg (827 lbs.)**

- with half payload ..... Front 1.2 kg/cm<sup>2</sup> (17 psi.)  
Rear 1.7 kg/cm<sup>2</sup> (24 psi.)
- with full payload ..... Front 1.2 kg/cm<sup>2</sup> (17 psi.)  
Rear 2.5 kg/cm<sup>2</sup> (36 psi.)

**Variant — 460 kg (1014 lbs.)**

- with half payload ..... Front 1.2 kg/cm<sup>2</sup> (17 psi.)  
Rear 1.7 kg/cm<sup>2</sup> (24 psi.)
- with full payload ..... Front 1.2 kg/cm<sup>2</sup> (17 psi.)  
Rear 2.7 kg/cm<sup>2</sup> (38 psi.)

- Wheelbase ..... 2400 mm (94.5")
- Track ..... Front 1310 mm (51.6")  
Rear 1346 mm (53.0")
- Toe-in (unladen) ..... 4 to 6 mm (0.16"—0.24")
- Camber (unladen) ..... 1° 20' ± 10'
- Foot brake ..... Hydraulic, acting on all wheels
- Hand brake ..... Mechanical, acting on rear wheels

**Dimensions and Weights**

	Sedan	Variant 375 kg	Variant 460 kg
Length .....	4225 mm (166.3")	4225 mm (166.3")	4225 mm (166.3")
Width .....	1605 mm (63.2")	1605 mm (63.2")	1605 mm (63.2")
Height .....	1475 mm (58.1")	1465 mm (57.7")	1465 mm (57.7")
Ground clearance .....	149 mm (5.9")	144 mm (5.8")	144 mm (5.8")
Unladen weight (kerb weight) .....	880 kg (1940 lbs.)*	985 kg (2171 lbs.)**	995 kg (2193 lbs.)**
Max. load .....	400 kg (881 lbs.)	375 kg (827 lbs.)	460 kg (1014 lbs.)
Max. total weight .....	1280 kg (2821 lbs.)	1360 kg (2998 lbs.)	1455 kg (3206 lbs.)

	Sedan	Variant 375 kg	Variant 460 kg
Max. load on front axle .....	550 kg (1212 lbs.)	550 kg (1212 lbs.)	550 kg (1212 lbs.)
Max. load on rear axle .....	750 kg (1653 lbs.)	920 kg (2028 lbs.)	975 kg (2149 lbs.)

\* without driver    \*\* including driver

**Fuel**

Fuel consumption according to DIN 70 030 is approximately 8.4 liters per 100 km i.e. 28 mpg. U.S., 34 mpg. Imp. (Measured consumption plus 10% with half load and at a steady ¾ of top speed 94 kph./58 mph.).

- Oil consumption ..... 0.5 — 1.0 liters per 1000 km  
1.7 — 3.4 U.S. pints per 1000 miles  
1.4 — 2.8 Imp. pints per 1000 miles

**Refill Requirements**

- Fuel tank ..... 40 liters (10.6 U.S. galls.; 8.8 Imp. galls.)
- Engine ..... 2.5 liters of engine oil (5.3 U.S. pints; 4.4 Imp. pints)
- Rear axle and transmission .. 2.5 liters of hypoid oil (5.3 U.S. pints; 4.4 Imp. pints)
- Steering ..... 0.16 liters of hypoid oil (0.34 U.S. pint; 0.28 Imp. pint)
- Brakes ..... 0.25 liters of brake fluid (0.53 U.S. pint; 0.44 Imp. pint)
- Oil bath, air cleaner ..... Approx. 0.25 liters engine oil (0.53 U.S. pint; 0.44 Imp. pint)

Container for windshield washer ..... Approximately 2 liters of water (2 quarts) Air pressure: 2.5 kg/cm<sup>2</sup> (36 psi.)

**Performance**

Maximum and cruising speed 125 kph. (78 mph.)

Climbing ability ...	Sedan*	Variant 375 kg**	Variant 460 kg**
First gear	45.5 %	40.0 %	38.0 %
Second gear	23.5 %	20.0 %	19.0 %
Third gear	14.0 %	12.0 %	11.5 %
Fourth gear	7.5 %	6.5 %	6.0 %

\* with 2 persons  
\*\* half payload

### Bulb Chart

V = Volt, W = Watt

Bulb for	Description according to German Standard DIN 72 601	Part Number	Bulb for	Description according to German Standard DIN 72 601	Part Number
Headlights . . . . .	A 6 V 45/40 W	N 17 705 1	Tail lights . . . . .	G 6 V 5 W	N 17 718 1
Parking lights and parking lamps . . . . .	HL 6 V 4 W	N 17 717 1	Licence plate light . . . . .	G 6 V 10 W	N 17 719 1
Flashing indicator front and rear, stop light . . . . .	R 6 V 18 W	N 17 731 1	Speedometer, clock, fuel gauge, warning lights . . . . .	J 6 V 1.2 W	N 17 722 1
			Interior and luggage compartment lights . . . . .	K 6 V 10 W	N 17 723 1



### Tools and Accessories

- 1 Tool roll
- 1 Wheel cap removal tool
- 1 Combination pliers
- 1 Screwdriver with double-ended blade for Phillips and slotted screws
- 1 Open end wrench 10 × 13 mm
- 1 Spare wheel, complete
- 1 Jack
- 1 Open end wrench 27 mm (in conjunction with the socket for removing the spark plugs)
- 1 Wrench for spark plugs and wheel mounting bolts
- 1 Socket 14 mm
- 1 Operating bar for sockets and jack

# Maintenance Chart

500 km 300 miles	5,000 km 3,000 miles	Operation	Every
		Check for tightness: Nuts and bolts on chassis, body, engine, rear axle, front axle and steering	
		Check engine and rear axle for leaks	
		Check tire pressures and wheel mounting bolts for tightness	
		Check front wheel bearing play	
		Check V-belt	<b>5,000 km 3,000 miles</b>
		Check air cleaner, clean lower part if necessary	
		Clean fuel pump filter	
		Check breaker points, lubricate distributor, check contact breaker gap and timing	
		Check valve clearance	
		Check spark plugs and compression	
		Check exhaust system for damage. Check rubber valve for crankcase ventilation and preheater pipe valve	

500 km 300 miles	5,000 km 3,000 miles	Operation	Every
		Check water drain flaps and cooling air bellows	<b>5,000 km 3,000 miles</b>
		Check clutch pedal free-play	
		Check dust seals of ball joints and tie rod ends, security of tie rods and steering damper	
		Check axial play of upper torsion arms, camber and toe-in of front wheels	
		Check steering gear adjustment	
		Check tires for wear and damage, check tire pressures	
		Check brake system for damage and leaks. Check brake fluid level and hand and foot brake adjustment	
		Check thickness of brake linings	
		Check battery, check electrical system and headlight adjustment	
		Road test: Check foot and hand brake operation. Check heating, idling adjustment and ventilation	
		Clean, grease and adjust front wheel bearings	<b>50,000 km 30,000 miles</b>

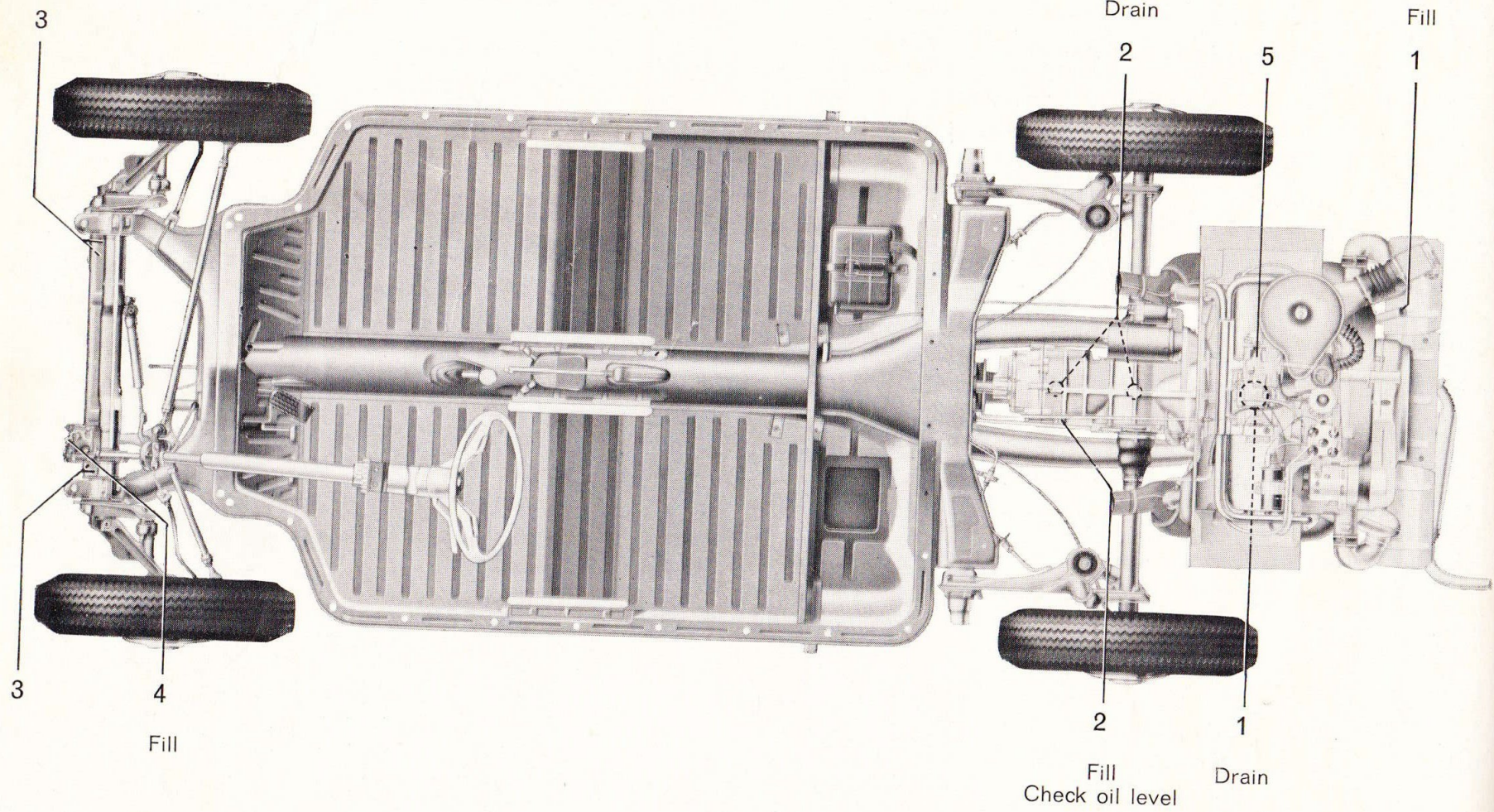

# Lubrication Chart

500 km 300 miles	2,500 km 1,500 miles	5,000 km 3,000 miles	No.	Lubrication Points	Every
			1	Engine: Change oil, clean oil strainer	<b>5,000 km 3,000 miles</b>
			2	Transmission: Check oil level	
			3	Front axle: Lubricate	
			4	Steering gear: Check oil level	
				Lubricate door and hood locks, door hinges	
			5	Lubricate carburetor linkage	<b>50,000 km 30,000 miles</b>
			2	Transmission: Change oil, clean magnetic oil drain plugs	

# Lubricants

Lubricant	Lubrication Points	Temperature		Viscosity Grade
		°C	°F	
Engine oil (Branded HD oil for spark- ignition engines)	Engine Carburetor linkage Oil bath air cleaner Door hinges Felt ring in contact breaker base plate	above	0 32	SAE 30
		below	0 32	SAE 10 W
		below	-25 -13	SAE 5 W
Hypoid oil	Transmission	SAE 90 all the year*		
	Steering gear	SAE 90 all the year		
Universal grease	Door and hood locks	cold-resistant water-repellent high pressure grease		
Lithium grease	Front axle Front wheel bearings breaker arm fiber block in distributor	Multi-purpose grease		

\* SAE 80 all the year in countries with arctic climates

# Index

Accelerator pedal .....	5		
— accelerating .....	18		
Accessories .....	61		
Air cleaner — cleaning .....	37		
Ash tray .....	11		
Battery — maintenance .....	48		
— care in winter .....	25		
Body — airing .....	30		
— description .....	54		
Brakes — adjusting .....	46/47		
— application .....	23		
— bleeding .....	47		
— care in winter .....	25		
— checking .....	17/46		
— description .....	54		
Brake pedal .....	5		
Breaking-in (running-in) .....	20		
Bulb chart .....	56		
Carburetor adjusting .....	43		
— type .....	56		
Camber .....	57		
— setting .....	45		
Care of the car .....	28		
Chassis — description .....	53		
— lubrication .....	34		
Chassis number .....	4		
Chromium-plated parts — care .....	30		
62 Climbing ability .....	57		
		Clock .....	11
		Clutch — design .....	56
		— pedal .....	5
		— pedal free-play .....	44/56
		Cold weather hints .....	24
		Compression .....	41
		— ratio of engine .....	56
		Contact breaker points — setting .....	39
		— cleaning ...	38
		Controls and instruments .....	5
		Cooling of engine .....	56
		Description — general .....	53
		Dimensions — overall .....	57
		Dimming — headlights .....	8
		Dipstick .....	17
		Doors .....	6
		— care of weather strips .....	30
		— adjusting .....	51
		— inside handle .....	6
		— lubrication points .....	35
		— locks frozen .....	25
		Driving down-hill .....	23
		Economy .....	22
		Engine — compartment .....	13
		— description .....	53
		— design .....	56
		— lubrication (oil change) .....	56
		— number .....	4
		— oil change in winter .....	25
		— oil change and refill requirements .....	31
		— oil strainer .....	31
		— speed .....	57
		— sectional view .....	52
		— technical data .....	56
		— type of oil .....	32
		Firing order .....	56
		Flashing indicator bulb — replacement ..	50
		Flashing indicator switch .....	9
		Foot brake — adjusting .....	46
		— bleeding .....	47
		— description .....	54
		Fresh air ventilation — operation .....	10
		— description .....	54
		Front axle — description .....	53
		— lubrication .....	34
		— technical data .....	56/57
		Front seats — adjustment .....	7
		Front wheel bearings — adjusting .....	44
		— lubrication ...	35
		Fuel consumption .....	57
		Fuel delivery .....	56
		Fuel filter-cleaning .....	38
		Fuel tank — capacity .....	15/57
		— reserve .....	16
		Fuse box .....	51
		Fuses — replacing .....	51
		Gear lever .....	5
		Gear shifting .....	20
		— on gradients .....	21
		Generator .....	56
		Ground clearance .....	57
		Hand brake — adjusting .....	47
		— description .....	54
		Headlights .....	8
		— aiming .....	49
		— changing bulb .....	50
		— flasher .....	9
		Heating — description .....	54
		— operation .....	24
		Horn lever .....	5

Identification plate .....	4
Idling — checking and adjusting .....	43
Ignition — setting .....	38
— distributor .....	56
— firing order .....	56
— lubrication of distributor .....	39
Instrument light .....	9
Interior light .....	9
Jack — application .....	26/27
Keys .....	6
Leatherette — care of .....	30
License plate light — replacing bulb ...	50
Lighting .....	9
Loading surface — Station Car .....	15
Load compartment light .....	15
Lubricants .....	59
Lubricant — additives .....	34
Lubrication service .....	31
Lubrication chart .....	59
Luggage compartments .....	12
Maintenance service .....	36
Maintenance chart .....	60
Maximum output .....	56
Maximum speed .....	57
Oil consumption .....	57
Oil level — engine .....	16
— dipstick .....	17
— specifications .....	32
— steering gear .....	34
— transmission .....	33
Operating instructions .....	6
Paintwork — preservation .....	28
— polishing .....	29
Parking your car .....	23
Parking lamps .....	9
— bulb replacement .....	50

Parking lights .....	8
Practical driving .....	20
Ratios — rear axle .....	56
— transmission .....	56
Rear axle — description .....	54
— technical data .....	56
— transmission of power .....	56
Rear door — Station Car .....	14
Rear view mirror .....	7
Reverse gear .....	21
Safety belts .....	13
Seat adjustment .....	7
Shifting gears .....	20
Shock absorbers — design .....	56
Snow chains .....	25
Spare wheel .....	26
Spark plugs — checking and cleaning .	41
— gap .....	25/41
— removal .....	41
Speedometer .....	5
Speed ranges .....	20
Spots — removal .....	30
Starting the engine .....	18
Starting motor .....	56
Station Car .....	14
Steering ignition lock .....	18
Steering — adjusting .....	45
— type .....	56
— lubrication .....	34
Stop light — bulb replacement .....	50
— checking .....	17
Sun vizors .....	7
Suspension — front .....	56
— rear .....	56
Tail light — replacing bulb .....	50
Technical data .....	56

Tires — inflation pressure .....	17/57
— maintenance .....	26
— M + S tires .....	25
— size .....	56
— wear .....	26
Toe-in .....	57
— adjusting .....	45
Tools and accessories .....	61
Torsion arms — checking play .....	45
Track (tread) .....	57
Transmission — description .....	54/56
— oil change .....	
and capacity .....	33/34
— sectional view .....	55
— oil change in winter ...	25
Turning circle .....	56
Type of fuel .....	16
Upholstery — care of cloth .....	30
Valves — adjusting .....	42
— arrangement .....	56
— clearance .....	42/56
V-belt — checking and adjusting .....	36
Vent wing .....	5
Warning lights .....	19
Washing your car .....	28
Weights .....	57
Wheel base .....	57
Wheels — balancing .....	26
— changing .....	26
— rim size .....	56
Windows — cleaning .....	30
Window regulator handle .....	5
Window weather strips — care .....	30
Windshield wiper switch .....	8
Windshield washer .....	8



$$\begin{array}{r} 128 \\ 2 \\ \hline 944 \end{array}$$

$$\begin{array}{r} 9272 \\ 2 \\ \hline 18544 \end{array}$$
  
 221011

$$\begin{array}{r} 22 \\ 2413142 \\ \hline 48919 \end{array}$$

$$\begin{array}{r} 61792 \\ 26217 \\ \hline 12014 \end{array}$$
  
 221011

11

© 1963 Volkswagenwerk Aktiengesellschaft  
 All rights reserved. May not be reproduced  
 or translated in whole or in part without the  
 written consent of Volkswagenwerk AG.  
 Specifications subject to alteration without  
 notice.