

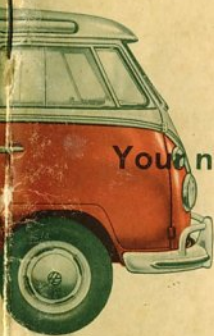

Your new Volkswagen Station Wagon

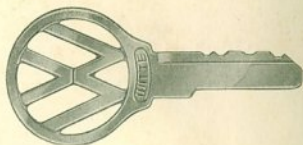



Keys	2
Getting acquainted	8
Driving	16
When it gets cold	24
Keeping it clean	26
Trouble shooting guide	30
Lubrication	40
Preventive Maintenance	52
How your Volkswagen works	72
Technical data	76
Index	78
Your VW inside out	80
Reference Data Record back cover	

Your key to get to know your new car

Welcome to the Volkswagen driving fraternity. For it is a fraternity, really. Just as the VW is a somewhat unique automotive concept, VW owners quickly pick up the reputation of being automotive aficionados. One of the virtues of the Volkswagen is that it brings back the pleasure of driving — instead of being driven in — a car. And you will enjoy your Volkswagen even more if you are completely familiar with its operation. Thus, the purpose of this book is to provide you with all the knowledge you will need to lead VW bull sessions or cope with most any situation you could encounter. We even explain, for instance, what to do if you are stuck in the snow, although we know that you probably never will be. Sometimes you may think we are being a little basic. However, if you've never driven a Volkswagen before you may be unfamiliar with the location of certain switches or knobs. And if you have a young driver in your family this manual will be an excellent addition to his driver training. Many pages are devoted to lubrication and routine preventive maintenance. Why? Under certain circumstances you could be called upon to service your Volkswagen yourself. However, we recommend that you let your Authorized VW Dealer take care of your vehicle. He has the equipment and factory-trained mechanics who do nothing but work on Volkswagens all day long. So they're pretty good at it. It will be valuable for you to read this owner's manual completely through to see what information it contains. You may learn a lot of new things which will help you get the most out of your Volkswagen. We wish you many miles of pleasant driving.

This key will open all the doors for you

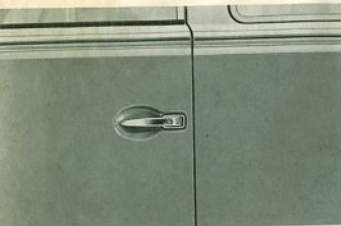

this one

the ignition key locks or unlocks the driver's door by turning clockwise or counterclockwise, respectively.



and these two

The side loading doors may be likewise locked from the outside or from the inside by turning the locking knob. To open these doors flush against the side of the vehicle all you have to do is to remove the retaining straps from the inside hook.



and this one

The rear flip-up door can be locked or opened only from the outside. When raised it will lock in one of two open positions automatically. To release it just raise the door slightly higher and remove the checkrod from the stop position.

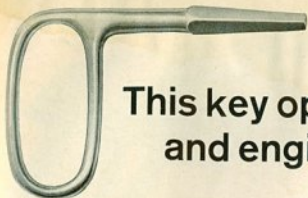

This key opens the gas tank and engine compartment

here's where you find it

The square key is located on the wall beside the steering column.



the gas tank

You can open the gas cap door with the square key.

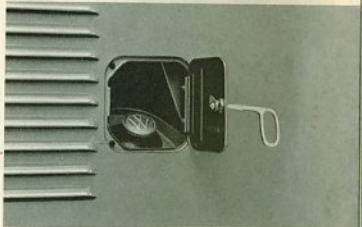

the engine compartment

The square key also opens the engine compartment lid. To close the lid push in against the end tab of the horizontal bar of the check mechanism.





Now take your key, open the door



or and step inside



Sit down and make yourself comfortable

The comfortable individual driver's seat adjusts separately to an infinite number of combinations. The seat slides back or forth into six different positions (4-inch

play) by turning the seat adjustment lever in the front of the seat upwards. The back rest can be adjusted forward by rotating the infinite adjustment knobs.

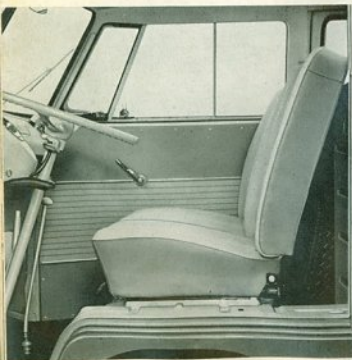

See to it that all your passengers are comfortable too

Reversing the middle seat. For long trips or for a car pool you can arrange the middle seat to face rearward, as in a club car. This is convenient for conversation or even a few rubbers of bridge. Follow the instructions below for unfastening the seat.

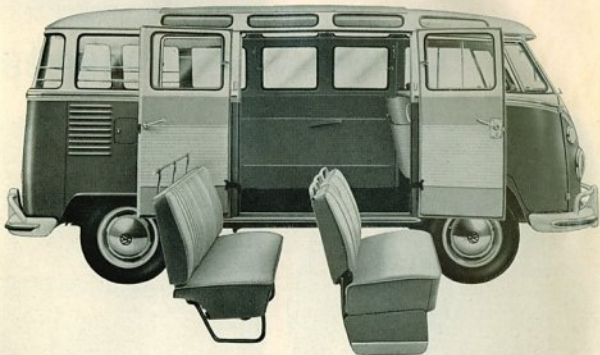

Want to carry a lot... Just take the seats out

Removing the rear seat. To remove the rear seat from the VW Station Wagon you will need the hexagonal wrench from your tool kit. Unfasten the hexagonal screws which hold the brackets from underneath and remove the seat.

Removing the middle seat. In the VW Station Wagon you can remove the middle seat to load cargo by unfastening the hexagonal screws securing it to the floor.

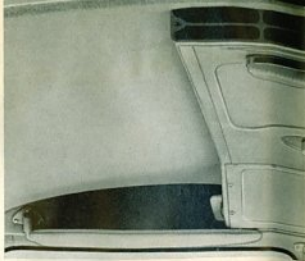

Look all around you and get

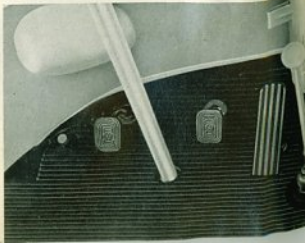
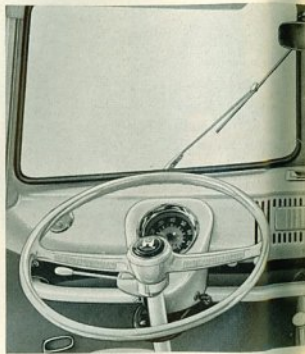
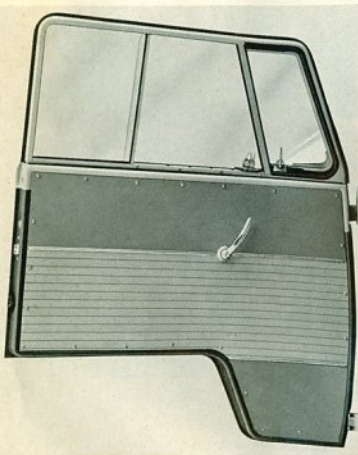

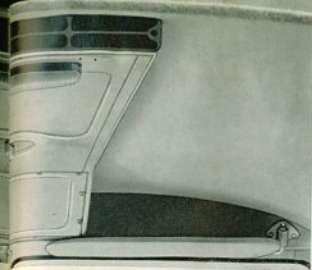

acquainted with everything

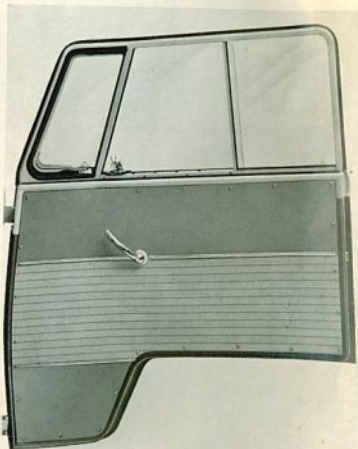
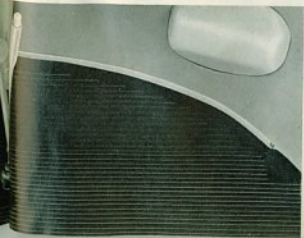

Plenty of fresh air in this car

You'll get lots of fresh air in this VW Station Wagon. There are 10 windows that can be opened and 15 more to let in sunshine. 25 in all. Plus a sunroof up top.



1. A sunroof you can open.
2. A ventilator that changes all the air once every minute.
3. A window that pivots.
4. A window that slides.
5. A door handle that opens and locks safely.

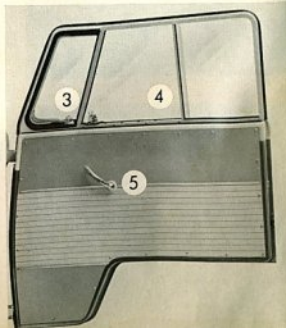
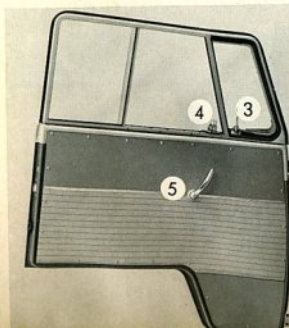

1.

To open the sunroof you turn the handle to the left, slide the sunroof as far open as you like, then lock it in place by turning the handle to the right.



2.

The lever to the left of the duct turns on to one of three positions: to turn it off, move the lever all the way to the rear. The handle in the center of the duct directs the air into the cab (by turning it counter-clockwise) or passenger compartment (by turning it clockwise).

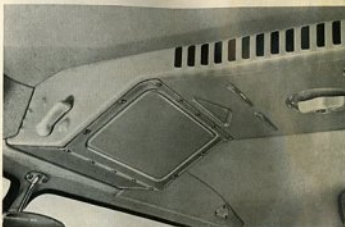

3/4.

The vent window directs air into the front seat area without any draft. You can if you want even more fresh air, slide the side windows to the rear after squeezing the release mechanism.

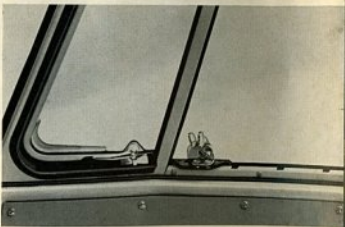

5.

To open the door, push downward on the door handle. To lock it safely, push upward.

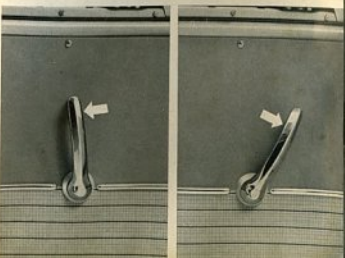

Look...
you can see all controls at a glance

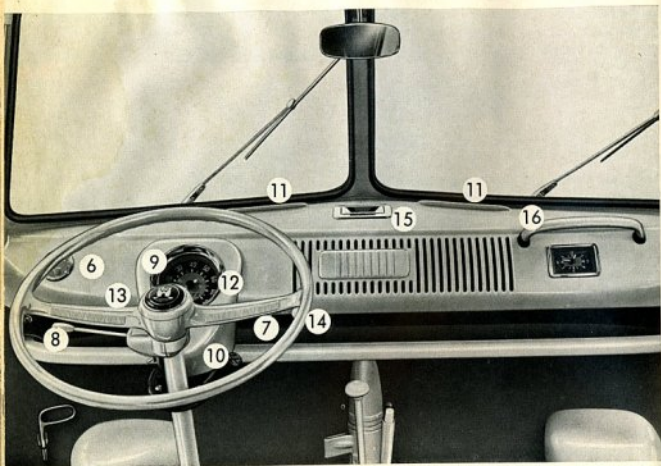

6. Gas gauge
7. Headlight switch
8. Turn indicator lever
9. Speedometer
10. Ignition switch
11. Defroster vents
12. Warning lights
13. Windshield wiper switch
14. Safety flasher switch
15. Ashtray
16. Passenger grab handle

9/12.

The central dial contains the speedometer, mileage indicator, warning lights, and turn indicator arrows.



6.

The gas gauge will tell you instantly how much gas you have in your tank. When the needle points to reserve (R) you have enough gas to go approximately 30 miles.

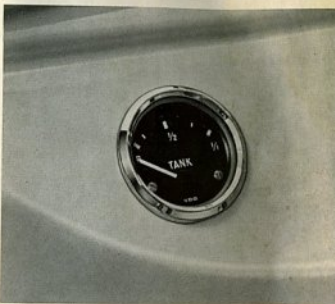

15.

The ashtray in the top of the dashboard can be removed for emptying by pushing it upward from under the dash panel. The ashtrays in the passenger compartment of the VW Station Wagons are pulled up for removal.



...and everything is easy to reach

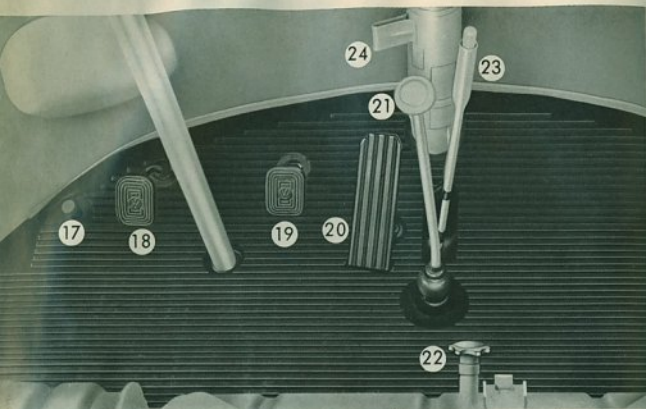

- 17. Headlight dimmer switch
- 18. Clutch pedal
- 19. Brake pedal
- 20. Accelerator pedal
- 21. Gear shift lever
- 22. Heater control knob
- 23. Hand brake
- 24. Heater vent control

22/24.

You can warm up the VW Station Wagon by turning the heater control knob counter clockwise — shut off the heater by turning the knob clockwise.

To achieve defrosting action, turn the heater vent control to close the heater outlets.

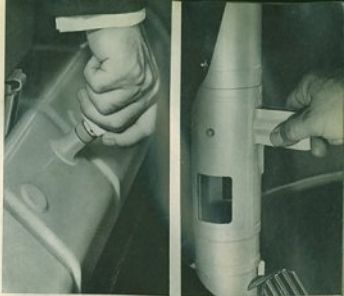

18/20/21.

The two pedals used in shifting gears, the clutch and the accelerator, are side by side, conveniently positioned to use.

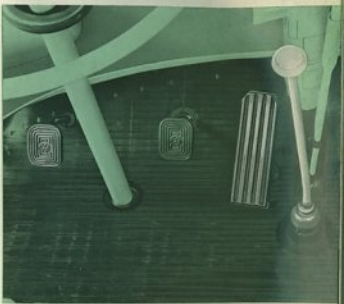

19/23.

The positive action hand brake can be used for parking or in an emergency situation.





Now take your key and

First switch on the ignition by turning the key to the right until the red and green warning lights in the speedometer come on. Then operate the starter without delay by turning the key further to the right.

When starting a warm engine, depress the accelerator pedal slightly. At low temperatures and when engine is cold, depress pedal fully, then release it before switching on the ignition. This enables the automatic choke device to close the choke valve.

In cold weather the engine and transmission oils tend to become thick. Therefore, you should also declutch when starting so that the starter motor has to turn only the engine. Do not race the engine when it is completely cold.

Non-repeat ignition lock

If the engine does not start within the first 10 seconds, pause for about that length of time to rest the battery before repeating the starter operation. The ignition will have to be switched off first and then on again as a non-repeat lock in the switch prevents the starter from being operated repeatedly when the ignition is on and thus being damaged by the engine when it is running.



start the engine

Put it into first and off you go

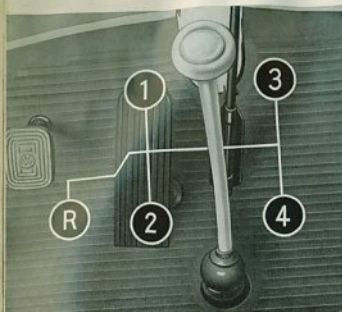

Starting off

Depress the clutch as far as possible.

Shift to the first gear and release the hand brake.

Engage the clutch by allowing the pedal to return slowly, and simultaneously depress the accelerator pedal. The vehicle will start to move forward.

Gradually increase the pressure on the accelerator pedal and remove your foot completely from the clutch pedal, as the clutch is now fully engaged.

To shift to the high gears

Take your foot off the accelerator pedal, simultaneously depressing the clutch pedal. Shift gear lever into the next position.

Engage the clutch gently by gradually taking your foot off the pedal, and at the same time depress the accelerator pedal, as before.

To downshift to a lower gear

If you are driving in slow city traffic or wish to downshift as you approach a curve or steep incline, release the accelerator pedal and depress clutch pedal.

Shift to the next lower gear.

Release clutch pedal and depress accelerator pedal.

Note that because of the Volkswagen's synchromesh gears, you do not need to come to a complete stop to shift into low.

To shift into reverse

Reverse gear should never be engaged unless the vehicle is at a standstill. To engage the reverse gear from neutral, press straight down on the gear shift lever and move it to the left and rearward.

Speed ranges for shifting

Upshifting

- first gear 0 to 15 mph
- second gear 6 to 28 mph
- third gear 12 to 46 mph
- fourth gear 20 to 65 mph

Downshifting

- fourth to third 46 to 20 mph
- third to second 28 to 12 mph
- second to first when barely moving.

Do's and Don'ts of shifting

A few tips from professional drivers and automotive service experts may make shifting easier for you (and may save you a few dollars in repair bills).

Do not over-rev the engine in neutral or in gear. On the other hand you should not labor the engine by driving too slowly in any gear.

Do downshift in plenty of time to keep the engine at the best rpm.

Do use the ball of the foot, not the toe or heel when clutching.

Do not rest your foot on the clutch when driving. When you stop temporarily and are in neutral, take your foot off the clutch pedal.

Do not rest your hand on the gear shift lever.

Do not "slip" (partially disengage) the clutch in slow traffic or on a hill. Downshift and take your foot fully off the clutch pedal.

1st gear



2nd gear



3rd gear



4th gear



And off you go ...

Economical operation is one of the outstanding features of your Volkswagen. However, squeezing a few extra miles from each gallon of gas depends largely on your manner of driving.

To apply the gas, depress the accelerator pedal gradually and only to the extent necessary to reach the desired speed. Flooring the pedal rapidly does not substantially improve acceleration but results only in increased fuel consumption and jerky starts.

For highway driving, maintain a steady and moderate speed when possible. You will find that the Volkswagen, as any other vehicle, is easier to drive at approximately $\frac{3}{4}$ of the top permissible speed for any given gear. And your gas mileage may surprise you.

Slow down gradually by gently pumping your brakes. Suddenly jamming on your brakes can only be justified as a final resort in an emergency as it can cause a collision from the driver in back of you. It can also cause locking of the wheels and loss of control.

You should slow down, and downshift if necessary, just before approaching a sharp curve, not too far in advance or while negotiating that turn. Downshifting before going down a steep hill will add a measure of safety as well as preserving your brakes.

You watch the road, the flashing lights will watch the Volkswagen

Green arrows

The green arrows at the top of the speedometer show that the turn signal indicators are blinking. They will automatically shut off when your turn is completed.

Green light

When you turn on the ignition the green oil pressure light will go on. This light should go out when the engine is started and the oil pressure increases. If it does not go out in a few seconds or if it lights up while you are driving, stop immediately and investigate.

(See page 35 in the Trouble Shooting Guide.)

Red light

As above, this light, which simultaneously controls the generator and cooling system, will come on when the engine is idling or the ignition is switched on. The light should go out as the clutch is engaged and the engine speed increased. If it does not, damage can be caused by further driving of your Volkswagen.

(See page 35 in the Trouble Shooting Guide.)

Blue light

The high beam of your headlights can be blinding to on-coming drivers. The blue light will tell you when you should depress the headlight dimmer button.



You can park in a Volkswagen-size parking space

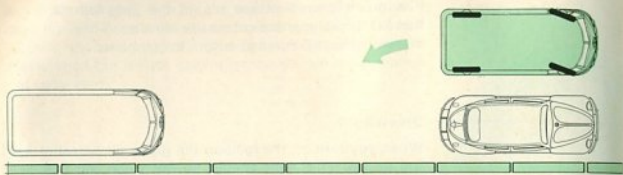

When curb (parallel) parking, stop with your rear wheels level with the rear wheels of the vehicle in front of the space. Turn the steering wheel sharply to the right and back your vehicle slowly into the gap.

When you just clear the vehicle ahead of you, turn the steering wheel fully to the left, and back up further toward the curb.

Now turn the steering wheel to the right again and pull up a little bit until your Volkswagen is centered between the cars in front and in back of you.

When parking on a steep grade, turn the wheels toward the curb and set the hand brake to prevent the vehicle from rolling. As a precautionary measure, it is advisable to engage first or reverse gear in addition to the hand brake. (When you park on the level, however, be sure to leave the vehicle in neutral. This will prevent damage to the transmission should another car bump into your parked Volkswagen.)

Ice and snow...

Brakes. At the beginning of the cold season, the guide tubes of the brake cables should be thoroughly lubricated with cold-resistant grease. See your Authorized VW dealer.

Door locks. Locks can freeze up in the winter, especially if water gets into the lock cylinder. A frozen lock can be opened by warming the key before insertion and then squirting anti-freeze into the lock cylinder.

Chains. If you do not install snow tires you should use chains when the roads are heavily covered with snow. Have the chains adjusted to the wheels if you wish to avoid loss of time and inconvenience later on. When driving on long stretches that are free from snow, the chains should be removed to avoid unnecessary wear of both chains and tires.

The battery. There is greater strain on the battery in winter than in warmer seasons because of the increased consumption of current when starting the engine and using the lights earlier in the evening. Also it is characteristic of any battery that its efficiency decreases at lower temperatures. If the vehicle is used mostly over short distances, the battery may require additional recharging. Have the battery checked often during the winter, and make sure that the ground connections and cables between battery and starter are clean.

The accelerator, clutch and heating cables, and the adjusting nut for the clutch cable should be checked for freedom of movement at the beginning of winter, and if necessary, cleaned and greased.



... you will go!

Spark plugs. The normal gap is .028". In extremely cold weather reduction of the gaps to .016" to .020" will aid starting considerably.

Engine oil. If temperatures below freezing are expected, use SAE 10 W oil, which may remain in the engine until the next regular oil change. If you add oil between regular changes, SAE 10 W oil may be used in cold weather and SAE 30 oil when it's warmer. Different viscosity grades can be mixed but be sure to use the same brand and type of engine oil.

If your Volkswagen is used mostly for short distances, especially when it's cold or dusty, have the oil changed at more frequent intervals, say every 1,500 miles. Under extremely cold conditions change every 750 miles.

In areas where below -13° F temperatures prevail, use SAE 5 W; change every 750 miles, and clean oil strainer at the same time. Caution: Avoid sustained speeds above 55 miles per hour when using SAE 5 W oil.

Transmission Oil

The SAE 90 oil can generally be used all the year round. It need only be replaced by the thinner SAE 80 grade in countries with arctic climates.



Once in a while it also needs water

Washing your vehicle. Wash your new Volkswagen frequently during the first weeks.

Soak the exterior finish of the body and wheels with water, then remove dirt with a sponge. Clean the sponge frequently to avoid scratching the finish. Rinse the body thoroughly to remove all soap or cleaner. After washing, rub down with a clean chamois to prevent water spots, and wax.

Waxing. Waxing will restore to the finish certain important properties it may have lost by exposure to the weather or in washing. A special preservative (L 190) for the finish of your Volkswagen can be obtained from your VW Dealer. The body should be waxed every eight to ten weeks — in any case, after each soap or detergent washing, as already mentioned. Follow directions on the preservative container.

Polishing. You should polish your Volkswagen only if its appearance has been strongly affected by road dust, sunlight and rain, when the application of the preservative no longer restores the original lustre. Avoid the use of abrasives or chemically harmful products, even if their first application seems to give satisfactory results. A special polish (L 170) for treating the synthetic-resin finish is also obtainable from your VW Dealer.

Before polishing, the car must be washed and dried carefully. Apply polish with a soft cloth, using straight horizontal or vertical strokes. Soon you will feel a slight resistance indicating that the ingredients of the polish have settled into the finish and the solvent has evaporated. Rub body with a clean cloth until the high gloss is restored,

Never wash, wax or polish the vehicle in sunlight.

Tar spots. An unpleasant sight, to be noticed particularly on light-colored vehicles, are tiny tar spots, which are picked up on hot days when driving on newly tarred roads. Tar can corrode the finish within a short time and should be removed immediately. Use gasoline, kerosene or turpentine then wash with a mild, lukewarm soap solution and rinse.

Insects are caught especially during the night, in hot weather, by the front end of the vehicle. Once baked on they are very difficult to remove with water and sponge, but should be treated with lukewarm soap solution.

Parking under trees. In the summer, trees often spot cars parked under them. These spots can be removed easily if washed immediately with detergent and warm water. Apply a coat of wax afterwards.

Cleaning sunroof. The plastic sliding roof does not require any special attention. It is, however, essential to clean the top regularly. When very dirty it should be cleaned with a detergent solution or a normal plastic cleaner. A hand brush can be used to clean the grained surface of the top but take care that the brush does not scratch the paint at the edges of the sliding roof. After cleaning, the top should be rinsed thoroughly with clear water.

Spots can be removed by wiping briefly with a gasoline-moistened cloth, then washing with a luke warm detergent solution. The spots should not be removed with paint thinner, chlorine base spot removers or similar solutions as these will attack the plastic material.

Chromium plated parts. All chromium plated trim should be treated, when dry, with a special VW chrome cleaner called Chromlin. Apply thinly and allow to dry for 10 minutes before polishing with a dry cloth.

Care of the upholstery. Clean leatherette upholstery with a soft cloth or soft brush taking special care to remove dust and dirt from the seams. Best results can be obtained by using a soft whisk broom and suds of any mild soap (castile or olive oil base) in lukewarm water (rain, boiled, or soft water). Use the water sparingly, as the upholstery otherwise requires a long time to dry if water trickles through the stitches. Soaked-in spots can be removed by carefully using a rag moistened with gasoline or alcohol. Spots caused by shoe polish can be removed by means of turpentine. Use these agents carefully and sparingly. After cleaning use a soft clean cloth to polish the surface of the leather. Never use solvents such as trichlorethylene or paint thinner or furniture polishes, oils, varnishes or cleaners on leatherette upholstery. They will injure the finish.

Cleaning Glass. Windows can be cleaned by washing with warm water and wiping dry with a clean, soft linen cloth. To facilitate this task on the windshield, the arms of the windshield wipers may be tilted forward. To clean exceptionally dirty windows, use alcohol or household ammonia and lukewarm water.

Windshield wiper blades. The rubber wiper blades should also be wiped clean with a detergent and soft cloth. The blades should be replaced if they are worn.

Touch-up pencils. VW paint touch-up pencils, in perfect-match colors, are available from your Authorized Volkswagen Dealer for retouching small scratches.

Here is what to do when trouble troubles you

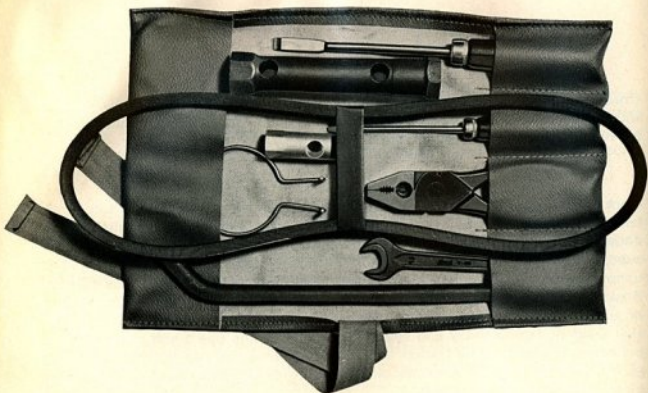

Your Volkswagen, when it receives regular preventive maintenance, should repay you with completely trouble-free driving. However, any complex mechanical device is subject to everything from the weather to premature and undetected wear on any of its parts.

Should you ever encounter difficulty starting your engine or have trouble on the road there are a few simple repairs which you can make to get your VW going again. Locate the **PROBLEM** and **PROBABLE CAUSE** of your trouble in the Guide on the following five pages and follow the directions on **WHAT TO DO**.

If the trouble is serious or you are uncertain as to its origin be sure to see an Authorized VW Dealer as soon as possible.

PROBLEM

I. VW will not start: engine will not turn over or turns over too slowly.

PROBABLE CAUSE

1. Poor internal contact in switch.

2. Loose connection.

A. At ignition switch.

B. At battery or starter.

C. At light switch.

D. At fuse box.

3. Dead or run down battery, as indicated by dim headlights.

WHAT TO DO

1. Jiggle key in ignition switch as temporary cure.

2. Make sure that all connections are tight.

A. Check connections at switch behind dashboard.

B. Check both cable connections on battery and grounded end of ground strap.



Check connections at solenoid, mounted on starter under right rear of vehicle.

C. Check connections at back of light switch.

D. Check connections of wires at fuse box.

3. Check electrolyte level in battery. If low, replenish with water, preferably distilled. Have recharged at earliest opportunity. Push to start the vehicle (see page 37).

PROBLEM

II. VW will not start:
engine turns over.

PROBABLE CAUSE

4. Engine turns over too slowly.

5. No gas in tank.

6. Loose connection in ignition system.

7. Loose connection in primary circuit to coil.

A. If no spark at terminal No. 15, electricity does not reach coil from battery.

8. If spark at terminal No. 15, trouble may be in secondary ignition system.

WHAT TO DO

4. Take same action as indicated in paragraphs 2B and 4.

5. Check gas gauge.

6. Check for loose connection at coil, distributor and spark plugs, and that coil is tightly bolted to fan housing.

7. Turn on ignition. Remove wire from terminal No. 15 of coil (number in raised letters), hold it by insulation, and strike against fan housing or other ground, being careful of gasoline and its fumes.

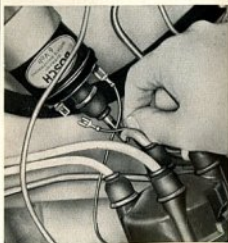

A. Check connections at choke, fuse box, ignition switch; also see paragraph 1.

8. Check for spark at plugs by pulling one connector off spark plug (pull on connector, not the wire), inserting short piece of wire or other

PROBLEM**PROBABLE CAUSE****WHAT TO DO**

conductor so that it projects beyond end of connector. Hold cable with cloth to avoid shock, so that wire is about $\frac{1}{4}$ " from engine cover. An alternative is to remove spark plug, clean and gap it (see page 68), reconnect to cable and lay plug on engine cover. Spark should jump when engine is turned over, preferably by starter.

9. If no spark at plugs trouble is in ignition system.

9. Wipe dirt and moisture from outside of distributor, coil, spark plugs and wires, and inside of distributor cap. Check that breaker points are opening and closing when engine turns over, and have the correct gap (see page 54). Check ignition timing (see page 54). Ignition should be retimed if point gap is changed.

10. If spark is fairly good at plugs, trouble is most likely in fuel system.

10. Check that gas is reaching carburetor by removing gas line from carburetor and placing free end in container. If gas runs from line, the fuel pump works. When cranking engine, preferably by starter, gas should spurt from line.

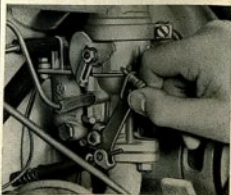

PROBLEM**PROBABLE CAUSE****WHAT TO DO**

11. If gas does not emerge and fuel pump is faulty or fuel strainer or fuel line from tank to pump is clogged.

11. Check for stoppage by removing gas line from fuel pump. Remove tank filler cap, blow through gas line and listen for bubbling sound in tank. See page 53 for cleaning fuel strainer.

12. If outside of carburetor is wet or there is a strong smell of gas, carburetor may be flooded, possibly caused by stuck choke valve or float needle valve.

12. Tap around outside of carburetor with piece of wood or plastic tool handle, wait 5 or 10 minutes, and try starter again with a fully depressed accelerator pedal.

13. Linkage stuck, air cleaner clogged.

13. Remove air cleaner elbow from top of carburetor and check that choke and all linkages are free to move.

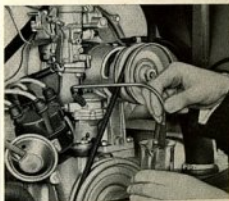

While elbow is off, remove air cleaner to make sure it is not clogged. Replace air cleaner and elbow before trying to start car again. With such symptoms frequently a push start, either by hand or by another vehicle will start the VW.

III. Engine runs, but frequently stalls or idles roughly.

14. Poor fuel supply.

14. Take action indicated in paragraphs 10 through 13.

These are your tickets for many thou

9. Steering adjustment.
10. Tire pressures, tighten
11. Brake system for damp
fluid in reservoir, foot
adjustment.
12. Battery, electrical sys
adjustment.

The Service Adviser (Out

During the roadtest:
Efficiency of braking, steering
systems. Overall performance.

After the roadtest:
Oil and brake fluid leaks, idling

WS 1

Lubrication Service 1500 miles

Having the Lubrication Services listed on the back of this coupon performed at this time at an Authorized Volkswagen Dealership assures you of the best possible preventive maintenance for your vehicle at the lowest possible cost.

Lubrication charges are at local rates.

PROBLEM**PROBABLE CAUSE****WHAT TO DO**

IV. Warning lights flash on while you are driving.

15. Incorrect idling mixture or idling speed adjustment.

15. See page 67.

16. If green light goes on the oil pressure is low.

16. Check oil level (see page 42). If it is below the bottom mark do not drive your Volkswagen until you have added oil. If the oil level is sufficient, contact your Authorized VW Dealer.

17. If red light goes on either the engine is overheating or the generator is not producing enough current.

17. Check the fan belt to see if it is broken or slipping (see page 52). Replace fan belt if necessary. If the fan belt is tight, you may drive to an Authorized VW Dealer.

How to change the wheels

While changing a flat is never a pleasant job, it will be somewhat easier and safer if you follow these instructions. Remember, if you are changing a wheel at the roadside be sure to turn on your Safety Flasher lights.

The spare wheel is stowed in the cab behind the bench seat and is secured with a retaining bracket and wing nut. To take the wheel out, just tip the seat forwards.

1. Set the hand brake securely and chock the wheels on the opposite side of the one to be removed to prevent the vehicle from shifting off the jack.



2. Insert jack into the square jacking port nearest to the flat tire, and turn the hexagonal nut until the base of the jack touches the ground.

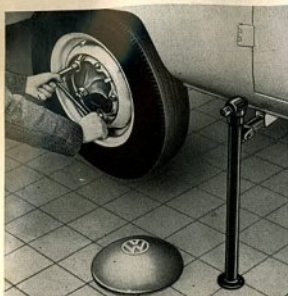

7. When reinstalling the spare, operate the jack until the five holes in the wheel are nearly lined up with the holes in the brake drum.



3. Remove hub cap with hub cap removal tool.
4. Loosen wheel bolts with the socket wrench while the wheel is still on the ground.
5. Raise vehicle until tire clears ground.
6. Remove wheel bolts and take off wheel.

8. First, insert one wheel bolt only. Tighten it enough to allow the wheel to be swung around this point by hand, until the remaining holes in the wheel and brake drum coincide.
9. Insert and tighten the remaining bolts until the self-aligning heads of the five bolts are centered in the corresponding recesses of the wheel.
10. Tighten every other wheel bolt in turn.
11. Lower the vehicle. To release jack insert handle into socket on side of jack and depress, forcing downward on trigger. Remove the jack and make sure that all bolts are tight.
12. Replace the hub cap firmly and make sure it is secure. Remove chocks.

ands of carefree miles

1500 miles
3000 miles
3000 miles
12000 miles
15000 miles
19000 miles
21000 miles
24000 miles
27000 miles
30000 miles

The Service Booklet contains more than just numbered tickets. It contains a plan to keep your Volkswagen troublefree, operating economically and maintaining its high resale value. The coupons will tell you when to have your car lubricated, the oil changed, and when it's time for a regular check-up. And the stubs become a documented record of the excellent care your VW has received. To introduce you to VW Preventive Maintenance we have made the first two coupons "on the house" — your vehicle gets a free check-up at 300 and 3,000 miles.

There is, throughout the United States and Canada and 130 foreign countries, an extensive network of Authorized VW Dealers, staffed with well-trained and experienced men, and supplied with all the special tools and equipment required to service your vehicle properly. If you should ever need service when you are away from home, look for the well-known Service Sign. The workshop displaying this sign is your assurance of the same expert, prompt, and courteous service you are accustomed to receiving at home. In case you can't get to an Authorized VW Dealer in time, we are giving you some information which, if needed, will help you to carry out normal maintenance work. However, difficult repair jobs which are beyond your experience should be performed by the nearest VW Dealer. There your Volkswagen will be given expert treatment by those familiar with such jobs.

This will save you time, inconvenience and money.

How to push it and how to pull it

Pushing (to start). Turn the ignition key to the ON position, with the gears in neutral. After the pushing vehicle has left the Volkswagen free rolling and the VW has reached a speed between 15 and 20 mph shift into third gear and slowly let out the clutch. Never attempt to start your Volkswagen by towing it with another car.

Towing. Place your Volkswagen in neutral (be sure hand brake is released) when it is being towed. Normally the vehicle should be towed forward with the tow chain or rope attached securely to the front torsion bar tubes. If the front wheels are lifted off the ground, as by a tow truck, attach rope to the torsion bar tubes and then wrap once around the front bumper.

If the transmission is damaged, your Volkswagen will have to be towed backwards with the rear wheels off the ground. Attach tow rope to the rear torsion bar tubes, then wrap once around the rear bumper. Since the front wheels will be on the ground be sure to secure the steering wheel tightly with the wheels in a straight-ahead position

Rocking (to free). If your Volkswagen should ever become stuck in snow or mud you may be able to free it by rocking the vehicle back and forth. Rock it as far rearward as you can, then hold it there by rapidly applying the hand brake. Shift into third and take the vehicle as far forward as you can.

Repeat this back and forth movement as long as it seems feasible. If your Volkswagen has a tendency to move either in a forward or rearward direction (should you be stuck on an incline) it will be best to rock the vehicle only in third gear or reverse.

Lubrication service

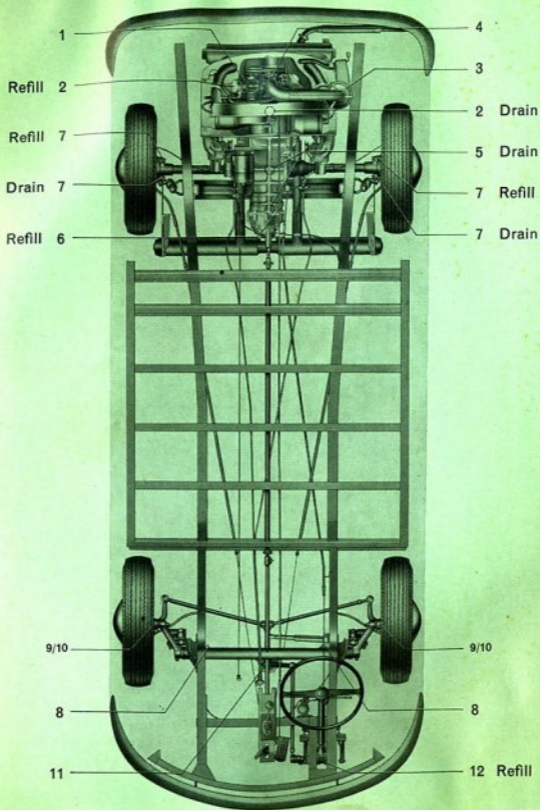

Lubrication Chart

Initial Lubrication			Subsequent Lubrication				Reference		Lubrication Points
At 300	At 1,500	At 3,000	Every 1,500	Every 3,000	Every 15,000	Every 30,000			
			x					1 M	Engine: Check oil level
x	x	x		x				2 M	Engine: Change oil, clean oil strainer
		x		x				3 M	Air Cleaner: Clean and refill
x		x		x				4 M	Carburetor Linkage: Lubricate
	x	x						5 G	Transmission: Clean magnetic drain plugs
	x	x		x				6 G	Transmission: Check oil level
x					x			5/6 G	Transmission: Change oil, clean magnetic drain plugs
x					x			7 G	Reduction Gears: Change oil
x	x	x		x				8 F	Front Axle Tubes: Lubricate fittings
x	x	x		x				9 F	King pins: Lubricate fittings
x	x	x		x				10 F	Link pins: Lubricate fittings
x	x	x		x				11 F	Swing Lever Shaft: Lubricate fitting
x		x		x				12 G	Steering Gear: Check oil level
x		x		x				13 F	Door and Hood locks and hinges: Lubricate
						x		14 W	Front Wheel Bearings: Repack

Lubricants

Lubricant	Lubrication Points	Specification
Engine oil HD for "Service MS"	Engine, oil bath air cleaner, carburetor linkage, felt ring in contact breaker base plate, door hinges	M SAE 30 above 32° F
		SAE 10 W below 32° F
		SAE 5 W below -13° F
Transmission oil hypoid	Transmission, reduction gear cases	G SAE 90 all the year*)
	Steering gear case	G SAE 90
Universal Grease	Torsion bars, king pins, link pins, swing lever shaft, door and hood locks	F Anti-freeze, water repellent
Lithium Grease	Front wheel bearings, breaker arm fiber block	W Multi-purpose

*) SAE 80 all the year in countries with arctic climates

1. Engine: Check oil level

The oil level can only be checked with the engine shut off. The oil level is satisfactory when it is between the two marks on the oil level dipstick, but **it should never be permitted to drop below the lower mark.** To make an accurate check, it is best to wipe the dipstick with a clean rag beforehand.

Select an HD oil (for Service MS) of a well-known and dependable brand right at the beginning, and stick to it. Further hints regarding engine oil changes are given in the section "Ice and snow ... you will go" on page 25.

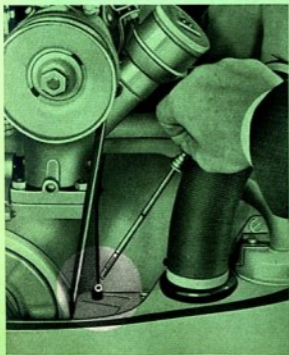

2. Engine: Change oil, clean oil strainer

Regular oil changes are necessary even if the very best branded oils are used. Diluted and dirty oil in your engine means greater strain and shorter life for your engine. On the other hand, provided that HD oil (for service MS) is used and your Volkswagen is driven under normal conditions, it is unnecessary and uneconomical to change the oil more frequently than called for in the lubrication chart.

The oil is drained, when warm, by removing the plug in the oil strainer bottom plate. Flushing of the engine is unnecessary, but the oil strainer should be removed and cleaned at every oil change. The two gaskets must be renewed each time.

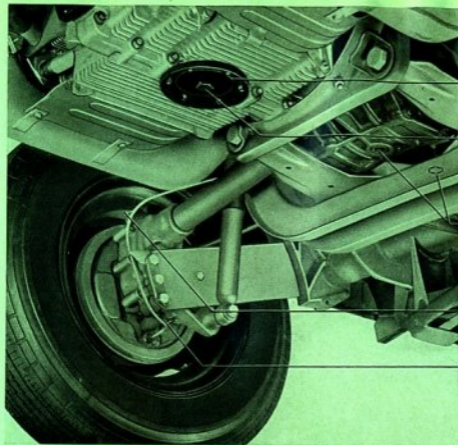

Oil Strainer
with cover

Oil Drain Plug
for crankcase

Magnetic Oil Drain Plugs
for rear axle and transmission

Oil Filler Plug

Oil Drain Plug
for reduction gears at rear wheels

The engine is refilled with
5½ pints of HD oil

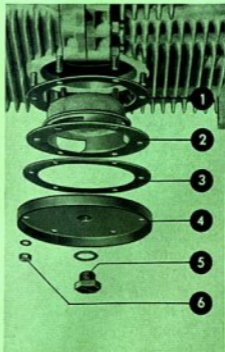

- 1 — Gasket
- 2 — Oil strainer
- 3 — Gasket
- 4 — Bottom plate
- 5 — Oil drain plug and seal
- 6 — Nut and lock washer

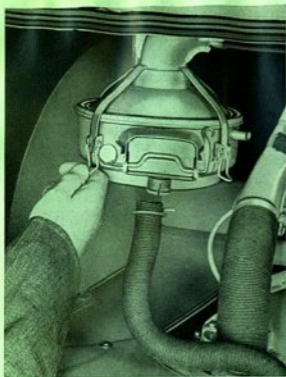

3. Air Cleaner: clean and refill

The air cleaner filters particles of dirt and grit from the air used for combustion. Regular attention should be given to its maintenance. A dirty air cleaner reduces the performance of the engine and increases fuel consumption.

The oil bath air cleaner should be cleaned every 3,000 miles. Remove lower portion from the intake elbow. Remove dirty oil reservoir, wipe clean and refill with SAE 20 engine oil up to the mark.

The filter element should be rinsed in fuel, kerosene, or any other degreasing solution and then dried.

If the vehicle is operating mainly in heavily dust-laden atmospheres, service the air cleaner more frequently than specified above to prevent premature wear. The air cleaner must, in any event, always be cleaned if there is no thin oil above the sludge at the bottom of the oil reservoir.

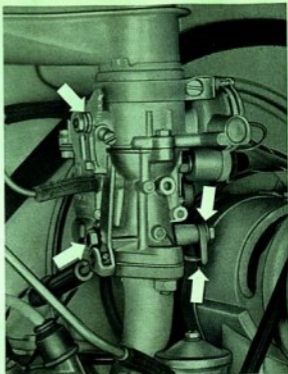

4. Carburetor linkage: lubricate

Oil all joints in carburetor linkage.



5. Transmission: check oil level, clean magnetic drain plugs

The transmission and differential gears are combined in the transmission case, therefore share a common oil supply. Timely oil changes have a beneficial effect on the smooth running of the gear trains.

The magnetic drain plugs should be thoroughly cleaned at 300, 1,500 and 3,000 miles and then at every transmission oil change. As the plugs can only retain a limited amount of deposits, the intervals for cleaning should be strictly adhered to particularly during the gear running-in period. At 1,500 and 3,000 miles the plugs should be removed one at a time and the holes blocked temporarily. The oil level should then be checked and oil added if necessary. The oil should be level with the edge of the filler hole.



6. Transmission: change oil

Drain the old oil shortly after running the Volkswagen, (so it will still be at operating temperature) by removing the magnetic drain plugs. Refill with 5 $\frac{1}{2}$ pints of hypoid oil. Wait a few minutes until oil has settled, then fill to capacity.

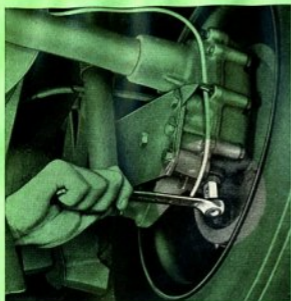

7. Reduction Gears: change oil

Each reduction gear case should be drained and refilled with $\frac{1}{2}$ pint of the same oil which is used in the transmission oil change, and should be performed at the same intervals.

8. Front Axle Tubes: lubricate fittings

The four fittings of the axle bearing points can be greased properly only if the front axle is raised so that the vehicle weight is taken of the wheels.

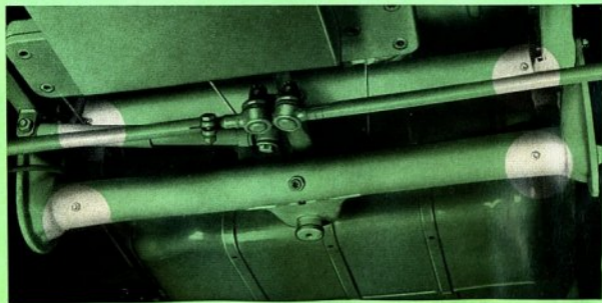

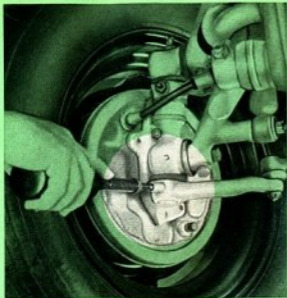

9/10. King Pins and Link Pins: lubricate fittings

The fittings on king pins and link pins should be greased every 3,000 miles.

If the vehicle is frequently driven over bad roads it is advisable to grease the king pins in between the normal lubrication services, i.e. every 750 to 1,500 miles. Before greasing, the nipples should be wiped clean to prevent dirt from being forced into the bearings. Do not allow grease to get on the brake hoses or tires, as grease and oil will corrode rubber. Even small amounts should be removed immediately.

Check the dust seals of the maintenance-free tie rod ends for damage at every lubrication. Damaged seals should be renewed as soon as possible.



11. Swing Lever Shaft: lubricate fittings

Proper lubrication of the swing lever shaft is essential to steering ease and safety.



12. Steering Gear: check oil level

The steering assembly should be lubricated exclusively with SAE 90 hypoid oil and under no circumstances with grease or any other oil. The level of the oil in the steering case should be kept at the lower edge of the filler plug hole.



13. Door and Hood locks and Hinges: lubricate

The door lock striker plates should be very lightly greased. Apply a few drops of oil to the lid hinges. The door hinges should be oiled at every lubrication.



Door cylinder locks should be treated with graphite. Dip the key into the graphite, insert key and move it back and forth several times.

14. Front Wheel Bearings: repack

Front wheel bearings are packed with grease at the factory. The caps on the front wheel spindles should be free of grease after repacking.

The front wheel bearings are to be cleaned and repacked with grease every 30,000 miles. The brake drums must be removed for this purpose. The bearings must be adjusted after repacking. It is recommended that this job be performed only by your Authorized VW Dealer.

Driver's Seat

The upper and lower surfaces of the runners for the driver's seat should be greased lightly to ensure the desired freedom of movement. The runners should be cleaned with a rag before the grease is applied.

What lubricants should be used?

It is left to your discretion to select an oil of a well-known and dependable brand of the proper viscosity to suit your seasonal and driving requirements. In cases of doubt, refer to your authorized VW Dealer who will be glad to help you with your lubrication problems. It is recommended that you select "your" brand and type of oil right at the beginning and stick to it at all future oil changes.

The requirements of the VW engine are met by all commercial brand HD oils. Viscosity of the lubricant is an indication of its resistance to flow at a given temperature. The SAE numbers classify lubricants in terms of viscosity, for example: SAE 20 W, SAE 10 W etc. Outside air temperature is decisive for the selection of the SAE grade to be used.

SAE 30 is suitable for all temperatures above 32° F.

SAE 10 W should be used in the winter when it is expected that the temperature will fall below 32° F.

SAE 5 W is used only in arctic climates, where the temperature falls below -13° F.

CAUTION: Avoid sustained speeds above 55 mph when using SAE 5 W oil.

Where the API (American Petroleum Institute) Classification applies the HD oils suitable for the VW engine are referred to as "For Service MS".

Multigrade oils are HD oils which cover several viscosity grades, such as SAE 10W/30 for example. These oils are also suitable for VW engines and can be used both in summer and winter.

Additives should not be mixed with HD oils.

For additional information on the proper lubricants to use during cold weather see page 25.

These vouchers guarantee you a complete maintenance job

W 10

Lubrication and Maintenance Service **6 000** miles

Having the Lubrication and Maintenance Services listed on the back of this coupon performed at this time at an Authorized Volkswagen Dealership assures you of the best possible preventive maintenance for your vehicle at the lowest possible cost.

Lubrication and Maintenance charges are at local rates.

6 000 miles

Maintenance Chart

At 300	At 3,000	Every 3,000	
x	x	x	Check Fan Belt Tension
x	x	x	Clean Fuel Pump Filter
x	x	x	Clean Contact Points, Adjust Point Gap and Adjust Ignition Timing
x	x	x	Adjust Valve Clearance
x			Check Engine and Rear Axle for Leaks
x	x	x	Adjust Clutch Pedal Free-Play
x			Tighten Nuts and Bolts on Chassis, Body, Engine, Front and Rear Axles, and Steering
x	x	x	Adjust Steering
x			Check and Adjust Front Wheel Bearing Play
x	x	x	Check and Adjust: Torsion Arm Link Pins, Tie Rod Ends and Dust Seals, Steering Damper Mounting, and Toe-in
x			Check Tire Pressures and Wheel Bolts for Tightness
x	x	x	Check Brake System for Damage and Leaks, Adjust Foot and Hand Brakes, Check Brake Fluid in Reservoir
x	x	x	Check Acid Level and Specific Gravity of Battery
x	x	x	Check and Adjust Complete Electrical System and Headlights
x	x	x	Check Efficiency of Brakes, Steering and Heating System
x	x	x	Adjust Idling
	x	x	Check Compression, Clean and Gap Spark Plugs
	x	x	Check Exhaust Systems for Damage
	x	x	Check Tires for Wear and Damage, Adjust Tire Pressures
	x	x	Check Thickness of Brake Linings through Inspection Hole



1. Check and adjust fan belt

Checking tension. The V-belt drives the generator and the fan. **Perfect condition and correct tension ensure long belt life and adequate engine cooling.**

Checking is very simple: when pressed with the finger the belt should give between $\frac{1}{2}$ and $\frac{3}{4}$ inch (dimension a).

If you find any sign of wear, such as frayed edges, see your Authorized VW Dealer. In spite of its long life there should always be a spare belt in the vehicle.

Adjusting and replacing the Fan Belt.

To adjust or replace the fan belt, remove nut and outer half of generator pulley. When loosening or tightening nut, insert a screwdriver in the slot in the inner half of the pulley and support it against the upper generator housing bolt. The adjustment of the fan belt tension is effected by means of spacer washers situated between the two pulley halves. Belt slackness is taken up by removing one or more washers. If the belt is too taut,

one or more washers should be added. Store extra adjustment washers on the shaft between nut and outer pulley half.

The fan belt should not be too slack, nor should it be too tight. Newly installed belts will stretch to some extent and should, therefore, be checked and adjusted at 300 miles. Further adjustment is not necessary as the tension will not change.

Always keep a new fan belt in the vehicle.



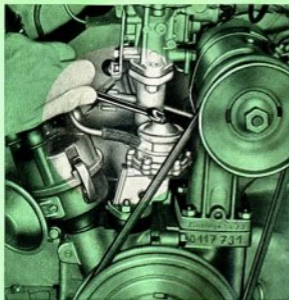

2. Check and Clean Fuel Pump Filter

The fuel pump filter prevents foreign matter and dirt from entering the carburetor.

The filter should be cleaned at the prescribed intervals.

1. Install clip on fuel hose between tank and engine compartment.
2. Remove fuel pump cover screw and take off cover.
3. Remove filter and wash in solvent. (When installing the filter do not forget the gasket for the cover.)

3. Ignition Timing

Particular attention must be paid to correct ignition timing. In many cases poor performance, high fuel consumption and even damage to the engine can be the result of incorrect ignition setting. The ignition must not be advanced arbitrarily under any circumstances.

Before setting the ignition timing, the breaker contact point gap must be checked. The ignition timing must be set when the engine is cold.

Clean Contact Points

The contact points must be smooth and make even contact with each other. Dirty contacts should be cleaned and, if pitted, smoothed with a contact file. While you are doing this the contact points are pressed lightly together. Afterwards the ignition distributor should be blown out carefully with air. If the points are badly burnt they should be replaced.

Lubricating Ignition Distributor

The breaker arm fiber block in the ignition distributor should always be lubricated with Lithium grease. Every 3,000 miles check whether this location must be cleaned and provided with new grease. Only a very small amount of grease should be used and none of it must come in contact with the breaker points as otherwise the ignition will be affected. Every 3,000 miles, one drop of oil must be applied to the breaker base plate felt ring.

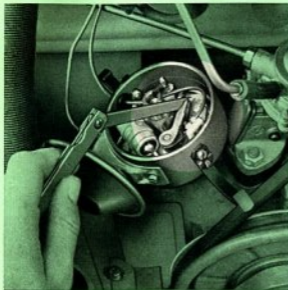

Adjust Point Gap

Remove distributor cap and rotor. Turn engine until the breaker arm is fully lifted by a cam lobe.

Loosen breaker point screw.

Place a screwdriver between the two lugs on the breaker plate and the slot in the fixed point and adjust points gap to .016". Tighten screw and install rotor.

After adjusting contacts, adjust the ignition timing.

Adjust Ignition Timing

Turn the engine clockwise until the right hand mark on the crankshaft pulley (10° before top dead center) is aligned with the crankcase joint and the rotor arm is pointing to the Number 1 cylinder mark on the edge of the distributor housing.

Loosen distributor bracket clamp bolt. Connect one lead of 6 volt test lamp to the primary terminal on the distributor and the other to ground.

Switch on ignition.

Turn distributor clockwise until the points are closed and then turn counter-clock-



wise slowly until the points just begin to open and the test lamp lights up.

Tighten clamp bolt.

The timing is correct if the test lamp lights up at the moment the right hand mark aligns with the crankcase joint when the engine is turned slowly clockwise. The engine should be turned back about 1/2 turn beforehand to take up the play in the distributor drive.

4. Adjust Valve Clearance

The valves should be adjusted only when the engine is cold. The clearance for intake and exhaust valves is .012".

To ensure that the valves are fully closed when adjusting, the piston concerned must be at TDC on the compression stroke. The cylinder arrangement is shown by the embossed number on the engine cover plates. The adjusting sequence is 1, 2, 3, 4.

Remove distributor cap.

Turn engine until the right hand mark on the crankshaft pulley is aligned with the crankshaft joint and the rotor arm points to the Number 1 cylinder mark on the edge of the distributor housing.

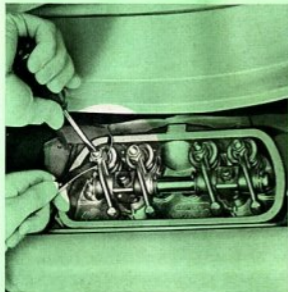

Remove cylinder head covers.

Loosen lock nuts of adjusting screws for valves of Number 1 cylinder.

Adjust clearance to .012" with the feeler gauge.

Hold clearance screws and tighten lock nuts.

To adjust valves on cylinders 2, 3, and 4, turn the engine counter-clockwise until rotor has moved 90° for each cylinder.

5. Check Engine and Rear Axle for Leaks

Drive the Volkswagen for a short distance before checking this. Also make sure that the valve cover gaskets are sealing properly.

6. Adjust Clutch Pedal Free-Play

Easy gear shifting and complete transmission of engine output to gears and wheels can only be guaranteed if the clutch is adjusted as specified.



Measured at the clutch pedal this free play should be $1/2''$ to $3/4''$ (a). The clearance can be adjusted with the adjusting nut at the rear end of the cable.

1. Release lock nut on the threaded cable end.
2. Adjust clutch clearance by turning the adjusting nut. Depress clutch pedal several times and recheck pedal free-play.
3. When the correct adjustment has been reached, hold adjusting nut in position and tighten lock nut.
4. Grease clutch cable adjusting nut with universal grease.

... Adjust Foot Brakes

If brake pedal play is found to be excessive, and visual inspection indicates that the linings are not badly worn, the brakes should be adjusted. You should then proceed as follows:

1. Remove hub caps.
2. Jack up the vehicle and turn the wheel to be adjusted until the hole in the brake drum is in line with one of the adjusting nuts.
3. Insert a screwdriver through the hole and turn the adjusting nut in the direction indicated by the arrows until a light drag is noted when the wheel is turned by hand.
4. Repeat procedure on the other adjusting nut. Note that the two nuts turn in opposite directions.
5. Back off the adjusting nuts by 3 to 4 teeth until the wheel turns freely.
6. Repeat the above operations on the other wheels.
7. Replace hub caps securely.

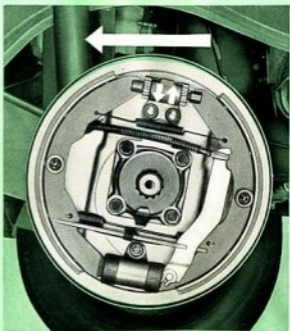
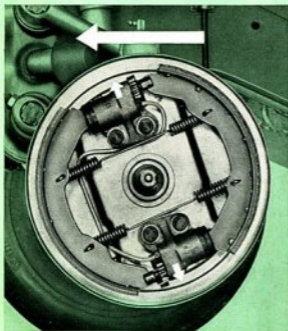

When adjusting the rear wheel brakes, the hand brake must be released. It is advisable to depress the brake pedal sharply before and after adjusting the brake shoes to ensure brake shoe centering, i.e. the proper position of the shoes relative to the brake drum.

7. Tighten Nuts and Bolts on Chassis

Check tightness of all bolts on chassis, body, engine, front and rear axles, and steering.

8. Adjust Steering

In the straight-ahead position there should be no steering wheel play and the front wheels should resume their straight-ahead position after the vehicle has taken a turn. All steering adjustments should be performed only by an Authorized VW Dealer.

9. Front Wheel Bearing Play

It is recommended that this operation be performed by an Authorized VW Dealer, as maladjustment may cause severe damage to the roller bearings. If circumstances

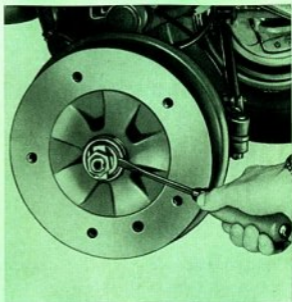

require removal of a front brake drum, the front wheel bearings are to be adjusted as follows:

Tighten inner nut until the thrust washer can just be moved laterally with a screwdriver and no bearing play can be felt when rocking the brake drum.

Finally, secure the nuts by bending down the lock plate.

10. Check and Adjust: Torsion Arm Link Pins

The torsion arm link pins should be checked and, if necessary, re-adjusted every 3,000 miles. The front end of the vehicle should be raised so that the weight is taken off the wheels.

Checking

Rock the wheel by hand to check for end play between torsion arm link and torsion arms. If play is present, adjust torsion arm link pins.

Adjusting

1. First grease torsion arm link pins thoroughly.
2. Back off pinch bolts at torsion arm eyes.
3. Fully tighten link pins first, then back off about $\frac{1}{8}$ of a turn.



4. Tighten the torsion arm link pins until the resistance of the shoulder making contact can be felt.
5. Tighten the pinch bolts again.

If the range of adjustment is insufficient, the shims are worn and should be replaced by an Authorized VW Dealer. After pins have been adjusted, it is absolutely necessary to check the toe-in.

...Tie-Rod Ends and Dust Seals and Damper

If play is found to be appreciable have correct adjustment done by a Authorized VW Dealer.

...Toe-in

With the empty vehicle on the ground, front wheel toe-in should be $0^{\circ} \pm .04^{\circ}$ and with maximum permissible gross weight it should be $.08^{\circ}$ to $.20^{\circ}$. These dimensions can be accurately checked only with a track tester at an Authorized VW Dealer. Fractional deviations can wear the tires quickly and reduce road holding qualities.

...Adjust Hand Brake

Always adjust the foot brake before checking or adjusting the hand brake. The hand brake needs adjustment if the Volkswagen's rear wheels are not locked when the hand brake lever is in the fourth ratchet notch.

1. Jack up both rear wheels.
2. Push hand brake boot upwards.
3. Tighten adjusting nuts of the brake cables to a degree which will still allow the rear wheels to turn freely when the hand brake is released.
4. Pull up hand lever two notches and make sure both rear wheels have the same braking effect. At the fourth notch it should be impossible to turn the wheels by hand. Lock adjusting and counter nuts. Push brake boot back in place.



...Check Brake Fluid in Reservoir

The brake fluid reservoir should be at least $\frac{3}{4}$ full.

The reservoir is accessible after lifting the inspection plate in the floor of the cab.



11. Check Tire Pressure and Wheel Bolts for Tightness

Recommended inflation pressure for tires is as follows: front tires — 28 pounds per square inch; rear tires and spare — 33 pounds per square inch.

12. Check Brake System for Damage and Leaks

Even barely visible leaks in the hydraulic system will be reflected in brake pedal play. If play is excessive the brake lining wear should be visually checked through the inspection hole in the brake drum. If the 3,000 mile maintenance shows that the linings are badly worn (a thickness below .090"), the brakes must be relined. Relining should be done by your Authorized VW Dealer

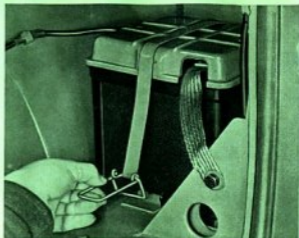

13. Check Acid Level and Specific Gravity of Battery; Clean and Grease Terminals

The battery should be checked with a cell tester. This is a voltmeter in parallel with a heavy resistance. The voltage of each cell should not fall below 1.6 volts while taking the reading (10—15 seconds). Otherwise the cell is discharged or defective. Under no-load conditions each charged cell should read 2 volts.

Add distilled water to each cell to bring the level just above the plates. The acid level has to be adjusted in accordance with the acid level mark. Losses by evaporation may be replenished by adding distilled water. Never add acid, unless it is known that acid has been spilled from the battery. Check specific gravity afterwards and compensate if necessary.

Clean terminals and outside of battery with a cloth, or if badly corroded, use bicarbonate of soda, being careful not to get any inside the battery. Coat the clean posts and terminals with light grease to prevent corrosion. Then tighten securely and make sure that there is a proper connection to ground.

When storing your vehicle for a prolonged period, it is advisable to take the battery to a workshop for storage. A battery which is not in constant use will discharge itself in time and this can result in permanent damage to the plates if the battery is not checked about every 4 weeks and charged as necessary.

14. Check and Adjust Complete Electrical System

Check Fuses

The fuse box, with transparent cover, is located below the parcel shelf. When a fuse has blown out, it is not sufficient merely to replace it with a new one. Inspect the electrical system for evidence of short circuits or other faults which may have caused the fuse to blow. Under no circumstances should you use a fuse patched up with tin foil or wire because this may result in severe damage. We suggest that you carry with you several spare 8 amp. VW fuses.

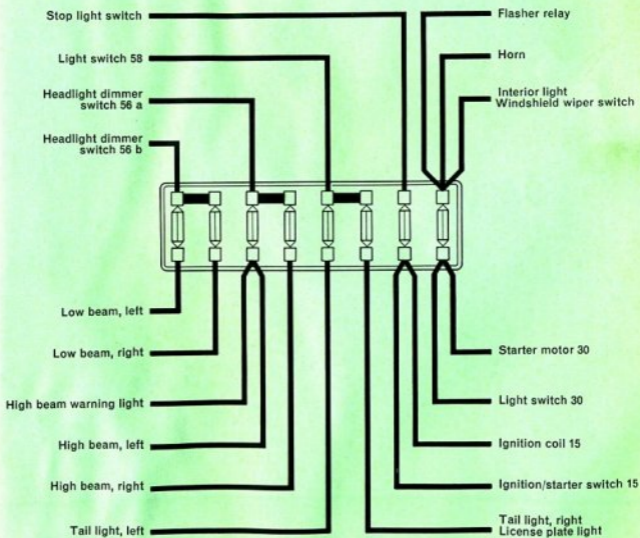

After checking all lights, signals and horn, aim the headlights. It is best to check the headlight alignment on a regulation screen. If no headlight aiming device is available proceed as follows:

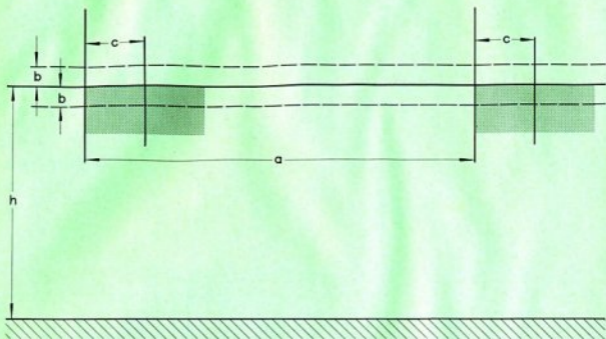

(Chart measurements: $b = 2''$ $c = 6''$ $a = 39\frac{1}{2}''$)

h = Height of headlight centers from ground

1. Adjust tires to correct pressures and park vehicle on level surface squarely facing a wall or screen 25 feet in front of the headlights.
2. Measure height (h) of center of headlights from ground and draw a horizontal line on screen at this height the full width of the vehicle.
3. Opposite the center of each headlight, draw a vertical line intersecting the horizontal. These lines should be $39\frac{1}{2}$ inches apart. Drawing a vertical line for the center of the vehicle might help aligning vehicle with screen.
4. Turn headlights on low beam.
5. The high intensity portion of the low beam of each headlight should be positioned so that its upper edge is even with the horizontal centerline and its left edge is even with the vertical counterline. The upper edge of the beam may not be higher or lower than 2 inches from the horizontal centerline. The left edge of the beam may not be left of the center line or to the right of it by more than 6 inches.

6. Independent adjustment of each headlight for both horizontal and vertical aim is effected with the adjustment screws in the front of the headlight rim as shown below.

Check with your State Bureau of Motor Vehicles for variations from these dimensions.



Adjustment	Headlamp: right	left
Vertical	lower screw: clockwise - raises anti-clockwise - lowers	upper screw: anti-clockwise - raises clockwise - lowers
Horizontal	upper screw: clockwise - to right anti-clockwise - to left	lower screw: clockwise - to right anti-clockwise - to left

Replacing Sealed Beam Unit. A double filament, type 2, seven inch sealed beam unit of domestic manufacture is used in your Volkswagen. Should it become necessary to replace the unit, unscrew the large slotted screw in headlight rim and remove housing from vehicle. Pull wire plug from back of unit and disconnect the parking light wires. Remove clips from behind sealed beam, which can now be removed from housing. Installation is reverse of this procedure. After reassembly re-aim headlights.





Replacing Front Turn Indicator Bulb.

Remove two Philips screws and take off lens and rubber gasket. Press bulb lightly into holder, turn and remove. Replace bulb. When replacing make sure the gasket is properly seated all around, insert lens and tighten screws evenly, but do not overtighten. Do not touch metal reflector with hands, as this can corrode the surface.



Replacing License Plate Bulb.

Pull off rubber cap, press spring in holder towards bulb and remove holder. Replace bulb. Make sure that the holder contact springs are clean and that they have sufficient tension for secure bulb contact.



Replacing Rear Turn Indicator Bulb.

Remove two Philips screws and take off lens and rubber gasket. Press bulb lightly into holder, turn and remove. Insert replacement bulb. As with the front turn indicator, be sure the gasket is properly seated, then replace lens and tighten the screws evenly.

Replacing Warning Light Bulb

The warning lights for oil pressure, generator charging, flashing indicators, head-light main beam as well as the speedometer and gas gauge lights are accessible from under the instrument panel. The bulb sockets can easily be removed.

15. Check Efficiency of Brakes, Steering and Heating System

Note any deficiencies which show up during the road test and make the proper adjustments.

16. Adjust Idling

The carburetor is tested at the factory and properly adjusted to the engine. Do not alter this adjustment by exchanging the jets for other than the prescribed sizes. This would be detrimental under normal operating conditions, and many result in hard starting, excessive fuel consumption or unsatisfactory engine performance.

Only the idle setting may require occasional adjustment. Before attempting to adjust the carburetor, make sure the engine is at normal operating temperature.

Also check that the idle adjustment screw is on the lowest step of the fast idle cam in the automatic choke.

1. Turn the idling adjusting screw (1) in or out until normal idling speed is attained (about 550 rpm) this speed is reached just as the generator warning light goes out.
2. Gradually turn the volume control screw (2) to the right until the idling speed drops, then back it off a $1/4$ to $1/3$ turn in to the left.
3. Finally re-adjust the idling speed.

1

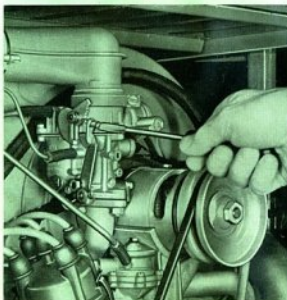

2



The adjustment is correct if the engine does not stall when the throttle is either suddenly opened or shut with the clutch pedal depressed. Poor idling may also be the result of damaged gaskets, loose intake manifold flanges, faulty ignition or leaky valves. Checking and adjustment of the carburetor, automatic choke and the accelerator pump should be left to an Authorized VW Dealer, who has the experience necessary for such adjustments.

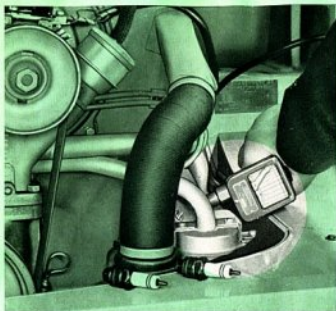

17. Check Compression

After warming up the engine, remove all 4 spark plugs. Operate the starter motor with the throttle wide open. The compression is checked by inserting an accurate compression gauge into the spark plug hole of each cylinder.

Result: good	128 to 142 lbs./sq. in.
satisfactory	100 to 128 lbs./sq. in.
poor	below 100 lbs./sq. in.

... Clean and Gap Spark Plugs

Remove the spark plugs and check their exterior. The appearance of electrodes and insulators provides considerable information on engine adjustment and condition.

Electrodes and insulator

- medium grey — good adjustment of carburetor and correct performance of spark plug,
- black — mixture too rich,
- light grey — mixture too lean,
- oiled up — misfiring or piston ring blow-by.

Cleaning spark plugs is best accomplished with a spark plug cleaning machine. If none is available you should wire-brush the electrode end of the plug and blow it out with an air hose. The rest of the plug should be wiped with a clean cloth and solvent. The insulator should be clean and dry on the outside in order to avoid short circuits or tracking. Check the electrode gap (.028") and reset if necessary by bending the outer electrode. Use gasket when installing the plugs.

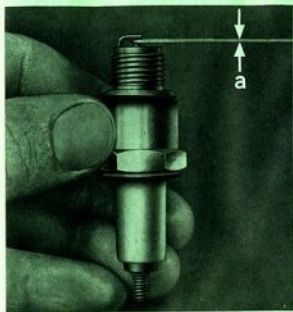

[(a) = .028"]

Generally speaking you may count on a spark plug service life of up to 10,000 miles.

18. Check Exhaust Systems for Damage

The entire length and all connections of the exhaust system should be visually checked even for the tiniest pin-hole. One method of checking the exhaust system is to cover the ends of both exhaust pipes and turn on engine. If the system is functioning properly the engine should stall.

Because of the possibility of escaping carbon monoxide fumes this important check should be made by an Authorized VW Dealer.

19. Check Thickness of Brake Lining through Inspection Hole

If visual inspection reveals that linings are badly worn refer to page 59.

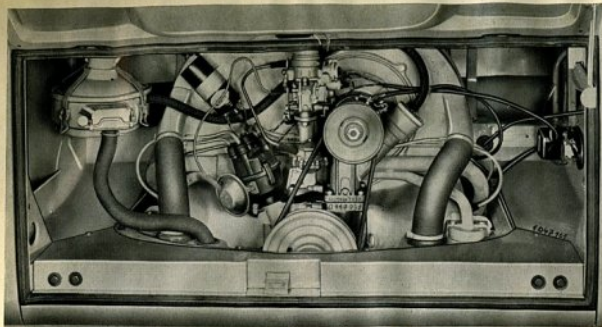

How your Volkswagen works

ENGINE

The engine, located in the rear of the vehicle, is attached by 4 bolts to the recessed flange of the rubber-mounted transmission. Two pairs of cylinders are horizontally opposed. Each pair has one common cylinder head made of a light magnesium aluminium alloy. The overhead valves are located in the cylinder head and are operated from the camshaft by means of push rods, cam followers and rocker arms. The short crankshaft rests in four main bearings and is heat-treated at its four points of support. It drives the camshaft by means of helical gears. The connecting rods are fitted with lead-bronze bearings. The pistons are made of light alloy.

A downdraft carburetor produces the fuel and air mixture to supply the cylinders. The engine is equipped with battery ignition. The spark advance is controlled automatically by a vacuum mechanism.

The oil pump of the full pressure lubrication system is driven by the camshaft and draws the oil from the crankcase through a strainer and pumps it to the various lubrication points via an oil cooler. In cold weather, when the oil is thicker, an oil pressure relief valve makes it possible for the engine to be lubricated directly, that is, by avoiding the oil cooling system.

The air cooling of the engine is done by means of a fan, which is attached to the extended generator shaft and driven by a V-belt. The generator pulley is adjustable to permit adjustment of belt tension. The fan draws in air through an opening in the fan housing, and the air cools the engine by passing through the cylinder fins. A thermostat controls and regulates the amount of cooling air and ensures well-balanced operating temperatures.

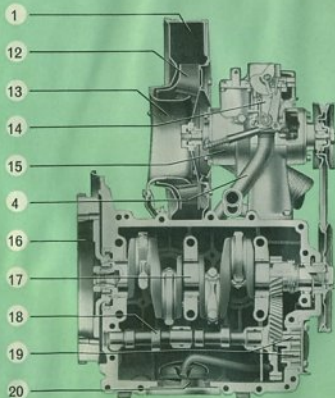
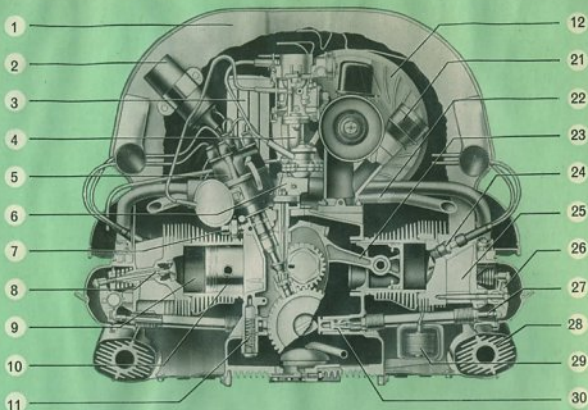

ENGINE

- 1 - Fan housing
- 2 - Ignition coil
- 3 - Oil cooler
- 4 - Intake manifold
- 5 - Distributor
- 6 - Fuel pump
- 7 - Oil pressure switch
- 8 - Valve
- 9 - Cylinder
- 10 - Piston
- 11 - Oil pressure relief valve
- 12 - Fan
- 13 - Throttle ring
- 14 - Carburetor
- 15 - Generator
- 16 - Flywheel
- 17 - Crankshaft
- 18 - Camshaft
- 19 - Oil pump
- 20 - Oil strainer
- 21 - Oil filler and breather
- 22 - Pre-heating pipe
- 23 - Connecting rod
- 24 - Spark plug
- 25 - Cylinder head
- 26 - Rocker arm
- 27 - Push rod
- 28 - Heat exchanger
- 29 - Thermostat
- 30 - Cam follower

TRANSMISSION AND FINAL DRIVE

Power from the engine is transmitted to the gears via a single-plate dry clutch. The transmission provides four speeds forward and one reverse. All models are equipped with a synchromesh transmission. The gears are helically cut to provide silent operation. The drive pinion and the ring gear of the rear axle are also helical. The two rear swing axle shafts pivot at the differential housing. Spur wheel reduction gears are provided on the outer ends of the rear axle tubes.

AXLES AND STEERING

The front axle consists of two rigidly joined tubes containing the torsion bars and the suspension arms. The front wheels are sprung independently. The suspension arms form parallelograms assuring proper steering and suspension geometry under all driving conditions. Stops with rubber buffers are provided to prevent excessive rebound.

The steering gear, which is of a worm and rolling stud type, actuates the steering arms of the independent suspension by a draglink and a divided tie rod.

The rear axle is of the swinging half-axle type. The rear wheels are also independently sprung by means of adjustable round steel torsion bars. Double acting hydraulic shock absorbers of the telescope type in front and rear control wheel movement.

The hydraulic foot brake operates on all four wheels; the hand brake acts only on the rear wheels through cables.

BODY

The body is of a unitized, all-steel design, provided with a strengthening frame to support the axles. The position of the load space within the wheelbase ensures an even distribution of the load on all four wheels. The loading compartment is accessible through a double-wing door from the side and through a hinged rear panel. The tarpaulin of the Pick-up as well as the bows which are fastened to the platform by means of a few screws can easily be removed and replaced. The driver's compartment for 3 persons offers exceptional driving visibility. Ventilation is through vent wings and sliding windows in addition to an overhead fresh air regulator.

HEATING

The air drawn in by the fan is warmed by the heat exchangers. The warm air then passes along a tube in the center of the vehicle into the cab through an adjustable outlet at foot level and two defroster vents at the windshield. On the VW Station Wagons the passenger compartment is also heated by outlets under the rear seat. The heating is regulated by a knob which is operated from the driver's seat.

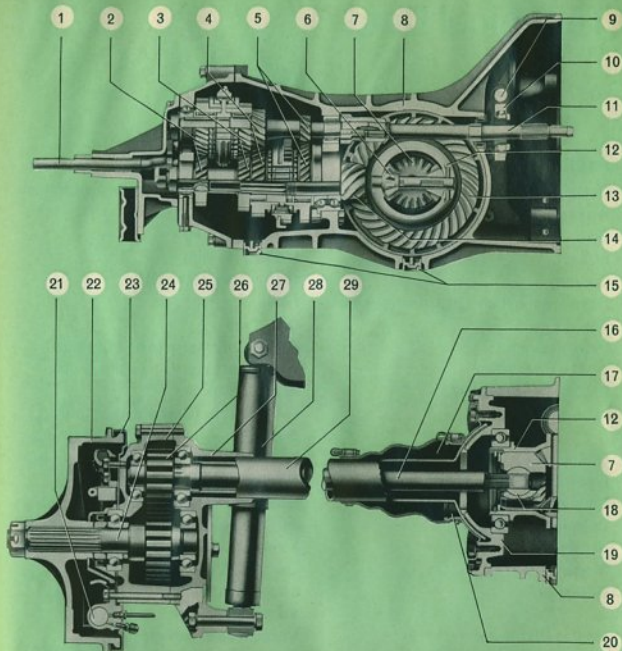

REAR AXLE AND TRANSMISSION

- | | | |
|-----------------------------|-------------------------------|--------------------------------------|
| 1 - Selector shaft, inner | 12 - Differential housing | 21 - Wheel brake cylinder |
| 2 - 4th gear | 13 - Ring gear | 22 - Brake drum |
| 3 - 3rd gear | 14 - Drive pinion | 23 - Brake back plate |
| 4 - 2nd gear | 15 - Magnetic oil drain plugs | 24 - Reduction driven gear and shaft |
| 5 - 1st gear | 16 - Rear axle shaft | 25 - Reduction gear case cover |
| 6 - Differential pinion | 17 - Dust sleeve | 26 - Reduction drive gear |
| 7 - Side gear | 18 - Fulcrum plate | 27 - Reduction gear case |
| 8 - Transmission case | 19 - Final drive cover | 28 - Telescopic shock absorber |
| 9 - Clutch operating shaft | 20 - Rear axle tube retainer | 29 - Rear axle tube |
| 10 - Clutch release bearing | | |
| 11 - Main drive shaft | | |

Technical Data

ENGINE

Design	4 Cylinder, 4 Stroke, in Rear of Vehicle
Arrangement of Cylinders	Horizontally Opposed
Bore	3.27 ins. (83 mm)
Stroke	2.72 ins. (69 mm)
Capacity	91.10 cu. ins. (1493 cc)
Compression Ratio	7.8:1
Valves	O. H. Type
Valve Clearance	Intake .012 ins. } to be adjusted when Exhaust .012 ins. } engine is cold
Brake Horsepower (SAE)	50 HP at 3900 rpm
Lubrication	Full pressure (Gear Pump with Oil Cooler)
Oil Capacity	5.3 Pints (4.4 Imp. Pints)
Fuel Pump	Mechanical Type
Carburetor	Downdraft Type Solex 28 PICT
Cooling System	Air Cooling by Fan, Thermostat controlled
Battery	6 Volts, 77 Ampere Hours
Starter	Electric, 6 Volts, .6 HP
Generator	6 Volts, 200 Watts at 2600 rpm with Voltage Regulator
Ignition Distributor	Vacuum spark advance
Firing Order	1—4—3—2
Spark advance	10° before T.D.C.
Breaker Point Gap	.016 ins.
Spark Plugs	14 mm thread Beru 175/14, Bosch W 175 T 1, Champion L 85, or other spark plugs of correct heat range
Spark Plug Gap	.028 ins.
Clutch Design	Single Disc, Dry
Clutch Pedal Free-Play	$\frac{3}{4}$ ins.

TRANSMISSION

4 Synchronized Forward Speeds, 1 Reverse

Gear Ratios

First: 3.80:1

Second: 2.06:1

Third: 1.22:1

Fourth: (Manually operated overdrive):
0.82:1

Reverse: 3.88:1

REAR AXLE

Power is transmitted through a helically-cut drive pinion and ring gear, via two swinging axles and spur gear reduction drives to the rear wheels.

Ratio

4.125:1

Refill Oil Capacity of Transmission and

Rear Axle

5.3 Pints (4.4 Imp. Pints)

REAR WHEEL REDUCTION GEARS

Ratio

1.26:1

Oil Capacity of Reduction Gear Cases

0.53 Pint (Imp. 0.44 Pint)

CHASSIS

Suspension, Front

Suspension, Rear

Shock Absorbers

Steering

Turns of Steering Wheel, Lock to Lock

Turning Circle

Foot Brake

Hand Brake

Two Laminated Torsion Bars

Two Solid Torsion Bars

Double-Acting Telescopic Type, Front
and Rear

Ross type cam and lever steering gear
with rolling stud contact and hydraulic
steering damper

2.8

about 39 Ft.

Hydraulic, Operating on all 4 Wheels

Mechanical, Operating on Rear Wheels

Wheels	4 1/2 K x 15, Drop-Center Type
Tires	6.40 — 15
Inflation Pressure	Front: 28 lbs./sq. in. Rear and Spare: 33 lbs./sq. in.
Wheel Base	94.5 ins.
Track (Tread)	Front: 54.1 ins. Rear: 53.5 ins.
Toe-in (Vehicle empty)	0 ± .04 ins.
(Vehicle fully loaded)	.08 — .20 ins.

DIMENSIONS AND WEIGHTS

	<u>Standard Station Wagon and Kombi</u>	<u>De Luxe Station Wagon</u>
Length	168.5 ins.	169.3 ins.
Width	68.9 ins.	70.9 ins.
Height	76.4 ins.	76.4 ins.
Ground Clearance	9.4 ins.	9.4 ins.

LOAD SPACE (seats removed)

Mean Length	106.3 ins.
Mean Width	59.1 ins.
Mean Height	53.1 ins.
Mean Capacity	170 cu. ft.

LUGGAGE COMPARTMENT

Mean Length	27.6 ins.
Mean Width	57.1 ins.
Mean Height	31.5 ins.
Mean Capacity	28 cu. ft.

WEIGHT IN LBS.

	<u>Payload</u>	<u>Unladen Weight</u>	<u>Gross Vehicle Height</u>	<u>Max. Seating Capacity</u>
Kombi	1643	2502	4145	8
Standard Station Wagon	1632	2513	4145	8
Deluxe Station Wagon	1632	2513	4145	8

Permissible axle loads in lbs. Front: 2094 Rear: 2238

Performance	65 mph
Climbing ability first speed	28%
second speed	14%
third speed	7.5%
top speed	4%

REFILL REQUIREMENTS

Fuel tank capacity	10.6 gallons (8.8 Imp. Gallons)
Engine	5.3 pints (4.4 Imp. Pints)
Transmission and rear axle	5.3 pints (4.4 Imp. Pints)
Reduction gear cases	0.53 pints each (.44 Imp. Pints)
Steering gear	0.53 pints (.44 Imp. Pints)
Brake system	0.63 pints (.53 Imp. Pints)
Fuel Consumption	25.0 mpg

The measured consumption is the actual consumption plus 10%, determined with half the permissible payload at a continuous $\frac{3}{4}$ of maximum speed (53 mph) on level road.

Oil Consumption	Approx. 1.7—4.8 pints per 1000 miles (1.4—4.0 Imp. Pints)
-----------------	--

DRIVING LIGHTS

Headlight	No. 6006 Type 2
Front Parking	No. 81
Front Turn and Safety Flasher	No. 1129
Tail, Turn and Stop	No. 1154
License	No. 81

Index

Accelerating	20	Engine: care in winter	25
Accelerator Pedal	15	description	70
Additives, oil	49	lubrication	42/43
Ash tray	13	number	80B
Axle loads	77	oil level	42
		oil strainer	43
		sectional view	71
		specifications	74
		type of oil	49
Battery: Maintenance	62	Engine compartment door	2
care in winter	24		
Body, description	72		
Brakes: adjusting	59-61	Fan belt: checking and adjusting	52
application	20	Foot brake, adjusting	60
care in winter	24	Fresh air regulator	11
checking	59-61		
description	72		
		Front axle: description	72
		Front wheel bearings: adjusting	58
		repacking	49
Carburetor: adjusting	67	Fuel consumption	77
type	74	Fuel pump, filter, cleaning	53
Chains, tire	24	Fuses, replacing	62
Chassis, care in winter	24		
Chassis number	80B	Gas gauge	13
Cleaning	27	Gear shift pattern	18
Climbing ability	77	Generator	70
Clutch: design	74	Ground clearance	76
pedal	15		
pedal free-play	56	Hand brake: adjusting	61
Controls and instruments	12	description	72
Cold weather hints	24	Headlights: aiming	64
Cooling of engine	70	changing unit	65
		Heater: description	72
		operation	15
Dimmer switch	14	Horn button	12
Door locks: care in winter	24		
lubrication	48		

Identification plate	80 B	Seats, removing and reversing	7
Idling, checking and adjusting	67	Shock absorbers, design	75
Ignition: breaker point gap	54	Spark plugs, care of	68, 69
firing order	74	Specifications, general	74
timing	54	Speedometer	13
Jack	36	Speed ranges for shifting	19
Keys	2, 3	Starting	16
License plate light, replacing	66	Steering: adjusting	57
Light switch	12	description	72
Lubrication	40	type	75
Lubrication chart, lubricants	41	Stoplight: bulb replacement	66
Lubrication points	40	Sunroof: cleaning	28
Maintenance chart	51	opening	11
Multigrade oils	49	Suspension	75
Oil consumption	77	Tires: inflation pressure	59
Oil Level: engine	42	Toe-in, adjusting	59
steering gear	48	Tool kit	80
transmission	45	Towing	37
Parking	22	Track (tread)	76
Pushing (to start)	37	Transmission: description	72
Ratios: rear axle and transmission	75	oil change	45
Rear axle: description	72	sectional view	73
reduction gear lubrication	46	Troubleshooting	31—35
sectional view	73	Turn indicator lever	12
Rocking	37	Turning circle	76
Safety flasher switch	12	Upholstery care of	29
Seat adjustment	6	Valves: adjusting	55
		arrangement	74
		Vent wing	11
		Warning lights	21, 35, 67
		Weights	77
		Wheelbase	76
		Wheels: changing	35, 36
		rim size	76
			79

Tools and Accessories that came with your VW Station Wagon

- 1 Fan Belt
- 1 Tool Roll
- 1 Spare Wheel
- 1 Jack
- 1 Hub Cap Removal Tool
- 1 Square Key
- 1 Combination Pliers
- 1 Screw Driver 0.8
- 1 Screw Driver 0.5
- 1 Socket Wrench 14 mm
- 1 Socket Wrench for Spark Plugs, Wheel Bolts, Pulley and Jack
- 1 Open End Wrench 8/12 mm
- 1 Tommy Bar (Mandrel) for Socket Wrench
- 1 VW Service Booklet

Reference Data Record

Serial Number _____ License Plate Number _____
Engine Number _____ Registration Number _____
Chassis Number _____ Taxable Horsepower _____
Ignition Key Number _____ Max. Gross Vehicle Weight _____
Unladen Weight _____

Personal

Name _____
Address _____
City _____ State _____ Phone _____

Insurance Company

Collision/Comprehensive _____
Liability _____

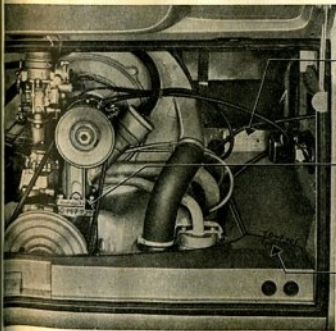

The Identification Plate
is found on the vertical surface to the
right of the engine.

The Engine Number
is located on the crankcase flange for
the generator support.

The Chassis Number
is stamped on the engine cover plate
near the battery.

