

2

# *Instruction Manual*



*Transporter*

M A Y 1 9 5 9

# INSTRUCTION MANUAL

# VW TRANSPORTER

## CONTENTS

Introduction .....	3
Controls and Instruments .....	5
Operating Instructions .....	9
Practical Driving .....	21
Cold Weather Hints .....	26
Lubrication .....	29
Wheels and Tires .....	38
Care of the VW Transporter .....	41
Maintenance .....	45
General Description .....	65
Technical Data .....	69
Bulb Data Chart .....	73
Lubrication Chart .....	75
Maintenance Chart .....	76
Index .....	77
Tools and Accessories .....	Inside Back Cover

VOLKSWAGENWERK GMBH WOLFSBURG  
Germany

# REFLECTOR AND W



We are sure that the excellent performance and economical operation of your VW Transporter will justify the confidence you have placed in our firm when purchasing this vehicle.

This Manual sets out in full the information necessary for the proper operation, care and general maintenance of your VW Transporter. In addition, interesting specification details have been included to familiarize you with the construction and mechanical details of this fine piece of mechanism.

No effort has been spared to produce an efficient and reliable automobile. This Instruction Manual can help you obtain lasting satisfaction in the operation of your VW Transporter. All information contained in this handbook is based on the actual experience of many years.

In order to maintain maximum efficiency, we particularly stress the importance of following the recommendations set out in this manual. The intimate knowledge obtained by studying this manual will assure you of the utmost service and satisfaction from your VW Transporter.

Regular attention to proper lubrication and maintenance of your vehicle is important. An extensive network of VW Dealers exists throughout the world, and you will readily recognize such stations by the familiar blue VW SERVICE sign. These Dealers are in constant contact with the Volkswagenwerk through our field engineers, thus providing skillfull and expert performance of any job to be done. You'll enjoy many more miles of trouble-free driving by giving your VW Transporter just ordinary care.

All experienced VW owners know the value of preventive maintenance. The efforts in regard to care and maintenance will be amply rewarded in the long run.

And now enjoy your VW TRANSPORTER!

V O L K S W A G E N W E R K G M B H



# CONTROLS AND INSTRUMENTS

The first thing you must do is become familiar with the controls and instruments of your new VW Transporter. Sit behind the wheel, make yourself comfortable, and get acquainted with all the various levers, switches and controls. Some of the features you may already know. Check your present knowledge against this complete list.

## ONLY ONE KEY

is required to operate door and rear panel locks, switch on the ignition, and operate the starting motor (1). It is advisable to record the key number and keep it with the vehicle documents. In the event of having lost the key, you can easily obtain a new one from your dealer by referring to the number.

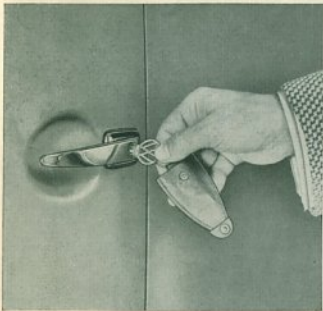

## INSTRUMENTS :

- 3 - Speedometer and odometer
- 2 - Warning light — Red — Direction indicators (diamond)
- 4 - Warning light — Green — Oil pressure
- 5 - Warning light — Blue — Headlight high beam
- 6 - Warning light — Red — Generator and cooling system

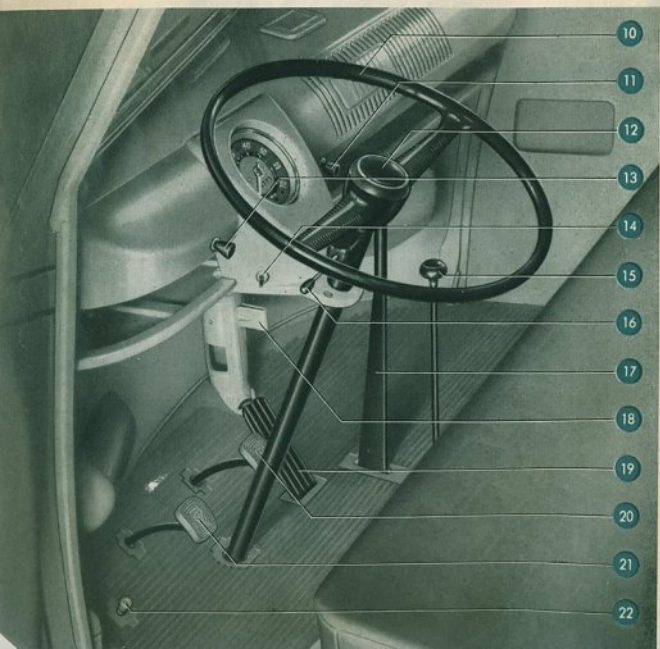
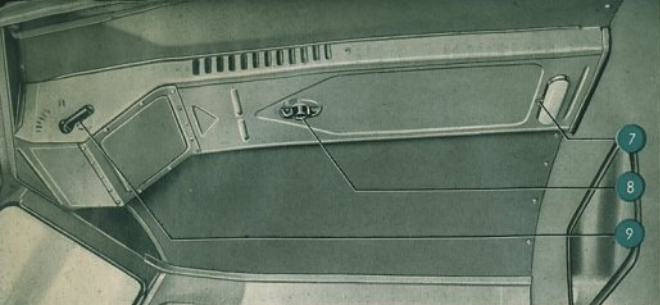



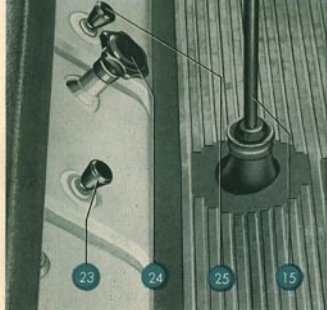

## HAND CONTROLS :

Combined ignition and starting switch (page 5) ...	1	Operating lever for fresh air regulator .....	9
Steering wheel .....	10	Fresh air deflector handle .....	8
Gear lever .....	15	Cab lamp switch .....	7
Hand brake lever .....	17	Heating control .....	24
Direction indicator lever .....	16	Choke control .....	25
Headlight and instrument light switch .....	11	Fuel tap operating knob (push-pull type) .....	23
Horn button .....	12	Inside door handle .....	27
Hot air distributor .....	18	Vent wing lock .....	29
Tumbler switch for cargo room lamp	14	Vent wing lock release button ...	28
Windshield wiper switch .....	13	Sliding glass panel catch .....	26

## FOOT CONTROLS :

Clutch pedal .....	21	Accelerator pedal .....	19
Brake pedal .....	20	Headlight dimmer switch .....	22

Among the papers which come with your vehicle you will find details regarding the mode of construction, and chassis and engine numbers. The Police or Traffic Department will check whether or not the information on the papers corresponds exactly with that on your vehicle.

**THE IDENTIFICATION PLATE**

is found on the vertical surface to the right of the engine.

**THE CHASSIS NUMBER**

is found to the right of the engine just below the identification plate.

**THE ENGINE NUMBER**

is stamped on the generator support.

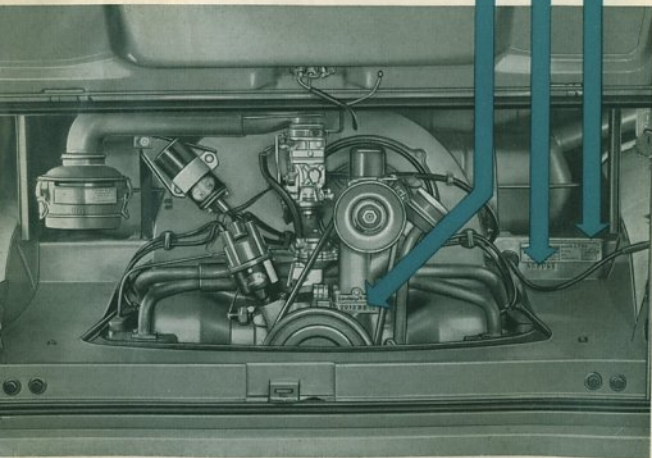



## OPERATING INSTRUCTIONS

### BEFORE YOU DRIVE AWAY

please check

- engine oil level
- fan belt tension
- quantity of fuel in the tank
- tire pressures
- efficiency of brakes
- position of rear view mirror

and, if driving at night  
or in foggy weather,

- the exterior lights



The engine compartment lid is opened by means of the square key delivered with the vehicle. The lid can be lowered by pressing against the horizontal bar of the check mechanism.

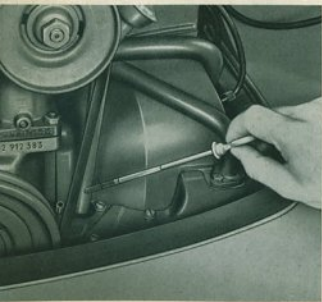

### ENGINE OIL LEVEL

The oil level should be checked with the engine at rest. The oil level is satisfactory when it is between the two marks on the oil level dipstick, but **it should never be permitted to drop below the lower mark.** To make an accurate check, it is best to wipe the dipstick with a clean rag beforehand.

Should it become necessary to top up, please remember the following hints: Most oils marketed at present contain chemical ingredients to improve their lubricating qualities. However, oils of

different origin behave differently when used as engine lubricants and should, therefore, not be mixed.

**Select a HD oil (for Service MS) from well-known and dependable brands right at the beginning, and stick to it!**

Further hints regarding engine oil changes are given in the Sections "Cold Weather Hints" and "Lubrication" on pages 26 and 29—31.

## FAN BELT

The V-belt drives the generator and the fan. **Perfect condition and correct tension of the belt insure its long life and adequate cooling of the engine.** Checking is very simple: the belt, when pressed with the finger, must yield **approximately 15 mm. [.6"]**. If you find any sign of wear, such as frayed edges, see your VW Dealer. In spite of the long life, there should always be a spare belt on the vehicle. Details are given on page 46.

$a = 15 \text{ mm. [.6"]}$

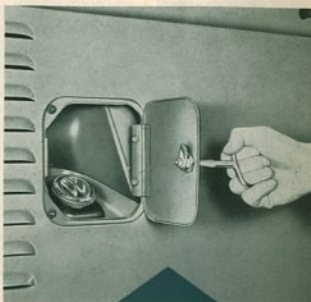
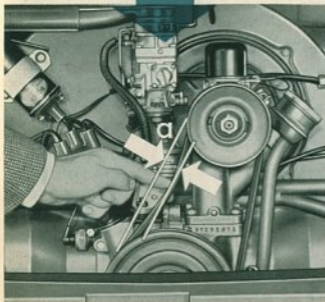

## FUEL TANK

The tank has a capacity of 40 liters (10.6 U.S. gals., 8.8 Imp. gals.), sufficient for a drive of approx. 400 kilometers (250 miles). The tank filler tube on the right-hand side of the vehicle is accessible by opening the cover with the square key delivered with the vehicle.



Positions of fuel tap:

- 1 - Open
- 2 - Reserve
- 3 - Closed

The fuel tap is operated by a push-pull knob from the driver's seat. Under normal conditions the knob should be pushed fully home. The tap is then in the open position.

If the engine begins to "stutter" as a result of lack of fuel, just pull the knob fully out to switch the tap to "reserve". A fuel reserve of 5 liters (1.3 U.S. gals., 1.1 Imp. gals.) will then last for a further drive of about 50 kilometers (30 miles). It is important to push the knob all the way in again when filling the tank, otherwise there will be danger of running out of fuel on the road. With the knob pulled out half its travel, the fuel tap is closed.

The VW Engine is so designed that it runs on all proven trade-mark fuels. Trade-mark fuels, including gasoline-benzol blends, comprise such characteristics as constant physical properties, sufficient anti-knock qualities and freedom from harmful ingredients.

**The selection of a grade and brand of fuel is therefore left entirely to your discretion.**

### THE TIRES

deserve and require your particular attention. A special section deals with the care of the tires on pages 38—40. The riding comfort and the roadholding of your VW TRANSPORTER will greatly depend on their condition. Maintaining correct tire pressure and avoiding driving abuses are the most important factors in obtaining maximum tire life. Check regularly and keep tires inflated to the following pressures:

Front .....	2.0 kg./sq. cm. (28 lbs. sq. in.)
Rear and spare wheel ..	2.3 kg./sq. cm. (33 lbs. sq. in.)

#### Ambulance

Front and Rear .....	1.8 kg./sq. cm. (26 lbs. sq. in.)
----------------------	--------------------------------------

Do not forget to replace the valve dust caps after this inspection.



## THE BRAKES

should be checked before you start on a trip by gradually pressing down on the brake pedal while the vehicle is in motion to be sure they are in good working order. The section "Apply the Brakes Gently" on page 17 deals with the correct application of brakes under various circumstances.

## GOOD EXTERIOR LIGHTS

are the first requirement of safe car operation at night. The three positions of the lighting switch are the following:

- 1 - Fully pushed in — Off.
- 2 - Pulled out to first stop — Parking light, tail and license plate lights.
- 3 - Fully pulled out — Headlight high or low beams (depending on position of foot dimmer switch), tail and license plate lights.

When pulling out the lighting switch knob either to the first or second stop, the instrument light is automatically turned on. By turning the knob a variable degree of instrument lighting is obtained, turning the knob to extreme left turns out the light entirely. When checking the lighting system, do not forget the two stop lights which should light up when depressing the brake pedal with the ignition turned on.

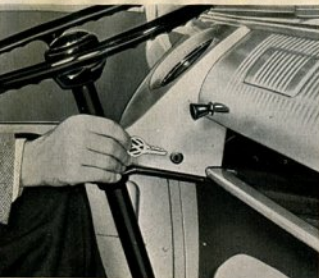

## STARTING THE ENGINE

is easy, because you are now familiar with the various controls and instruments. However, make sure that the gear lever is in neutral position before starting the engine.

The ignition key starting enables you to start the engine by merely turning the ignition key. First the ignition is switched on by turning the key to the right. The red generator warning light and the green light for the oil pressure will light up. To start the engine, the key is pressed against a spring load

and further turned clockwise until the starting motor operates. As soon as the engine fires, release pressure on key to disconnect starting motor.

**In cold weather, the transmission oil is apt to congeal. It is, therefore, good practice to declutch until the engine fires. Thus you will save the battery and facilitate the operation of the starting motor.**

**You will never encounter any difficulties when starting your engine in the coldest weather if you observe the rule of using the specified thin engine and transmission oil.**

### **To start cold engine,**

pull out the choke control knob and operate the starting motor until the engine starts.

In severe frost it is recommended to proceed as follows:

- a - Slightly depress the accelerator pedal several times.
- b - Fully pull out the choke control knob.
- c - Fully depress clutch pedal.
- d - Turn on the ignition and operate the starting motor.

Do not switch on any other electrical equipment. When starting with the choke pulled out, the accelerator pedal should not be depressed.

As soon as the engine starts, slowly push in choke control knob (about half way) until the engine runs smoothly and evenly at fast idle speed without a tendency to stall (it is inadvisable to race the engine immediately on starting up from cold).



This position of the choke control knob permits a quick moving off without any detriment to the engine. Neither will harm be done to the engine when you drive for a longer period in dense city traffic with the choke pulled out half its travel.

**As the engine attains operating temperature, you will notice an increase in the idling speed. At the same time gradually push the choke control knob all the way in.**

This position must be reached before you make use of the full engine power on a free road. If the engine does not start within ten seconds, just repeat the procedure a few times, allowing a short interval between each successive attempt, as the battery is being strained heavily by continuous starting motor operation.

To start the engine **when hot**, do not pull the choke control knob. **Slowly** depress accelerator pedal while operating the starting motor. Do not pump the accelerator pedal. **It is important to know that pumping the accelerator pedal makes a starting of the warm engine difficult and increases the fuel consumption.**

## **CAUTION!**

**Be careful when starting the engine inside your garage. See that the door and windows are open so that the exhaust fumes can escape. They contain the colorless, tasteless and odorless, yet extremely poisonous carbon monoxide gas.**

## **DRIVING THE VW TRANSPORTER**

is extremely easy, if you observe the following:

- 1 - Press down the clutch pedal as far as possible. Keep it in that position.**
- 2 - Shift to the first gear. Release the hand brake.**
- 3 - Engage the clutch by gently removing your foot from the pedal, while simultaneously pressing down the accelerator pedal. Your VW Transporter will start to move ahead.**
- 4 - Gradually increase the pressure on the accelerator pedal and remove your foot completely from the clutch pedal, as the clutch is now fully engaged.**

Shifting to second gear is equally simple:

- 1 - Take your foot off the accelerator pedal, while simultaneously pressing down the clutch pedal.**
- 2 - Shift gear lever into second position.**
- 3 - Engage the clutch by taking your foot off the pedal gently and gradually step on the accelerator pedal again.**

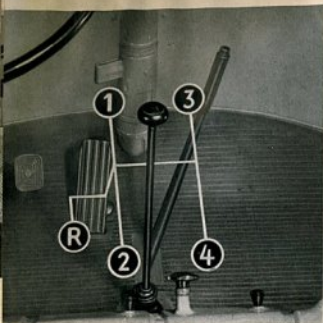

You now know how to "shift gears", and may at will shift to third and fourth positions. You will have noticed by now that the accelerator and clutch pedals are operated simultaneously, but in opposite directions. It is the coordination of these simultaneous operations that brings skill in shifting gears.

### THE REVERSE GEAR

should never be engaged unless the car is at a standstill. To engage the reverse gear, first press down the gear lever vertically, move it to the left and pull it rearwards.

### SHIFTING TO LOWER GEAR

This is what you should do in close city traffic, or with sharp turns ahead of you, or when driving up-hill.

- 1 - Release accelerator pedal and depress clutch pedal.
- 2 - Shift to 3<sup>rd</sup>, 2<sup>nd</sup> or 1<sup>st</sup> gear respectively.
- 3 - Release clutch pedal and step on accelerator pedal simultaneously.

Of course, this goes much more quickly in actual operation than by describing it here. We do not want to bore you with a technical discourse, but it may be of interest to you to know that, when shifting down, the synchromesh device assures meshing of the gears without clash, as the lower gear is synchronized so that both gears are turning at the same speed.

When shifting gears, it is absolutely necessary to depress the clutch pedal fully. Incomplete declutching makes gear shifting difficult and leads to rapid wear of the synchronizer stop rings.

To avoid undue strain on transmission and engine, shifting down should only be effected within the speed range of the lower gear i. e.

- from 4<sup>th</sup> into 3<sup>rd</sup> gear between 50 and 30 k. p. h. (30 and 20 m. p. h.) and
- from 3<sup>rd</sup> into 2<sup>nd</sup> gear between 30 and 20 k. p. h. (20 and 12 m. p. h.)

The 1<sup>st</sup> gear is only used for moving off, driving at walking pace, or on very steep inclines.

After a short period of practice, you will take pleasure in the correct handling and shifting of the gears and obtain the utmost satisfaction from the efficient performance of your new VW TRANSPORTER. Under no circumstances should you be afraid to shift to a lower gear, or even try to avoid shifting occasionally by merely letting the clutch "slip" in a partly disengaged position.

**Moreover, the clutch pedal should never be used as a foot-rest while driving your vehicle!**

### **APPLY THE BRAKES GENTLY**

The brake corresponds to even the slightest foot pressure. Increasing the pressure will progressively slow the vehicle down. However, do not jam on the brakes as this would result in skidding. The stopping distance will not be shortened by skidding but you may lose control over the movements of the vehicle and the tires will be exposed to heavy wear.

Here are a few rules on braking:

Use your brakes **before**, not **while** making a turn.

It is neither practical nor economical to shift to a lower gear far ahead of a turn. Do not hesitate to use the brakes and to shift shortly before entering the curve so that you may already accelerate while still negotiating it.

To jam on the brakes suddenly can only be justified when danger is ahead. Nevertheless, it is advisable to check the full braking efficiency from time to time to familiarize yourself with the reaction of the vehicle and with the actual stopping distance. Never forget first to have a look in the rear view mirror to make sure that no vehicle is following you and that your check will, therefore, not endanger anyone. Operate your brakes especially gently when the road is wet or covered with ice. Sudden braking of the wheels will result in skidding.

When driving down-hill, make use of the braking capacity of the engine compression by shifting to the gear which you would use in driving up-hill. You will attain a higher degree of safety and at the same time you will save and preserve the brakes if you use them only to control the speed occasionally. The ignition must never be switched off when descending gradients.

## STOPPING THE VEHICLE

Take your foot off the accelerator pedal and operate the brakes gently. Shortly before the vehicle comes to a full stop, release the clutch and place the gear lever in neutral position. The engine continues to idle.

If you wish to turn off the engine, merely switch the ignition key to the left.

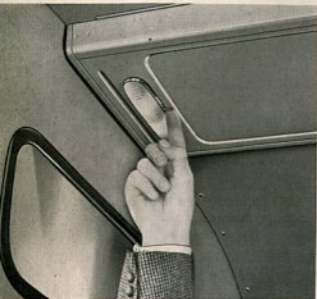

## THE INTERIOR LIGHT

of the cab is operated by a switch built-in with the lamp.

The light in the cargo room or passenger compartment is operated by the tumbler switch situated on the left-hand side of the instrument panel below the speedometer.

## BEDEWEED WINDOW GLASS

will greatly reduce visibility. It is caused by the high inside air humidity due to passenger breathing and by the lower ambient air temperatures. By opening the vent wings according to requirement, sufficient fresh air can be taken in and the used air drawn off. As a result, the glass will remain clear and driving will be greatly facilitated.

## THE FRESH AIR REGULATOR

above the windshield offers an efficient ventilation of both cab and cargo room or passenger compartment. The ventilation is turned on by means of the lever located at the left-hand side of the air guide channel. The air intake can be regulated by turning the lever to one of its five positions. With the lever in the

a - Fresh air regulator lever

- 1 - On
- 2 - Off

b - Fresh air distribution

- 1 - Cab
- 2 - Cargo room or passenger compartment

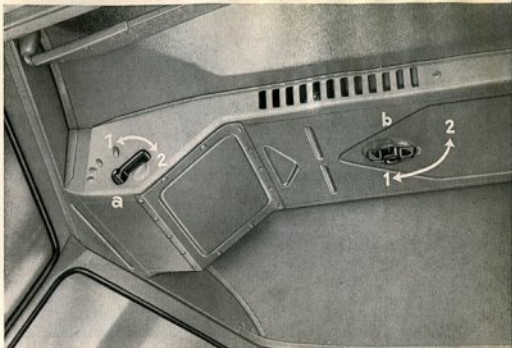

rearmost position, the air intake is fully closed. The distribution of the fresh air is effected by means of deflector plates which are moved by a handle at the bottom of the air guide channel.

With handle in oblique position:

Both cab and cargo room or passenger compartment are ventilated.

## THE SUN ROOF

is free to slide by placing the locking lever to the left. It may be fixed in any desired position by merely moving the lever to the right. It is good practice, however, to open the roof fully prior to sliding it to the desired position. This will not only make the opened roof look better, but will also save the material by a proper folding.



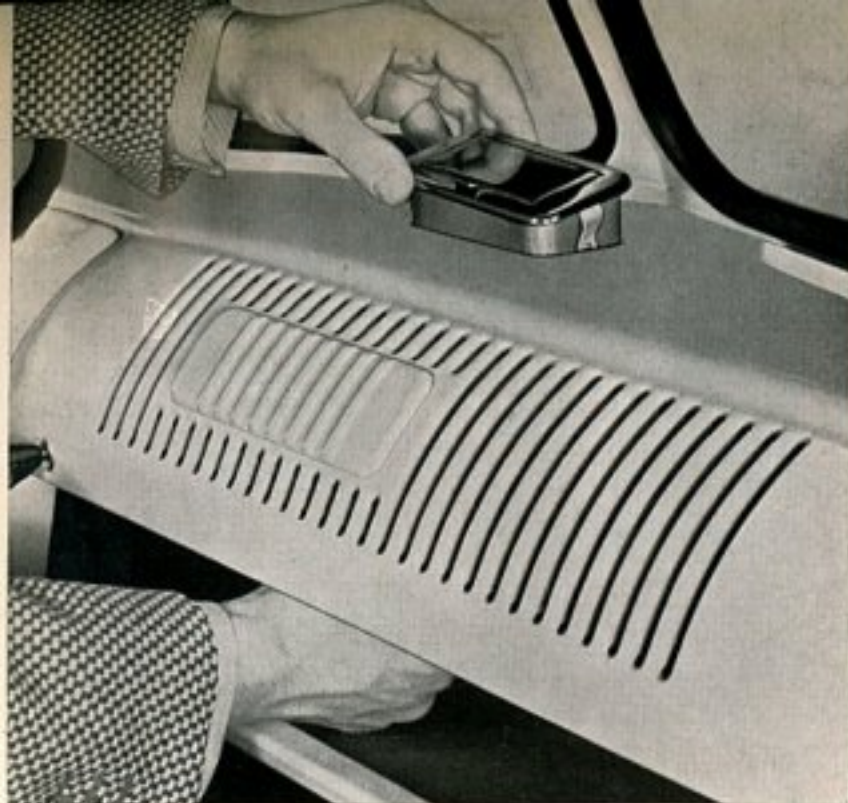

### **THE ASH RECEIVER**

in the instrument panel can be easily removed by pushing it upward from below the panel.

The ash receivers in the passenger compartment of the VW Micro Bus are pulled up for removal.

# PRACTICAL DRIVING

## BREAKING-IN (RUNNING-IN) PERIOD

does not imply inconvenience as your VW Transporter needs no "breaking-in".

Progressive refinements have raised the VW Engine to its present predominant position and it is these refinements which allow an omission of breaking-in instructions. Your vehicle may be operated right from the beginning at the full speeds recommended for the gears.

1 <sup>st</sup> gear	0—10 m. p. h. (0—16 k. p. h.)
2 <sup>nd</sup> gear	6—20 m. p. h. (10—32 k. p. h.)
3 <sup>rd</sup> gear	12—32 m. p. h. (20—52 k. p. h.)
Top gear	20—56 m. p. h. (30—90 k. p. h.)

For easy reference you will find the upper speed limits for the 1<sup>st</sup>, 2<sup>nd</sup> and 3<sup>rd</sup> gears marked in red Roman numerals on the speedometer dial.

## THE LIFE OF YOUR VW TRANSPORTER, ITS PERFORMANCE, AND ITS OPERATION WILL DEPEND ON YOUR DRIVING HABIT

Maximum satisfaction in the running of your vehicle will be assured by following the fundamental rules for driving an automobile:

- Do not unnecessarily race the engine no matter whether the vehicle is stationary or in motion.

The new engine is not governed. Therefore, it is good practice to glance at the speedometer hand from time to time.

- Do not allow the engine to labor by driving at too low speeds.

Don't think that your engine will be saved and preserved most when it is operated at low speeds. You won't reduce the fuel consumption either. The VW Engine requires air for cooling, which it gets when it is running fast enough. It is overloading and overheating that is harmful to the engine, but never high speed operation.



— **When driving up-hill**

always change gear as soon as the speed drops and the speedometer hand approaches the maximum speed limit of the next lower gear. Never allow the engine to labor in 4<sup>th</sup> gear, which is nearly an overdrive, and still expect it to pick up speed on feeding more gas.

**ECONOMICAL OPERATION**

is one of the outstanding features of your vehicle. However, getting a few extra miles from each gallon depends on the manner in which you handle your vehicle and shift the gears.

— **When accelerating,**

step on the accelerator pedal slowly and only to such an extent as is necessary for reaching the desired speed. Depressing the accelerator pedal rapidly does not improve acceleration, but results in an increased fuel consumption.

— **Do not "pump" the gas pedal**

unless circumstances require it. Even the small quantity of fuel additionally discharged by the accelerator pump each time the accelerator pedal is depressed results in a marked increase in the overall fuel consumption.

— **Operate your vehicle smoothly and flexibly**

both when driving in city traffic and on main roads. Adapt the speed of the vehicle to prevailing road and traffic conditions. A good driver accelerates the car gradually, slows down in time, and utilizes the braking power of the engine. Make use of the full acceleration capacity and the excellent brakes of your VW Transporter only when you really need it.

**HOW TO DRIVE AT HIGH SPEED WITHOUT SACRIFICING FUEL ECONOMY**

When you have accelerated the vehicle to the desired speed, slowly let the accelerator pedal return to the position which just maintains this speed. This practice is especially economical when driving on highways. If you attach particular importance not only to the economy of your vehicle, but also to a fair average speed, it would prove of value to make a compromise in the choice of the cruising speed in the interest of fuel economy.

The most economical speed in fourth gear is between 45 and 65 k. m. h. (28 and 40 m. p. h.)

The fuel consumption does not go up equally with the speed; it increases more rapidly at higher speeds. Perhaps you are aware of the fact that air resistance is an obstacle for all high-speed vehicles. Due to the simple and sweeping lines of your VW TRANSPORTER, the air resistance is relatively low, but it should be remembered that high road speed always involves a greater fuel consumption.



## WATCH THE ROAD

closely while driving. As to using the various levers, switches and controls, you now are able to operate them automatically. Furthermore, your TRANSPORTER will "tell" you of its own accord when it needs attention.

## DIRECTION INDICATORS

The direction indicators lie outside the driver's view. However, the red indicator light will serve as a reminder in case you have forgotten to turn the signals off.

The direction indicator switch can be operated without taking the hand off the steering wheel.

## GENERATOR AND COOLING

are controlled simultaneously by a red light. The light will show when the ignition is turned on and when the engine is running at low speed. The light should go out as speed is increased.

**CAUTION!** If the red light goes on while you are driving the vehicle, the fan belt may be broken. Bring your vehicle to a stop and find out what is wrong, for if the belt is broken, the cooling is disrupted and the generator no longer charges.

## OIL PRESSURE

The oil pressure of your vehicle is as important as the oil level. When the ignition is turned on, the green oil pressure light will go on. The light should go out when the engine is started and the oil pressure increases.

**CAUTION!** If the green light goes on with the engine running, the chances are that the oil circulation has been interrupted, which means that the lubrication of the engine has ceased. Stop at once and check the level of the oil before you consult a Service Station. An occasional flashing up of the lamp with the engine warm and at low speed does not indicate trouble if it goes off again as the speed increases.

## HEADLIGHTS

The high beam of your headlights throws glare into the eyes of oncoming drivers. You know yourself how unpleasant and dangerous this is. For this reason, be considerate! The blue light will tell you when the high beam is switched on. Just step on the dimmer switch to transfer the headlights from high to low beam.

## Red Diamond

## Red Light

## Green Light

## Blue Light

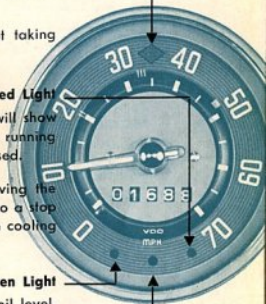

## **SPEED**

The speed of your VW TRANSPORTER is liable to be underrated due to its perfect driving comfort. Special attention should be paid, therefore, to the speedometer during the initial driving period.

## **SAFETY FIRST**

Safety for yourself, and safety for others, this is what counts most! Your VW TRANSPORTER is a vehicle that "hugs" the road in an excellent way, and does not sway when taking a turn. Your vehicle has an extraordinary capacity for acceleration. Yet, the feeling of security and safety which you will acquire after a few miles should not tempt you to become careless.

Therefore, adjust the speed of your Transporter to the conditions of road, traffic and weather, and always be ready to bring it to a stop when it is necessary. Be particularly careful when driving on wet or icy roads, for even a VW TRANSPORTER is apt to skid when not driven carefully under such conditions.

## **THE REAR VIEW MIRROR**

can be adjusted from the driver's seat for the most comfortable observation. Set it in such a manner as to be able to watch the entire width of the road behind the vehicle to a great distance without turning the head or the upper part of the body.

## **PASSING OTHER CARS**

Pass other vehicles with consideration. Always be sure that the road is clear ahead of you, and look out for cars approaching you from the opposite direction. A brief look in your rear view mirror will tell you whether another car is about to pass you from behind. If you have to shift to a lower gear, do it before, not while, passing other cars.

And here is another warning: Never try to pass a car when approaching a curve, where vision is not clear, and never pass a vehicle at the crest of a hill or at crossroads! You never can tell what lies ahead of you!

Be fair and do not step on the accelerator when another car tries to pass you. You will endanger your life and others!

## **STOPPING YOUR TRANSPORTER TEMPORARILY**

When stopping your vehicle in front of a traffic light or railroad crossing, do not wait for free passage with the clutch pedal pressed down and the gear lever in position. Shift to first gear shortly before moving on again, it will preserve the clutch!

## PARKING YOUR TRANSPORTER

in a space between two other cars that are parked at the curb will be fun for you if you heed the following advice:

Stop your vehicle even with the car in front of you. Turn the steering wheel sharply to the right and back your vehicle slowly into the gap.



When the front bumper of your Transporter is even with the rear bumper of the car ahead of you, turn the steering wheel fully to the left, and back up further toward the curb.



Now turn the steering wheel again to the right and pull up a little bit, until both ends of the vehicle come as close to the curb as possible.



When parking on a steep gradient set the hand brake so as to keep the vehicle from rolling. As a precautionary measure, it is advisable to engage first or reverse gear in addition to the hand brake. And do not forget to take the key out of the ignition switch before you leave your vehicle!

Prior to locking the left-hand door secure the right door by lowering the inside door handle.

Do not forget to shut the fuel tap and to lock the door windows when leaving the vehicle stationary for a longer period.

# COLD WEATHER HINTS

## IN WINTER

there are two advantageous features of your VW TRANSPORTER that you will really appreciate:

### AIR COOLING AND HEATING

You may expose your vehicle to bitter cold without fear: — its air-cooled engine will always be ready to start! You will drive in warm comfort, well protected from drafts and from sleet and snow, while a current of warm air will keep your windshield free from condensation and frost, permitting you a clear view.

The increased stress that your vehicle has to stand in winter because of frost and dampness can be easily dealt with if you observe the following:

### THE WARM AIR HEATING

can be regulated by a rotary knob situated at the right-hand side under the seat:

Anti-clockwise — On (1)

Clockwise — Off (2)

The warm air distributor in front of the hand brake lever provides an additional control for foot space and defroster nozzles.

Heating efficiency can be considerably increased by opening a vent wing a little. The heated air can then be inducted easier in the interior of the vehicle which is comparatively tight otherwise.

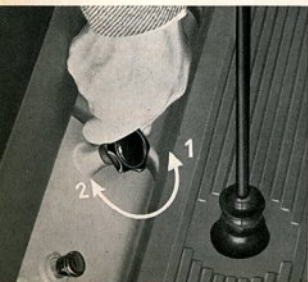

## ENGINE OIL

SAE 20 W/20 oil will not congeal at temperatures above 0°C (+32°F) and will permit easy starting of the engine. If, however, the anticipated atmospheric temperature during the interval in which the oil will remain in the crankcase is below freezing point, it is recommended to use SAE 10 W oil. This grade oil may remain in the engine with safety when the temperature again rises to a higher range. Should it become necessary to add oil in the period between two regular oil changes, SAE 10 W oil may be used at lasting frost and SAE 20 oil when the temperature average rises. This means that the grades SAE 10 W and SAE 20/20 W can be mixed without involving any disadvantages, but be sure to use always the same brand and type of engine oil.

In extremely cold weather, allow the engine to idle for half a minute before driving to insure correct oil circulation.

### **Don't race the engine in severe frost to obtain a quick start.**

Only if your VW Transporter is mainly operated for short distances **during cold weather** is it recommended to have the oil changed at more frequent intervals, say every 2000 km. (1250 miles), using the prescribed HD oil. In the warmer season, oil changes in addition to those laid down in the Lubrication Chart are unnecessary and uneconomical.

In territories where exceptionally low temperatures prevail (arctic climate), it is recommended to use SAE 5 W engine oil, which should be changed every 1000 km. (600 miles). The oil strainer should also be cleaned.

## TRANSMISSION OIL

SAE 90 gear lubricant is recommended for use when the average temperature range will not be lower than 0°C (+32°F). However, where the temperature is expected to remain below freezing point for an extended period of time, SAE 80 grade should be used.

## THE CHASSIS

is particularly exposed to the cold and wet weather in winter. For this reason it will be necessary, and only logical, to adhere strictly to our instructions for lubrication. If, in addition, you spray the bottom of the vehicle with a special chassis oil, as a protection against rusting, you will prolong the life of your VW Transporter.

## **THE BRAKES**

of all automobiles are exposed more or less to splashing water which in winter is apt to freeze in the brake drums. Therefore, when parking your vehicle, do not set the hand brake but shift to first or to reverse gear — for safety's sake! At the beginning of the cold season, the conduit tubes of the brake cables should be thoroughly lubricated with anti-freeze lubrication grease. Do not use just any car-lubricant, but get the right one at any VW Dealer!

## **TIRES**

Worn off tires are apt to cause trouble in winter. To assure a safe operation, replace them in time. To meet the special requirements in winter, so-called **M + S** tires are available. These special-tread tires are designed to give a better grip on mud and snow. They are either used on the rear wheels only or on all four wheels. However, during the rest of the year you should use the usual tires.

## **NON-SKID CHAINS**

You will need non-skid chains only when the roads are covered with snow or ice. Without such chains the rear wheels of your vehicle are apt to spin, and applying the brakes may result in skidding. Have the non-skid chains adjusted to the wheels if you wish to avoid loss of time and inconveniences later on! When driving on long stretches that are free from snow, the chains should be removed to prevent excessive wear of both chains and tires.

## **THE BATTERY**

is under greater strain in winter than in warmer seasons because of the increased consumption of current when starting the engine and using the lights at night. Besides this it is a characteristic feature of any battery that its efficiency decreases at lower temperatures. If the vehicle is mostly operated for short distances, the battery may call for an additional recharging.

Therefore, have your battery checked regularly and you will never have starting difficulties.

## **SPARK PLUGS**

will aid cold starting substantially in extremely cold weather when reducing their gaps to 0.4—0.5 mm. (.016"—.020").

The normal gap is 0.7 mm. (.028").



## LUBRICATION

### **PROPER LUBRICATION IS OF VITAL IMPORTANCE TO YOUR VW TRANSPORTER**

The extra time spent in following these recommendations will be amply rewarded in the long run by your vehicle's efficient performance. It is up to you to maintain the standard of safety offered by your VW TRANSPORTER, and to insure the long life and good service which you have the right to expect from this truly economical vehicle!

### **TO LUBRICATE CORRECTLY MEANS TO LUBRICATE CAREFULLY AND AT PRESCRIBED INTERVALS!**

Therefore, do not shy at the work connected with the regular lubrication service. A Lubrication Chart can be found on page 75, indicating the respective mileages at which to lubricate. Our Service Policy makes it possible for you to have your Volkswagen lubricated at an authorized workshop by skilled hands, at lowest cost and in a minimum of time. You really cannot afford to miss this opportunity.

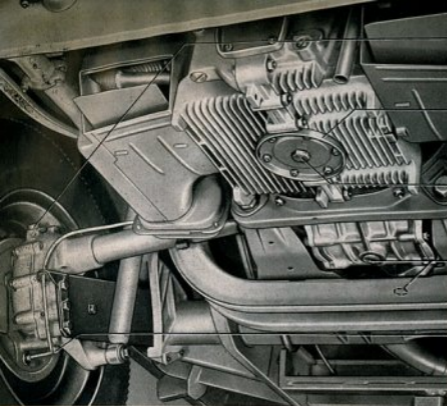

**Oil Filler Plug**

**Oil Strainer**  
with cover

**Oil Drain Plug**  
for crankcase

**Magnetic Oil  
Drain Plugs**  
for rear axle and  
transmission

**Oil Drain Plug**  
for reduction gears  
at rear wheels

## ENGINE OIL CHANGE

Regular oil changes are necessary even if the very best trademark oils are used. Diluted and dirty oil in your engine simply means a greater strain and a shorter period of life for your engine. On the other hand, provided that HD oil is used, it is unnecessary and uneconomical to change the oil more frequently than called for in the Lubrication Chart.

The oil is drained by removing the plug in the oil strainer bottom plate. To insure complete draining, it is important that the operation be performed while the engine is warm. The plug is then screwed in again and tightened by hand.

The engine is refilled with  
**2 1/2 liters of HD oil**  
("For Service MS")  
(5.3 U.S. pints,  
4.4 Imp. pints)

The constant use of HD oil renders a flushing of the engine unnecessary.

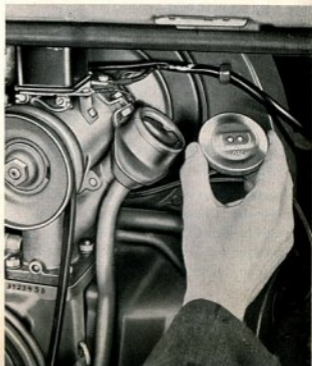



- 1 - Gasket
- 2 - Oil strainer
- 3 - Gasket
- 4 - Bafflem plate
- 5 - Oil drain plug and seal
- 6 - Nut and spring washer

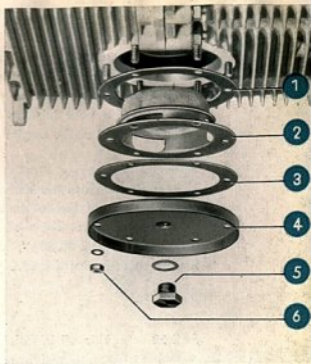

## THE OIL STRAINER

retains foreign matter and should be taken out and cleaned as called for in the Lubrication Chart. The two gaskets should be replaced each time the strainer is removed.

## TYPES OF LUBRICANT AND RECOMMENDED USAGE

The advantages of using a

**trade-mark HD oil ("For Service MS")**

are quite evident.

HD oils have proved oxidation stability, bearing corrosion preventive properties and detergent-dispersant characteristics which tend to hold in suspension foreign contaminants which would normally settle on engine parts. These foreign contaminants will drain out with the oil at the periodical oil changes. The detergent properties of HD oil will make the fresh oil darker after a short time of operation. This is quite natural and there is no reason whatsoever to change the oil earlier than called for in the Lubrication Chart.

**Additional lubricating agents** should not be added to HD oil.

## SOME MORE INFORMATION ON ENGINE OILS

It is left to your discretion to select an oil from well-known and dependable brands of the proper viscosity to suit your seasonal and driving requirements. In cases of doubt, refer to your authorized VW Dealer who will be glad to help you with your lubrication problems. It is recommended that you select "your" oil right at the beginning and stick to it at all future service oil changes.

The requirements of the VW engine are met by all approved commercial brand oils. Viscosity of the lubricant is an indication of its resistance to flow at a given temperature. The SAE numbers classify lubricants in terms of viscosity, for example: SAE 20/20 W, SAE 10 W etc. Ambient air temperature is decisive for the selection of the SAE group to be used.

**SAE 30** This oil is satisfactory in tropical climates where the temperature range will frequently rise above 30° C (86° F).

**SAE 20 W/20** engine oil is recommended for use within the temperature range from +30° C to 0° C (+86° F to +32° F). It may also be used with safety should temperatures temporarily exceed these limits.

**SAE 10 W** engine oil is recommended for use if the temperature is anticipated to fall below 0° C (+32° F). It may also be used with safety should temperatures rise above freezing point. A change of oil is, therefore, not necessary until the next regular mileage interval.

**SAE 5 W** This oil is for use in arctic climate (below -25° C) only (in place of SAE 10 W).

In some countries API Classification is applied (API = American Petroleum Institute). According to this classification, the oils suitable for the VW Engine are referred to as "For Service MS". For further details see page 27.

## IGNITION DISTRIBUTOR

The amount of grease at the breaker arm fiber block should be checked and, if necessary, replenished at the specified intervals.

Every 12 000 km. (7200 miles), apply 2 or 3 drops of oil to the felt in the cam bearing after the rotor is taken off.

## TRANSMISSION AND DIFFERENTIAL

The transmission gears and the differential of your VW Transporter are combined in the transmission case and are both lubricated with the same transmission oil. This kind of oil can be readily distinguished from engine oil by its heavier viscosity and darker coloring. An early change of oil, while the gears are being broken in, will contribute to a smoother operation of the transmission. The used oil should be drained by simultaneously removing the two socket-head magnetic drain plugs 17 mm, while the oil is still warm.

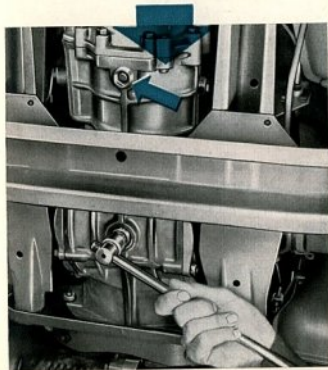

Then refill with **2 liters of transmission oil (4.2 U.S. pints, 3.5 Imp. pints).**

The magnetic oil drain plugs should be thoroughly cleaned at speedometer readings of 300, 1200 and 2400 miles. After that every 2400 miles.

This does not imply draining the oil. A spare drain plug or a wooden plug should be used to close one of the two drain holes in turn. Then check oil level (to be kept somewhat below the edge of the filler hole).

In order to maintain the characteristics of the transmission oil, it should not be mixed with any other oil.



### REAR WHEEL REDUCTION GEAR

Each rear wheel reduction gear case should be refilled with  
**0.25 liters of transmission oil (0.53 U.S. pint, 0.44 Imp. pint)**  
at the same intervals as the transmission case.

### STEERING GEAR

The steering assembly should be lubricated with transmission oil SAE 90 exclusively, and under no circumstances with grease or any other oil. The level of the oil in the steering case should be kept at the lower edge of the filler plug hole.

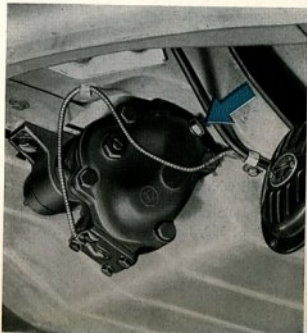

## CHASSIS

A thorough lubrication of the front axle bearing points can be carried out properly only by raising the front axle so that the weight is taken off the wheels.

Prior to lubrication, the grease fittings should be cleaned thoroughly with a clean piece of cloth, so as to avoid any dirt or foreign matter from entering the

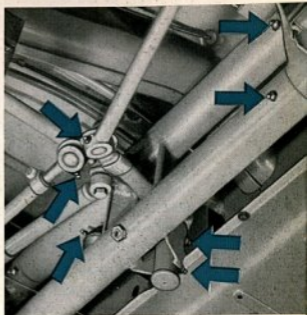
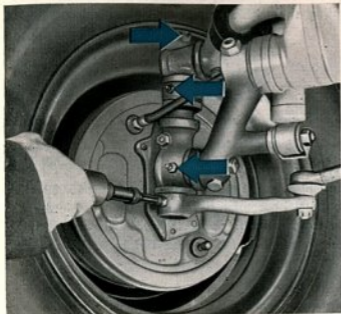

fittings. The tip of the grease gun should be pressed onto the fitting, whereupon grease should be injected until the excess grease begins to emerge at the edges of the lubrication point.

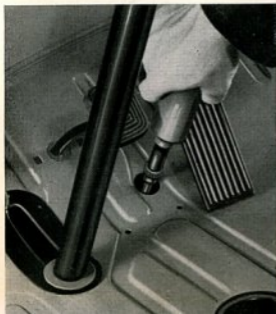

The number and the location of the lubrication points of the chassis can be gathered from the Lubrication Chart and the corresponding illustration.

Tires and brake hoses should not come in contact with either grease or oil. Even smaller quantities must be wiped off straightaway.

**If the vehicle is driven mainly over rough roads, it is recommended to lubricate king pins and outer tie rod ends at more frequent intervals, say every 1000 km. (600 miles).**

Annually, at the beginning of the cold season, the cables and conduit tubes of clutch, accelerator and heating should be cleaned and greased.

## THE FRONT WHEEL BEARINGS

If required, apply some grease to the ball-shaped surface of the clutch cable adjusting nut at the clutch operating lever located on the transmission case.

According to the lubrication chart the front wheel bearings are to be cleaned and repacked with grease as specified in the lubrication chart every 15 000 miles (24 000 km.). The brake drums must be removed for this purpose. Finally the front wheel bearings must be adjusted. In order to avoid damage to the bearings this operation should, if possible, be carried out by a VW Dealer.



## BRAKE CABLES

Inject some grease into the fittings of the conduits in order to maintain easy operation of the brake cables.

## GEAR LEVER

The gear lever can, if necessary, be lubricated when removed. To do this, remove the two screws that attach the lever dome to the floor plate and lift off lever, dome and spring as a unit.

The contact surfaces in lever dome, at stop plate and lever ball socket should

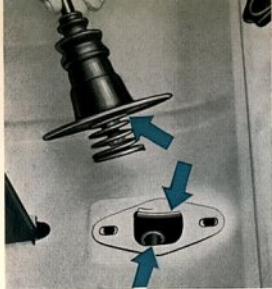

be amply provided with universal grease. When installing the stop plate, make sure that the turned-up edge is on the righthand side.

After installation, make sure that the gears engage properly.

## DOORS AND LOCKS

The striker plate contact surfaces should be slightly greased. Apply a few drops of oil to the lid hinges. Door hinges are to be well oiled at least at every service lubrication or, better yet, once every week after dust and dirt have been cleaned off the lubrication points.

Door cylinder locks should be treated with graphite. Blow a small quantity of powdered graphite through the key hole. Dip the key into the graphite, insert key and move it back and forth several times.

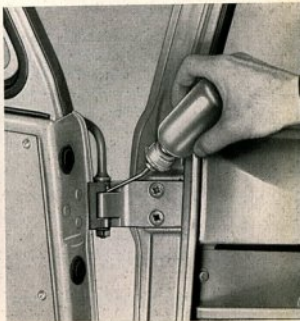



## WHEELS AND TIRES

The importance of proper tire pressure has already been explained on page 13. Here are a few hints.

Bad driving habits also lead to premature tire wear. High speed driving and cornering, skidding to a stop and striking curbs or objects on the road wear tires more than many miles of careful driving.

Tire life is also considerably shortened by incorrect front wheel alignment or lack of balance of the tire and wheel assemblies. The tire tread should never be allowed to wear down to a thickness of less than 1 mm. (.04") which is the absolute minimum required for a safe operation.

A drop of oil applied to the wheel mounting bolts will facilitate the next tire change.

Avoid overloading the vehicle and protect the tires from intense sunlight, fuel, or oil. Normal wear may be kept at a minimum by interchanging wheels and tires including the spare at approximately 4000 km. (2500 miles) intervals. Take the opportunity to check the tires for penetration of foreign matter and other damage. Rotate wheels as indicated below.

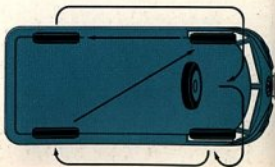



The spare wheel is accommodated behind the driver's seat back. It is accessible by removing the back.

To obtain a smooth high speed operation and a long life, it is important to have the wheels balanced statically and dynamically when tubes and tires have been repaired. As, due to normal wear, a relocation of the unbalance is possible after a prolonged period of operation, the wheels should be balanced every 7200 miles (12 000 km.).



When the tires are being mounted, the red mark on the sidewall should be lined up with the valve to insure better balancing of tube and tire.

## CHANGING WHEELS

Changing a tire on the road certainly is not pleasant. However, it will be easier after you have read these few lines which tell you the correct way. Underneath the cab seat you will find the jack and tool kit required for changing tires.

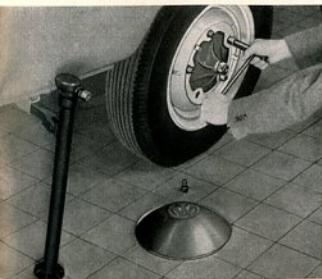

- 1 - Set the handbrake securely and block the wheel opposite the one to be removed to prevent the vehicle from shifting off the jack.
- 2 - Insert jack into the square tube below the body.
- 3 - Remove hub cap by means of hub cap removal tool.
- 4 - Loosen wheel bolts by means of the socket wrench before wheel is fully jacked up.
- 5 - Raise jack until tire clears ground.



- 6 - Remove wheel bolts and take off wheel.
- 7 - When reinstalling the wheel, operate the jack until the five holes in the wheel are nearly lined up with the holes in the brake drum.
- 8 - First, insert one wheel bolt only. Tighten it to such a degree as to allow the wheel to be swung around this point by hand, until the remaining holes in the wheel and brake drum coincide.
- 9 - Insert and tighten the remaining bolts until the countersunk heads of the five bolts are centered in the corresponding recesses of the wheel.
- 10 - Tighten all bolts diametrically opposite in turn.
- 11 - Lower the vehicle sufficiently for the tire to reach the ground and make sure that all bolts are tight.
- 12 - Install hub cap with a heavy stroke and make sure that it is tightly seated.



## CARE OF THE VW TRANSPORTER

### CLEAN AND NEAT APPEARANCE

To keep the VW TRANSPORTER looking smart and new is a matter of pride to the driver or owner of the vehicle. Regular and efficient care will protect not only the outer appearance of the vehicle but also the body and the chassis.

### WASHING YOUR VEHICLE

Wash your new VW Transporter frequently during the first weeks. This practice will be of great advantage to the finish. For washing you require a soft sponge for the body, a soft brush for the wheels, a sturdy, long-handled brush for the chassis and plenty of clear water! For drying you need a chamois.

The chassis and lower part of the body should first be flushed with water, to soak off the dirt, and afterward a brush should be used.

Apply an even spray of water on the exterior finish of body and wheels until dirt is soaked off. Do not allow a hard jet of water to hit the varnished surface. Using plenty of clear water, dirt should be removed with a sponge. Care should be taken to clean the sponge at short intervals so as to avoid scratches on polished parts. There are some approved auto soaps and detergents which greatly facilitate this job. Avoid the use of any product which has not been recommended by your VW Dealer. It is of utmost importance to wash the body thoroughly with water after the car-wash has been applied to insure that no traces of it remain on the body.

After washing, rub down with a clean chamois to prevent water spots.

## **PRESERVATION (WAXING)**

means to restore to the finish certain substances it has lost by exposure to the weather. As these substances are vitally important to the elasticity of the finish, it is necessary to apply a protective water-repellent coat of wax to the body. The intensive cleaning effect of the shampoo removes this protective coating so that it should be renewed accordingly.

A preservative specially produced for the finish of your VW TRANSPORTER can be obtained under the designation "L 190" from your VW Dealer. The body should be waxed after the first eight or ten weeks and then regularly at intervals of from six to eight weeks — in any case after each soap or detergent washing, as already mentioned. Applying the preservative is quite easy: With a soft cloth, spread a thin film on the finish, then rub it down when dry (after about 20 minutes), using polishing cotton or a soft polishing cloth, until iridescent colors can no longer be seen when standing at an angle to the polished area. Of course, the vehicle must be washed and dried carefully prior to applying the preservative.

## **POLISHING**

You should polish your VW Transporter only if its appearance has been strongly affected by road dust, sunlight and rain in consequence of insufficient care and if the application of the preservative no longer restores the original lustre. Avoid the use of abrasives or chemically harmful products, even if their first application seems to give satisfactory results. A special polish for treating the synthetic-resin finish is also obtainable from your VW Dealer under the designation "L 170". Prior to applying the polish, the car must be washed and dried carefully. Dust or soil should never be wiped off dry. The polish should be applied with a soft and clean cloth or polishing cotton — use a straight horizontal or vertical motion rather than a circular motion. After some time of rubbing you will feel a slight resistance, which indicates that the ingredients of the polish have settled in the finish and that the solvent has evaporated. Now take clean polishing cotton and rub the body down until the high gloss is restored.

Do not apply the polish on too large an area of the body at a time.

A subsequent application of the preservative gives you care-free pride in your car for a long time.

**Never wash, wax or polish the vehicle in sunlight.**

## **HOW TO REMOVE SPOTS**

By a mere washing you cannot always remove splashes of tar, oil traces, "baked on" insects, etc. As a matter of principle, such foreign matter should be removed as soon as possible, for if you neglect this rule, permanent damage to the finish may be the result.

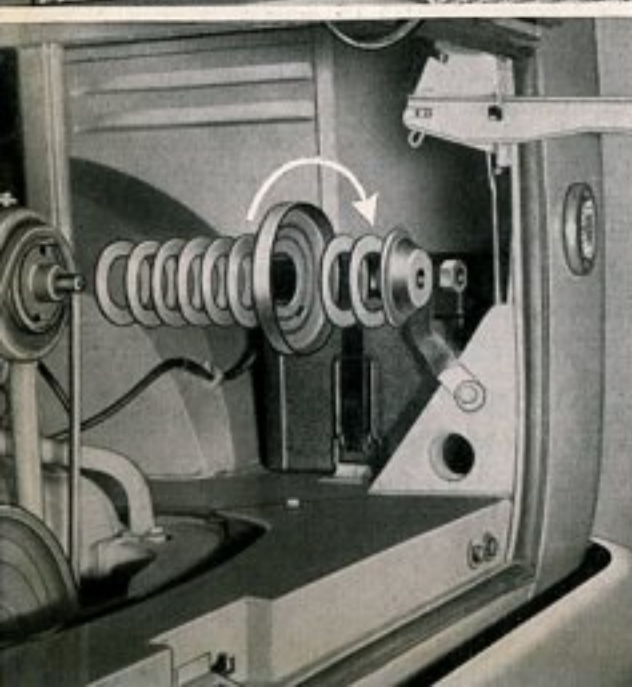
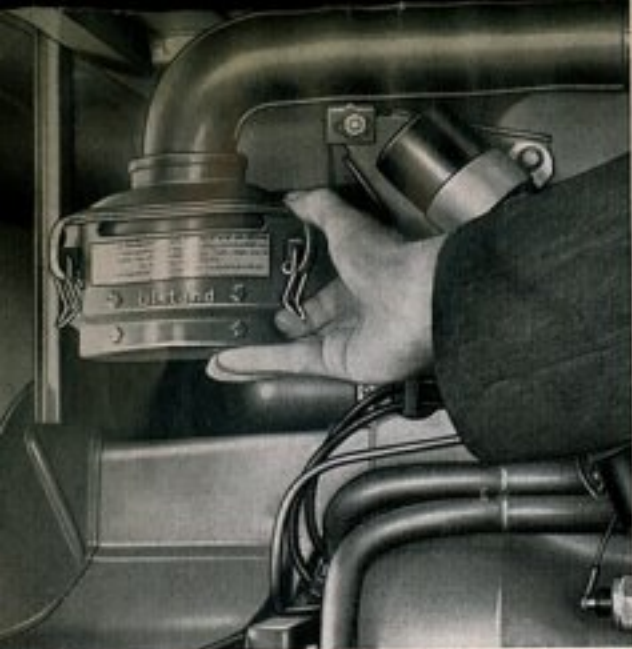

The filter element should be detached from the intake elbow and rinsed in fuel, kerosene, or any other degreasing solution and then dried.

The oil level should be checked and topped up approx. every 2000 km. (1200 miles) in conjunction with the engine oil changes. The oil level should not be above the mark.

If the vehicle is mainly operating in heavily dust-laden atmospheres, it is up to you to prevent premature wear by servicing the air cleaner more frequently than specified above. The air cleaner must, in any event, always be cleaned if there is no thin oil above the sludge at the bottom of the oil reservoir.

#### **ADJUSTING OR REPLACING THE FAN BELT**

To adjust or replace the fan belt, remove nut and outer half of generator pulley. When loosening or tightening nut, insert a screwdriver in the slot cut into the inner half of the pulley, and support it against upper generator housing bolt. The adjustment of the fan belt tension is effected by means of spacer washers situated between the two pulley halves. Belt slackness is taken up by removing one or more washers. If the belt is too taut, one or more washers should be added.

The fan belt should not be too slack, nor should it be too tight. Newly installed belts will stretch to some extent and should, therefore, be checked and adjusted after 50 or 100 kilometers (30 or 60 miles).

**Good Advice:** Buy yourself a new fan belt without delay.

**TAR SPOTS.** An unpleasant sight, to be noticed particularly on light-colored vehicles, are tiny tar spots which show up on hot days when driving on newly tarred roads. Tar splashes have a tendency to corrode the finish within a short time and should be removed immediately when discovered. On the road, you usually will have nothing at your disposal but fuel, which may be applied with a soft cloth. Kerosene or turpentine oil may also be used. After this, the treated spots should be washed with a mild, lukewarm soap solution and rinsed, in order to remove traces of the cleansing agent. It is, however, better to use our preservative already mentioned, which renders the treatment with soap solution unnecessary.

**INSECTS** are caught especially during the night, in hot weather, by the front end of the vehicle. Once baked on they can hardly be removed with water and sponge, but should be treated with lukewarm soap solution.

**BLOOMING TREES** but more especially lime trees in many instances drop tiny quantities of liquid. Cars that have been parked underneath such trees become "freckled" all over. These stains, too, can be readily taken off with soap solution if the necessary steps are taken in time. A treatment of the cleaned spots with the preservative is strongly recommended.

**CLEANING SUN ROOF.** The plastic cover of the sun roof requires no special care. It is cleaned with lukewarm water and mild (not caustic) neutral soap suds and then thoroughly rinsed with clear water. Never use cleaners of alcoholic or chemical content as they have a deteriorating effect on the plastic.

Stains should be removed with a cloth dampened with benzine. All traces of the cleaner should then be washed off with neutral soap suds and the surface finally rinsed with clear water. Be sure the cover is thoroughly dry before opening the sun roof.

A wet top must only dry in the closed position to avoid damp-stains. Especially in a closed garage it is advisable to open the door windows to produce better airing conditions.

**CHROMIUM-PLATED PARTS** should be lightly coated with chromium wax. It is not recommended to use grease or vaseline, as these will bind dust and dirt.

**CARE OF THE UPHOLSTERY.** It is recommended to clean the artificial leather upholstery with a soft cloth or a soft brush. Special care should be taken to remove dust and dirt also from the upholstery seams. A better cleaning effect

is obtained by the use of soft whisk broom and suds of lukewarm water (rain water, boiled or soft water) and any mild soap (castile or olive oil base soaps). Use the water sparingly, as the upholstery otherwise requires a long time to dry, if water trickles through the seam stitches. Grease and paint spots should be wiped off before they dry up. Soaked-in spots can be removed by carefully using a rag moistened with gasoline or alcohol. Spots caused by shoe polish can be removed by means of turpentine. Use these agents carefully and sparingly as otherwise, they would tend to dissolve the dust-rejecting finish of the artificial leather. Solvents such as trichloroethylene or thinner should not be used for cleaning. After completing the cleaning operation, use a clean, soft cloth to polish the surface of the leather. Carefully treat the upholstery seams. Never use furniture polishes, oils, varnishes or cleaners on imitation leather upholsteries. They will injure the finish.

**CLEANING GLASS.** Windows can be cleaned by washing with warm water and wiping dry with a clean, soft linen cloth. In order to facilitate this task on the windshield, the arms of the windshield wipers may be tilted forward. To clean unusually dirty windows, use alcohol or household ammonia and lukewarm water.

## CHECK THERMOSTAT-CONTROLLED COOLING AIR INTAKE

A wrong adjustment of the air cooling throttle ring is responsible for the engine attaining its operating temperature either too fast or too slowly. If the throttle ring opens too far, it may foul the fan resulting in a considerable noise.

The thermostat-controlled cooling air intake is correctly adjusted if

- 1 - the throttle ring rests slightly pre-loaded against the air intake flange when the engine is cold.
- 2 - with the engine warm, the distance from the top edge of the air intake flange to the edge of the throttle ring measures 25—30 mm. (1 to 1.2 in.) when the upper end of the thermostat in the right lower heater channel touches the stop of the support.

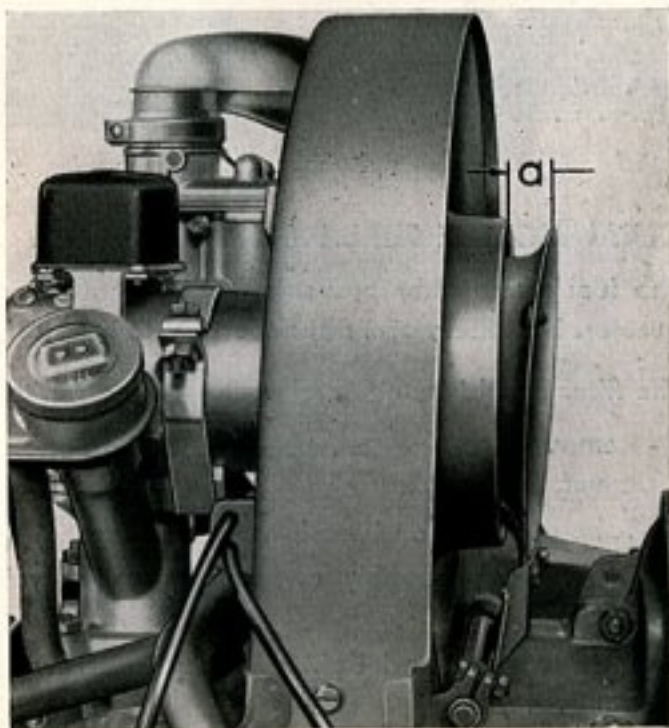

## CHECK ADJUSTMENT

- 1 - Warm up the engine until the upper end of the thermostat touches the stop of the support.
- 2 - Unhook throttle ring return spring.
- 3 - Loosen throttle ring operating lever.
- 4 - Adjust throttle ring so that it opens 25 mm (1").
- 5 - Tighten operating lever and insert return spring.
- 6 - Check thermostat-controlled cooling air intake for proper functioning.





## MAINTENANCE

The VOLKSWAGEN SERVICE ORGANIZATION has made available for you an extensive network of Authorized VW Dealers, staffed with well trained and experienced men, and equipped with all the required special tools and appliances to service your vehicle. If ever you should need service when touring, or away from home, look for the well-known VW Service Sign. The workshop displaying this sign is your assurance of the same expert, prompt, and courteous service you are accustomed to receive at home.

In case you can't get to an Authorized VW Dealer in time, we are giving you some information which, if needed, will help you to carry out normal maintenance work. However, repair jobs which are beyond your capacity should be performed by the nearest VW Dealer. There your VW Transporter will be given expert treatment by those familiar with its construction.

This will save you time, inconvenience and money.

### SERVICING THE AIR CLEANER

All air used for combustion must pass through the air cleaner. Thus the air is freed from dust and grit which might otherwise reach the engine cylinders. Regular attention should be given to the maintenance. A dirty air cleaner reduces the performance of the engine and increases fuel consumption.

The **Oil Bath Air Cleaner** should be cleaned every 4000 km. (2500 miles). Loosen the retainer clamps and detach lower portion from the intake elbow. Remove dirty oil from oil reservoir and refill with engine oil SAE 20 up to the mark.

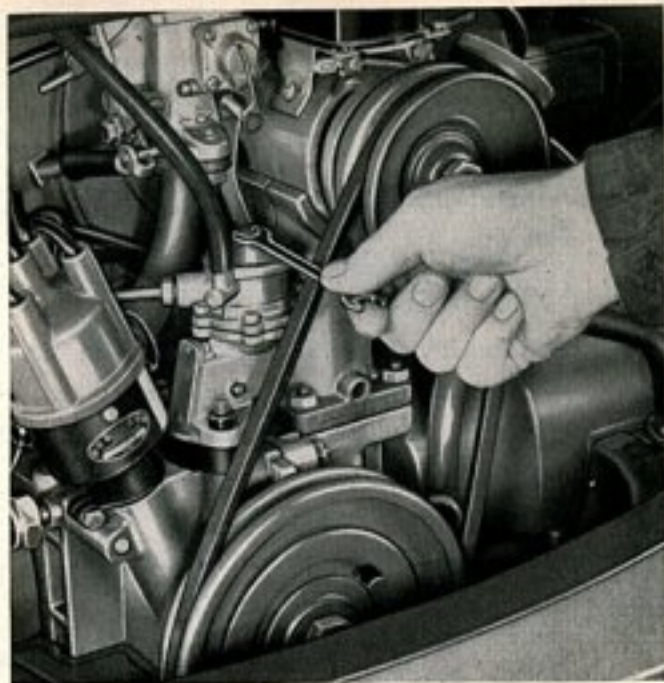

### **CLEANING THE FUEL FILTER**

The fuel pump filter prevents foreign matter and dirt from entering the carburetor. It is, therefore, not necessary to regularly clean the carburetor.

The filter should be cleaned at the prescribed intervals.

- 1 - Remove retaining screw by means of an open end wrench 8 mm and take off cover.
- 2 - Take out filter and wash out in benzine.
- 3 - Dry filter thoroughly and install it. The reinforcement ribs should be at the top.
- 4 - Install cover, and tighten retaining screw making sure the gasket is not omitted.

### **CARBURETOR ADJUSTMENT**

The carburetor is tested at the factory and properly adjusted to the engine. Do not alter this adjustment by exchanging the jets or the venturi for other than the prescribed sizes. This would be detrimental under normal operating conditions, and may result in hard starting, excessive fuel consumption or unsatisfactory engine performance.

Only the idling of the engine may call for a readjustment occasionally. Before attempting to adjust the carburetor, make sure the engine is at normal operating temperature.

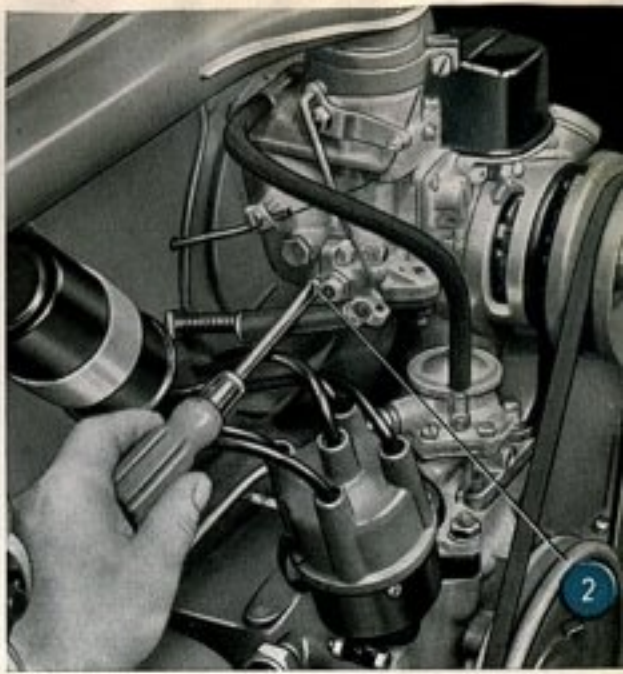
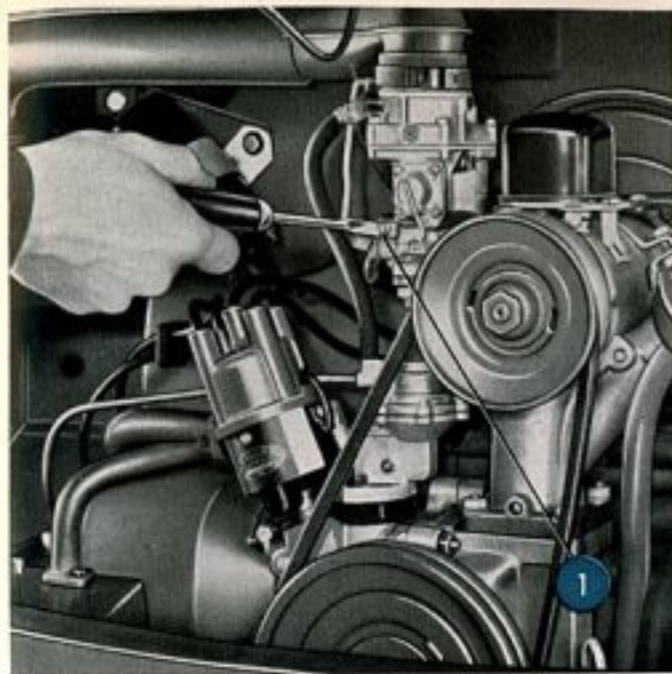

- 1 - Turn the idling adjusting screw (1) in or out until normal idling speed is attained (about 550 RPM).
- 2 - Gradually turn the volume control screw (2) to the right until the idling speed drops, then back it off by  $\frac{1}{4}$  turn. Correct as necessary until the engine idles smoothly.
- 3 - Finally re-adjust the idling speed.

The adjustment is perfect if the engine does not stall after the throttle is suddenly opened or suddenly shut. Poor idling may also be the result of damaged gaskets, intake manifold flanges not sufficiently tightened, faulty ignition or leaky valves.

Skill and experience are required to check and adjust the carburetor. For this reason you should leave this job to an Authorized VW Dealer.

## VALVE ADJUSTMENT

The following procedure should be carried out only in emergencies when it is impossible for you to reach a VW Dealer.



Remove valve rocker cover.

Valve clearance should be 0.10 mm. (.004") with the engine cold. The valve clearance increases when the engine warms up.

For this reason, **only adjust valve clearance when the engine is cold.**

The arrangement of the cylinders may be seen from the numbers 1 to 4 marked on the end plates.

Valve adjustment may be made in the following sequence: 1<sup>st</sup> — 2<sup>nd</sup> — 3<sup>rd</sup> — 4<sup>th</sup> cylinder. Adjust the valves when the piston of the corresponding cylinder is in top dead center position of the compression stroke as both valves are then closed.

Starting with the 1<sup>st</sup> cylinder, crank the engine over slowly *anti-clockwise* by the fan pulley, until both valves are in fully closed position and the timing mark on the pulley is in line with the vertical jointing faces of the crankcase.

Check the valve clearance with a feeler gauge, inserting the gauge between the adjusting screw of the rocker arm and end of the valve. If the clearance requires adjustment, loosen the lock nut of the adjusting screw and turn the adjusting screw as required to obtain the proper clearance. Tighten the lock nut and recheck the clearance. Readjust if necessary.

Check and adjust the other valves to the proper clearance in this manner by turning the crankshaft *anti-clockwise* another 180° for each cylinder.



$a = 0.7 \text{ mm}$   
 $.028''$

## CHECKING THE SPARK PLUGS

Take the spark plugs out and check their exterior. The appearance of electrodes and insulators provides sufficient information on setting and condition of the engine.

### Electrodes and insulator

medium grey — good adjustment of carburetor and correct performance of spark plug,

black — mixture too rich,

light grey — mixture too lean,

oiled up — failure of spark plug or ring blow-by.

Clean the spark plugs with a brush and a chip of wood and blow them out. The insulator should be clean and dry on the outside in order to avoid short circuits or creeping current. Check the electrode gap (0.7 mm. = .028'') and reset if necessary by bending the outer electrode. Look for a proper gasket before installing the plug. Generally speaking you may count on a service life of the spark plugs of up to 15 000 km. (9300 miles).



## CHECK COMPRESSION

After warming up the engine, remove all 4 spark plugs. Operate the starting motor with the accelerator pedal fully depressed and the throttle in a wide-open position. The compression is checked by means of an accredited compression gauge inserted into the spark plug hole of each cylinder.

Result: good	7.0—8.5 kg./sq. cm. (100—120 lbs./sq. in.)
sufficient	4.5—7.0 kg./sq. cm. (65—100 lbs./sq. in.)
insufficient	below 4.5 kg./sq. cm. (65 lbs./sq. in.)

## IGNITION AND TIMING

Particular attention should be attached to the importance of correct ignition timing. The operation of the engine will be seriously affected if the ignition breaker points are not properly timed and correctly spaced. In many cases poor performance, high fuel consumption and even severe damage to the engine can be the result of an incorrect ignition setting. That is why no attempt should be made to alter the ignition timing, no matter whether super premium fuels are used or not.

Adjust the ignition with the engine cold.



## ADJUSTING CONTACT POINTS

Remove distributor cap and rotor. The breaker contact points are adjusted by cranking the engine until the fiber block on the contact arm rests on the highest point of the cam lobe. Then loosen the stationary point locking screw and turn the eccentric adjusting screw until the correct gap is obtained. Use a feeler gauge of the proper thickness (0.4 mm. = .016"). Tighten lock screw and recheck the gap.

If the points are burned, rough or pitted, clean them with a contact file or, better yet, replace them. The distributor cap should be clean and dry, inside and out, so as to avoid short circuits and creeping current.

**AFTER THE CONTACT POINTS HAVE BEEN ADJUSTED, IT IS ABSOLUTELY NECESSARY TO CHECK THE IGNITION TIMING WITH THE ENGINE COLD.**

### **IGNITION TIMING**

Crank the engine until the mark of the crankshaft pulley lines up with the vertical crankcase jointing faces and the distributor rotor arm is in the position

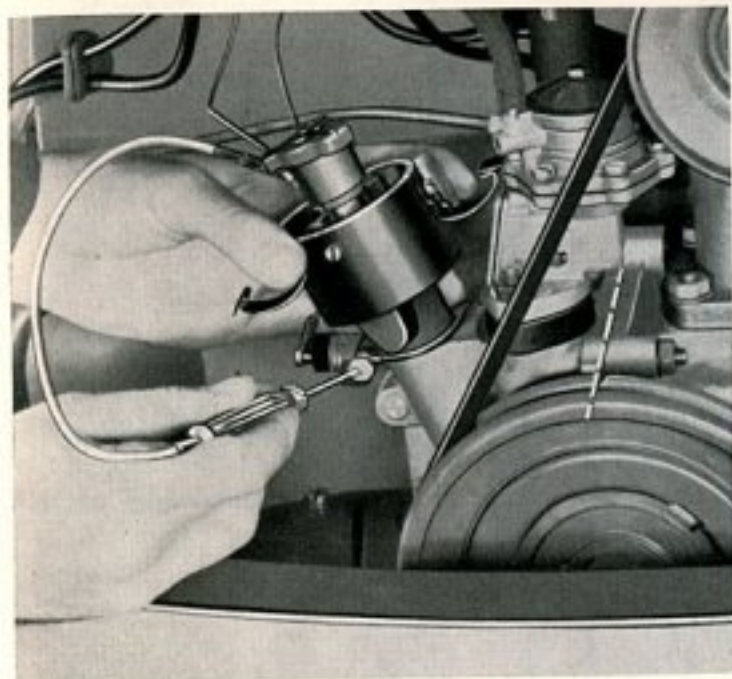

for firing on the No. 1 cylinder (see mark on rim of distributor base). Loosen the lock screw below the distributor base and rotate the distributor body clockwise until the contact points are closed. Now switch on the ignition and rotate the distributor slowly anti-clockwise until the contact points just start to open. This may be seen and heard, for a spark will jump from one point to the other.

To obtain a more accurate adjustment for maximum results, it is advisable to use a test lamp (6 volts) or an ignition timing light. The test lamp should be connected to the distributor primary lead terminal and to the ground. The lamp will light up as long as the contact points are kept open by one of the four cam lobes of the distributor shaft.

After the adjustment is completed, tighten the lock screw, replace the rotor and clamp the cap on the distributor. Check the ignition timing again.

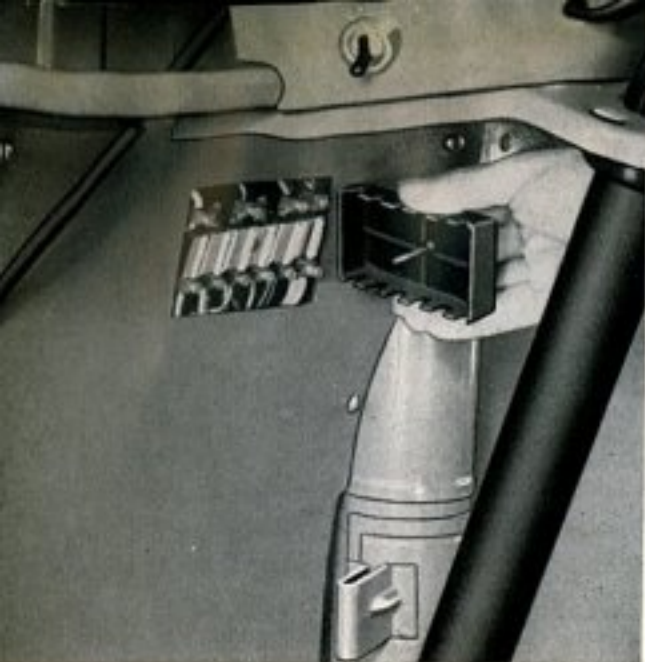

## EXCHANGING FUSES

The fuse box is located below the parcel shelf. When a fuse has blown out, it is not sufficient merely to replace it by a new one. Inspect the electrical system for evidence of short circuits or other faults that may have caused the fuse to blow out. Under no circumstances should you use a fuse patched up with tin-foil or wire, because this may result in severe damage. We suggest that you carry with you a set of spare fuses (8 amp.).

## STOP AND TAIL LIGHT BULB REPLACEMENT

The replacement of the bulb for the license plate light is carried out by opening the engine compartment lid and pulling out the socket. The combined right and left-hand stop and tail lights are accessible by removing the rim and taking the lenses out of the rubber seal. Be sure the bulbs make perfect contact in their sockets.





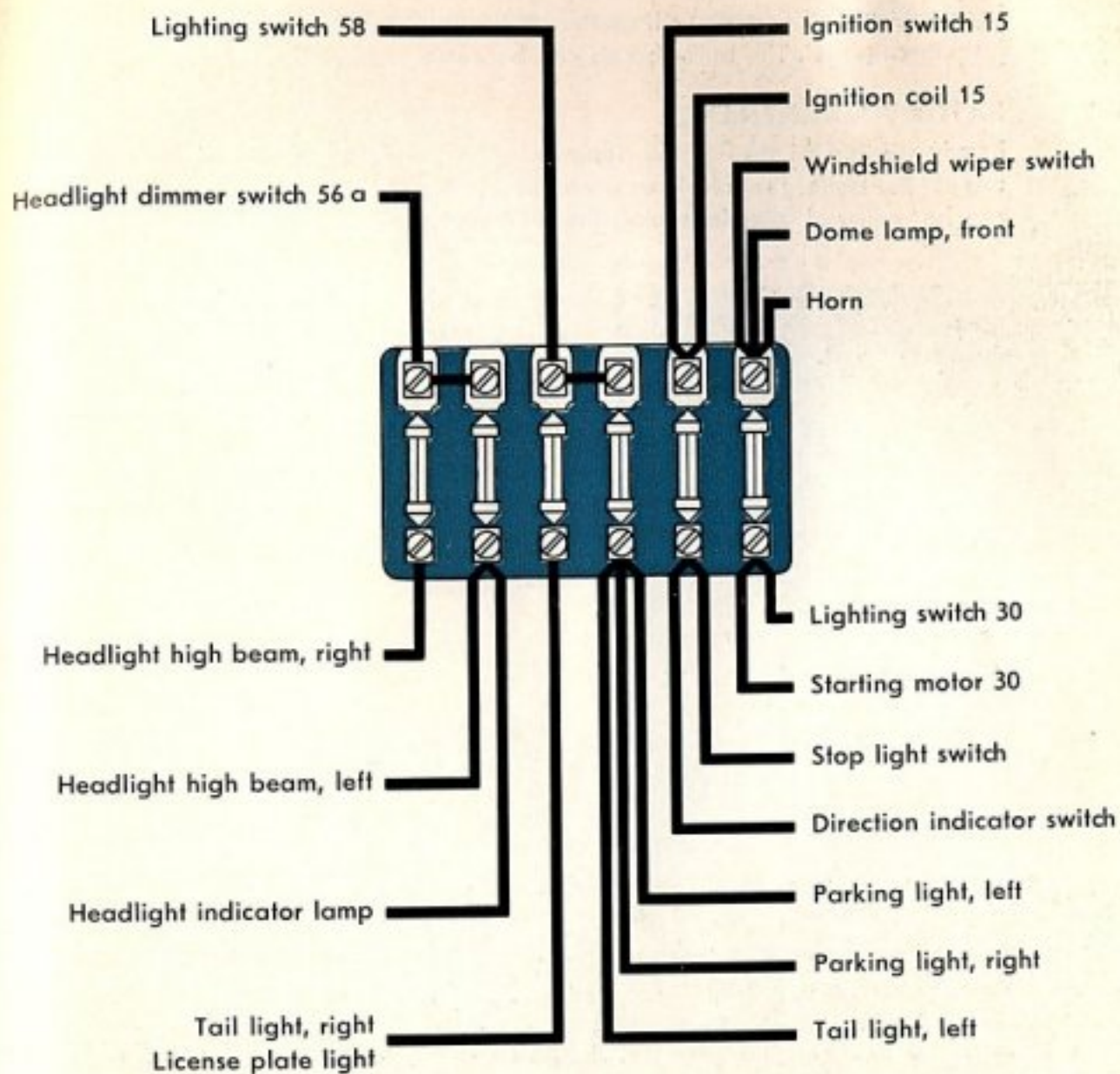

**Fuse box below the instrument panel tray**

### Warning and Instrument Light Bulb Replacement

The warning lights for oil pressure, generator charging, direction indicators, headlight main beam as well as the instrument lighting are situated under the instrument panel. The bulb sockets can be easily removed.

### BATTERY MAINTENANCE

Ready starting of the engine depends upon perfect condition of the battery. Inspect the battery regularly as prescribed in the Maintenance Chart. The cover can be removed after loosening the lever lock.

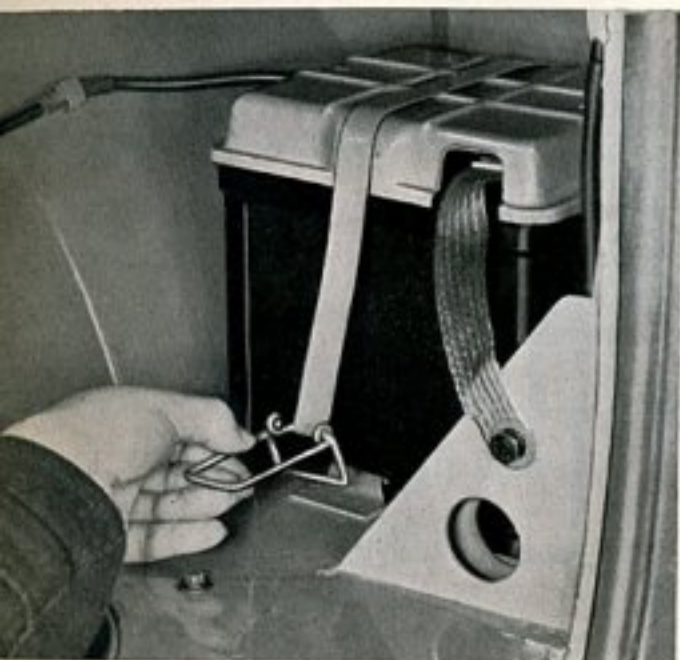

The state of charge of the battery may be checked by means of a battery hydrometer. The specific gravity of the battery liquid will increase with the charging of the battery. Tested with the hydrometer, the density or the gravity can be read from the scale of a float.

Battery fully charged .....	1.285 = 32° Bé
Battery semi-charged .....	1.230 = 27° Bé
Battery fully discharged .....	1.142 = 18° Bé

In addition, a volt-ammeter test should be made to insure that the battery is in good operating condition and able to provide the necessary current. The voltage of each cell should not fall below 1.6 volts while taking the reading (10—15 seconds). Otherwise the cell is discharged or defective. Under no-load conditions each charged cell should read 2 volts.

Add distilled water to each cell to bring the level to approximately 5 mm (.2") above the plates including separators. If there is an acid level mark, make sure that the level coincides with the mark. Losses by evaporation should only be replenished by adding distilled water. Never add acid, unless it is known that acid has been spilled from the battery. Check specific gravity afterwards and compensate if necessary.

Use a stiff brush to remove corrosion from both posts and terminals. Coat the clean posts and terminals with light grease or vaseline to prevent corrosion. Then tighten securely and make sure that there is a proper connection to the ground.

## AIMING THE HEADLIGHTS

If no headlight aiming device is available, proceed as follows:

- 1 - Place the unloaded vehicle in a level position with a dark-colored vertical screen 5 m. (16.4 ft.) ahead.
- 2 - Next draw two cross lines on the screen according to the sketch.
- 3 - The longitudinal center line (vehicle axis) must hit the center of the screen exactly between the two cross marks.
- 4 - Switch on the high (country) beams and check the beams at the cross marks.
- 5 - Independent adjustment of both horizontal and vertical aim is provided with the adjustment screws accessible from the front of the headlight rim.



Dimensions:  $a = 5$  m. (16.4 ft.),  $b = 1100$  mm. (43.3 in.),  $c =$  Distance from floor to center point of headlamp lens,  $d = 50$  mm. (2 in.),  $d$  is the correct distance between the upper limit of the light spot and the center of the cross when adjusting the low (traffic) beam.



Left or right headlight seen in driving direction.

### **BOSCH HEADLIGHTS**

#### **Right Headlight**

Vertical Adjustment — lower screw

Horizontal Adjustment — right screw

#### **Left Headlight**

Vertical Adjustment — upper screw

Horizontal Adjustment — left screw

### **HELLA HEADLIGHTS**

#### **Right Headlight**

Vertical Adjustment — lower screw

Horizontal Adjustment — upper screw

#### **Left Headlight**

Vertical Adjustment — upper screw

Horizontal Adjustment — lower screw

### **HEADLIGHT BULB REPLACEMENT**

Loosen the slotted screw at the headlight rim. Pull out the lens and reflector unit, unhook the tension spring, and pull out the socket. When replacing the bulb, make sure the new bulb is clean and that it is not loose in the socket. Do not touch the bulb with the bare hand, but use a clean cloth or paper serviette etc. instead. When a broken lens is being replaced, the reflector should not be touched or wiped over.

### **BRAKE ADJUSTMENT**

Brake adjustment should be performed by an Authorized VW Dealer. However, if an emergency arises where the brakes must be adjusted before you can reach the next repair shop, the following procedure for bleeding and adjusting

can be used: The master cylinder is accessible by lifting the inspection plate situated in the floor of the driver's compartment.

To fill up, use only VW GENUINE BRAKE FLUID.

The fluid reservoir should be kept at least  $\frac{3}{4}$  full at all times.



## BLEEDING HYDRAULIC SYSTEM

The presence of air in the hydraulic brake system will cause "spongy" brake pedal operation. The system then has to be bled as follows:

- 1 - Remove rubber cap of the bleeder valve of one wheel cylinder and attach one end of the brake bleeder hose to the valve.
- 2 - Place the opposite end of the bleeder hose in a glass container partly filled with brake fluid so that the end of the hose is submerged. The end of the hose should be located as high as possible.
- 3 - Turn the bleeder valve to the open position (1 to 2 turns).
- 4 - Pump the brake pedal several times until bubbles cease to appear in the container. Make sure that enough brake fluid remains in the fluid reservoir, since otherwise air will be sucked in.
- 5 - Keep the brake pedal in the fully depressed position until the bleeder valve is closed.
- 6 - Remove bleeder hose and replace bleeder valve rubber cap.
- 7 - Repeat the operations on the other wheels. Finally check and, if necessary, top up fluid level of master cylinder reservoir.

## ADJUSTING HYDRAULIC BRAKE

Too much free travel of the brake pedal is an indication that the clearance between brake shoes and brake drums has become too great. The amount of wear can be gauged by looking through the adjusting hole in the brake drum. The brake shoes should be relined when the visual inspection, to be carried out every 4000 km. (2400 miles), reveals excessive wear.

Remove hub caps.

The thickness of the brake linings should be not less than 2.5 mm. (.1 in.)

The brake shoes are to be adjusted as follows:

- 1 - Jack up the vehicle and turn forward the wheel to be adjusted, until the hole in the brake drum is in line with one of the adjusting nuts.
- 2 - Insert a screwdriver through the hole and turn the adjusting nut in the direction indicated by the arrows until a light drag is noted when the wheel is turned by hand.

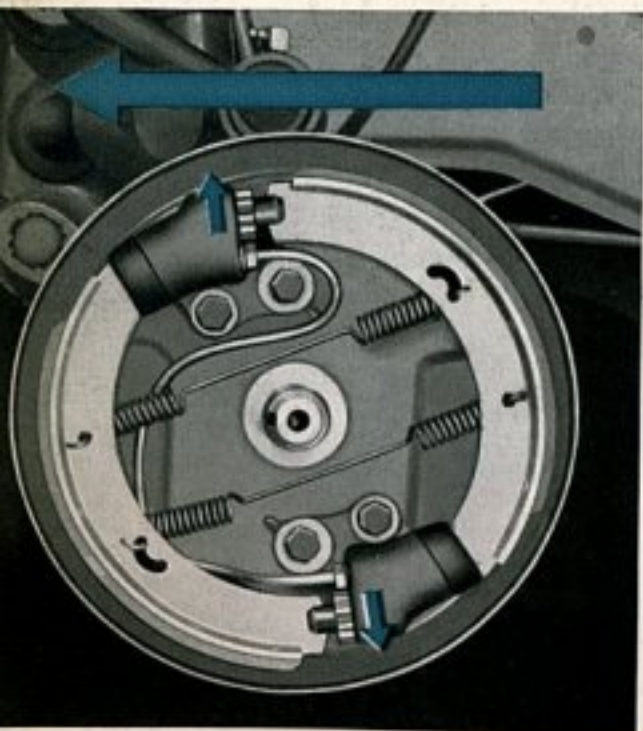

- 3 - Repeat procedure on the other adjusting nut. Note the opposite turning direction of the two nuts.
- 4 - Back off the adjusting nuts by 3 to 4 teeth until the wheel turns freely.
- 5 - Repeat the above operations on the other wheels.

When adjusting the rear wheel brakes, the hand brake must be released.

It is advisable to depress the brake pedal sharply before and after adjusting the brake shoes to ensure brake shoe centering i.e. the proper position of the shoes relative to the brake drum.

Install hub caps and make sure they are tightly seated.

### ADJUSTING HAND BRAKE

- 1 - Jack up both rear wheels.
- 2 - Unscrew cover plate underneath pedal mechanism.
- 3 - Tighten adjusting nuts on the front ends of the brake cables to a degree which will still allow the rear wheels to turn freely when the hand brake is released.
- 4 - Pull up hand brake lever by two notches and make sure both rear wheels have the same braking effect. At the fourth notch it should be impossible to turn the wheels by hand. Lock adjusting and counter nuts.

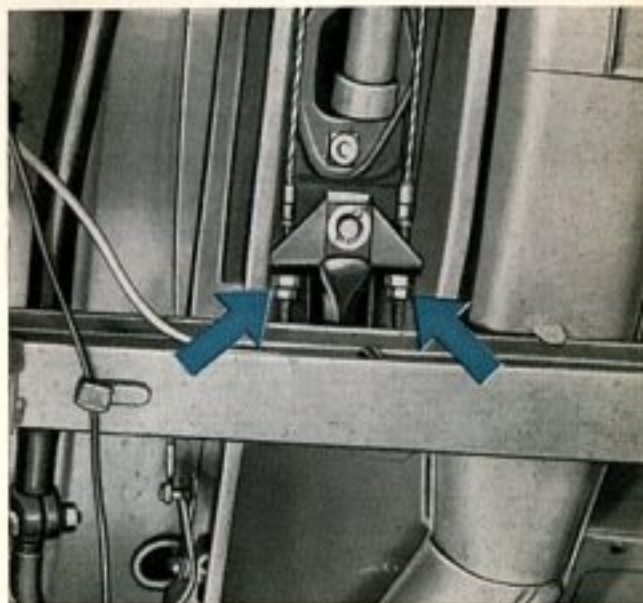

### CLUTCH PEDAL FREE-PLAY

Easy gear shifting and complete transmission of engine performance to gears and wheels can only be guaranteed if the clutch is adjusted as specified. Measured at the clutch pedal, this free-play should amount to 10—20 mm.



(0.4" — 0.8"). The clearance may be adjusted at the adjusting nut on the cable end.

- 1 - Release lock nut on the threaded cable end.
- 2 - Adjust clutch clearance by turning the adjusting nut. Depress clutch pedal several times and recheck pedal free-play.
- 3 - When the correct adjustment has been reached, hold adjusting nut in position and tighten lock nut.
- 4 - Grease clutch cable adjusting nut with Universal Grease.

### STEERING GEAR

In the straight-ahead position there should be no end play. The play within the steering mechanism should be as small as possible, but care must be taken that the front wheels resume their straight-ahead position after the vehicle has taken a turn. As special experience is needed to service this unit properly, all operations or adjustments required should only be performed by an Authorized VW Dealer.

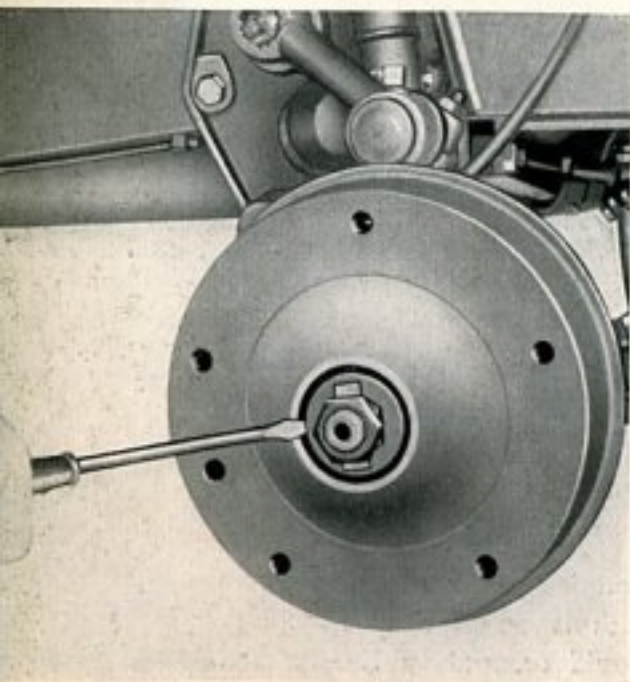

The maintenance service provides the regular adjustment of the torsion arm link pins on the front axle. After this operation, it is absolutely necessary to check the toe-in of the front wheels.

### FRONT WHEEL BEARINGS

We recommend that you refer this operation to an Authorized VW Dealer, as maladjustment may cause severe damage to the roller bearings. If circumstances require a removal of a front brake drum, the front wheel bearings are to be adjusted as outlined below:



Tighten inner nut until the thrust washer just allows to be moved laterally by a screw driver and no bearing play can be felt when rocking the brake drum. Too loose or too tight an adjustment may ruin the bearings in a short time. Finally, secure the nuts by bending down the lock plate.

## CHECKING AND ADJUSTING TORSION ARM LINK PINS

The torsion arm link pins should be checked and, if necessary, readjusted every 4000 km. (2400 miles). The front end of the car is to be raised so that the weight is taken off the wheels.

### CHECKING

Rock the wheel by hand to check for end play between torsion arm link and torsion arms. If play is present, adjust torsion arm link pins.

### ADJUSTING

- 1 - Back off pinch bolts at torsion arm eyes.
- 2 - First grease torsion arm link pins thoroughly at the same time turning the pins in both directions to remove old grease and dirt.
- 3 - Tighten the torsion arm link pins to a degree which will still allow a free movement between torsion arms and torsion arm link without perceptible play. To effect this adjustment, first fully tighten torsion arm link pins and then back them off approximately  $\frac{1}{8}$  turn. Finally retighten the pins carefully until the first resistance is felt. If no correct adjustment can be effected, the shims are worn and should be replaced by new ones in a VW Workshop.

After the torsion arm link pins have been adjusted, it is absolutely necessary to check the toe-in.

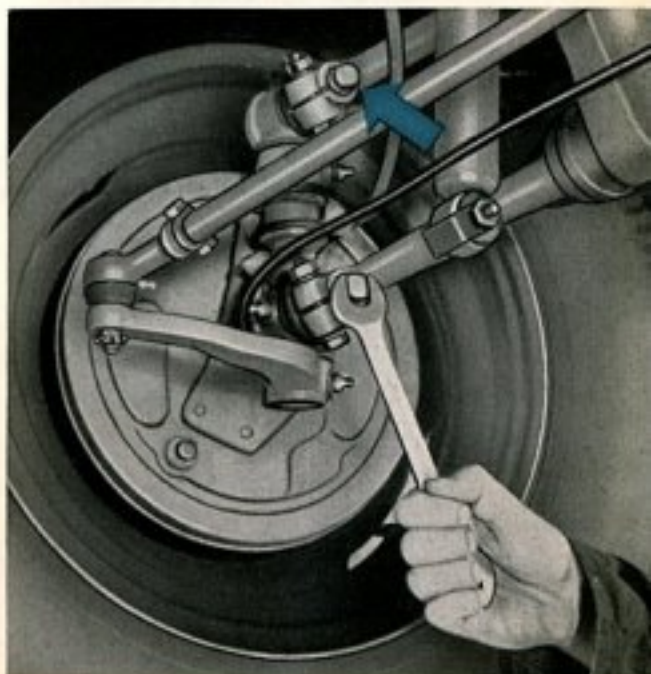

### SETTING THE TOE-IN

With the empty vehicle on the ground, front wheel toe-in should be 1—3 mm. (.04 to .12 in.) and with max. permissible gross weight it should be 2—5 mm. (.08 to .20 in.). These values can be accurately checked only with a track tester at the workshops. Inadmissible deviations will increase tire wear and impair road holding qualities.

### DOOR BUFFERS AND STRIKER PLATES

The doors of the cab should give a close fit in shut position, otherwise the striker plate requires re-adjustment. Worn striker plates are to be renewed or replaced by oversize types.

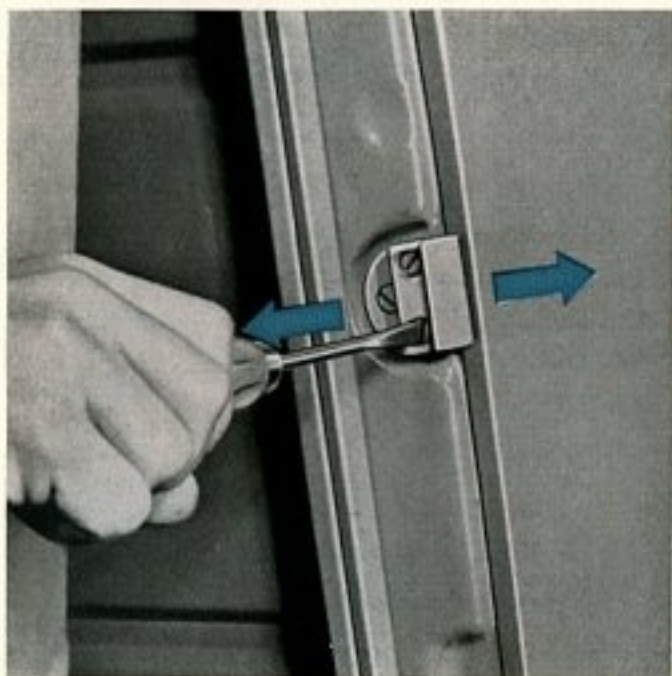



## GENERAL DESCRIPTION

### ENGINE

The engine, located in the rear of the vehicle, is mounted in a floating way on the recessed flange of the rubber-cushioned transmission. Two pairs of cylinders are horizontally opposed. Each pair has one common cylinder head made of light metal. The overhead valves are located in the cylinder head and are operated from the camshaft by means of push rods cam followers and rocker arms. The short and counter-balanced crankshaft rests in four bearings and is heat-treated at its four points of support. It drives the camshaft by means of helical gears. The connecting rods are fitted with leadbronze bearings. The pistons are made of light metal.

A downdraft carburetor produces the fuel and air mixture to supply the cylinders. The engine is equipped with battery ignition.

The oil pump of this full pressure lubrication system is driven by the camshaft and it sucks the oil from the crankcase through a strainer, from where it reaches the points of lubrication via an oil cooler. In cold weather, when the oil is of higher viscosity, an oil pressure relief valve makes it possible for the engine to be lubricated directly, that is, by avoiding the oil cooling system.

The air cooling of the engine is done by means of a fan, which is attached to the extended generator shaft and driven by a V-belt. The generator pulley is adjustable to permit adjustment of belt tension. The fan sucks in air through an opening in the fan housing, and the air cools the engine by passing through the cylinder fins. A thermostat controls and regulates the amount of cooling air and insures a proper balance of the operating and heating temperatures.

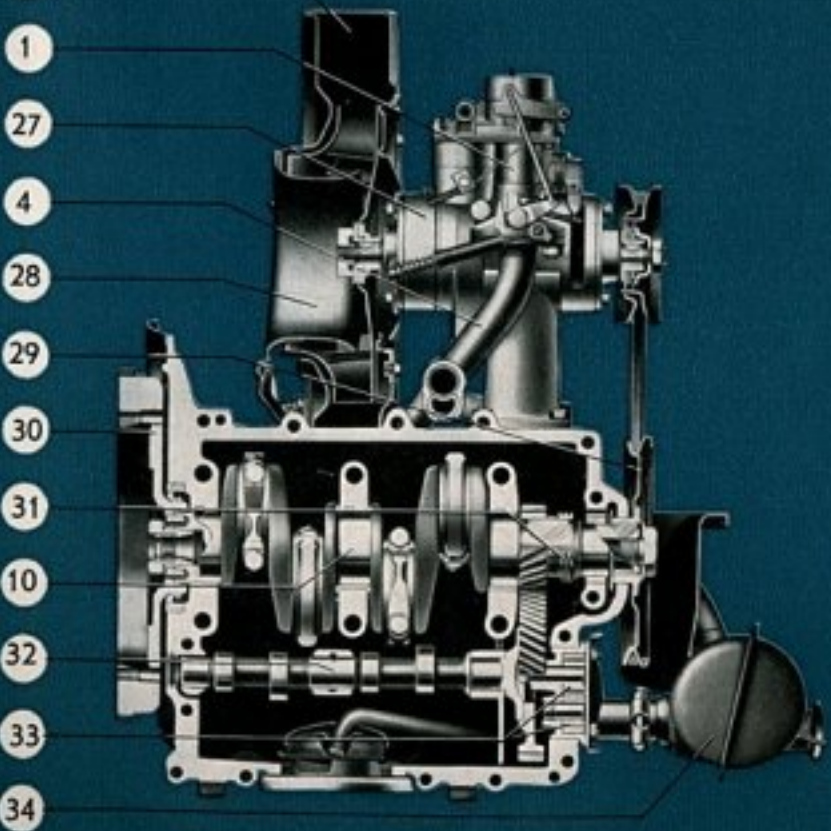
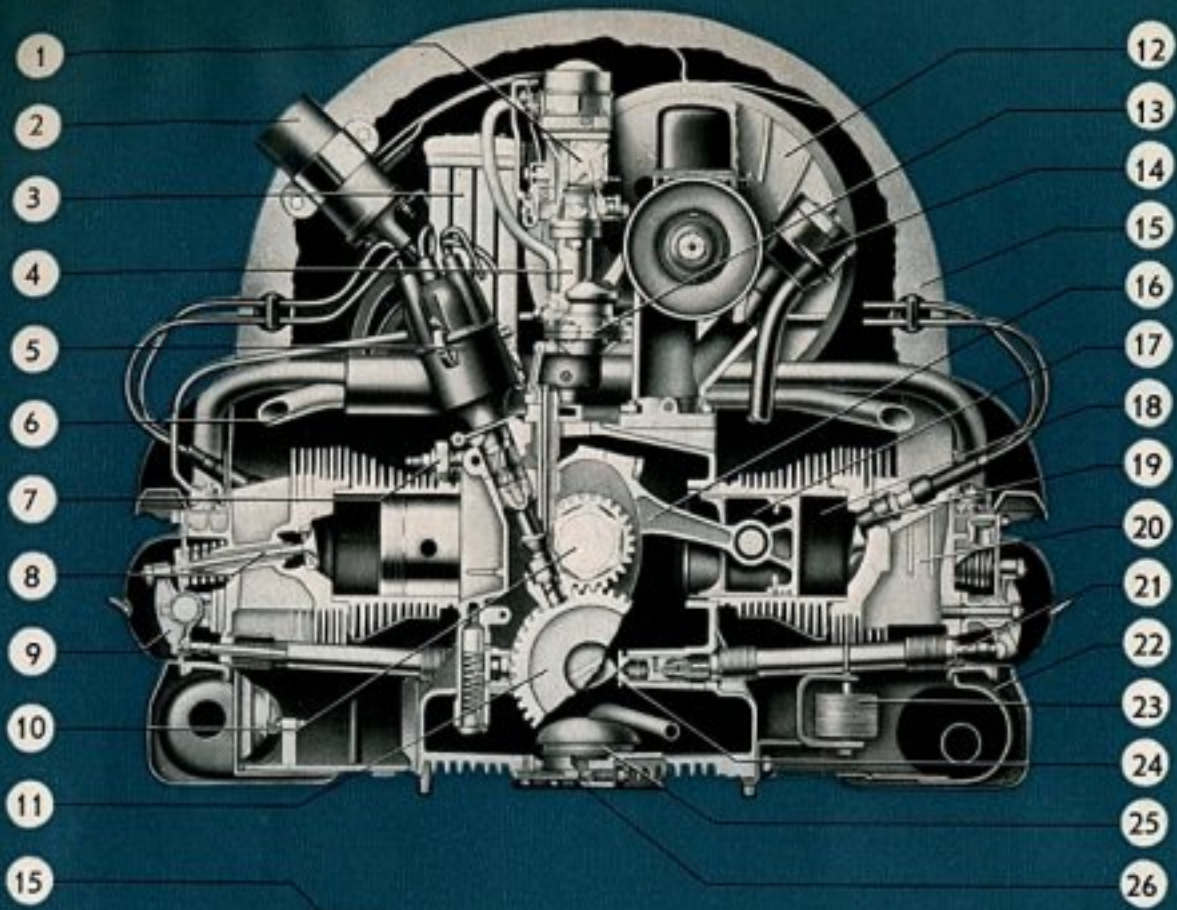

**ENGINE**

1192 c. c. B. H. P. 36 SAE

- 1 - Carburetor
- 2 - Ignition coil
- 3 - Oil cooler
- 4 - Intake manifold
- 5 - Ignition distributor
- 6 - Preheating pipe
- 7 - Oil pressure switch
- 8 - Valve
- 9 - Rocker arm
- 10 - Crankshaft
- 11 - Camshaft timing gear
- 12 - Fan
- 13 - Fuel pump
- 14 - Breather and filler assy.
- 15 - Fan housing
- 16 - Connecting rod
- 17 - Piston
- 18 - Cylinder
- 19 - Spark plug
- 20 - Cylinder head
- 21 - Valve push rod
- 22 - Heater junction box
- 23 - Thermostat
- 24 - Cam follower
- 25 - Oil strainer
- 26 - Oil drain plug
- 27 - Generator (Dynamo)
- 28 - Throttle ring
- 29 - Pulley
- 30 - Flywheel
- 31 - Distributor drive gear
- 32 - Camshaft
- 33 - Oil pump
- 34 - Muffler (Silencer)

Spark advance .....	7.5° before T. D. C.	
Breaker Point Gap .....	0.4 mm. (.016")	
Spark Plugs .....	Bosch 175 T 1	} 14 mm.
	Beru 175/14 U2i	
	Lodge H 14 or HN	
	Champion L 10 S or 85	
	AC 43 L	
	Auto-Lite AE 6 or AER 6	
	KLG F 70	
Spark Plug Gap .....	0.7 mm. (.028")	

### CLUTCH

Design .....	Single Disc, Dry
Pedal Free-Play .....	10 to 20 mm. (.4 to .8")

### TRANSMISSION

4 Forward Speeds, 1 Reverse, Gears Synchronized and Silent.

Gear Ratios .....	First: 3.80 : 1
	Second: 2.06 : 1
	Third: 1.30 : 1
	Top: 0.89 : 1
	Reverse: 3.88 : 1

### REAR AXLE

Power is transmitted through a helically-cut drive pinion and ring gear, via two swinging axles and spur wheel reduction gears to the rear wheels.

Ratio .....

Oil Capacity of Transmission and

Rear Axle .....	Metric — 3 Liters
	U. S. — 6.3 Pints
	Imp. — 5.3 Pints

### REAR WHEEL REDUCTION GEARS

Ratio .....

Oil Capacity of Reduction Gear Cases

Metric — 0.25 Liter each
U. S. — 0.53 Pint
Imp. — 0.44 Pint

### CHASSIS

Suspension, Front .....	Two Torsion Bars
Suspension, Rear .....	Two Round Torsion Bar Springs
Shock Absorbers .....	Double Acting Telescopic Type, Front and Rear
Steering .....	Ross cam and lever steering gear with rolling stud contact and hydraulic steering damper
Turns of Steering Wheel, Lock to Lock	2.8
Turning Circle .....	about 12 Meters (39 Ft.)

## **TRANSMISSION AND FINAL DRIVE**

Power from the engine is transmitted to the gears via a single-disc dry clutch. The transmission provides four speeds forward and one reverse. All models are equipped with a synchromesh transmission. The gears are helically cut to provide silent operation. The drive pinion and the ring gear of the rear axle are cut spirally. The two rear axle shafts are flexibly supported in the differential housing. Spur wheel reduction gears are provided on the outer ends of the rear axle tubes.

## **AXLES AND STEERING**

The front axle consists of two rigidly joined tubes containing the torsion springs and the suspension arms. The front wheels are sprung independently. The suspension arms form parallelograms assuring proper steering and suspension geometry under all driving conditions. Stops with rubber buffers are provided to prevent excessive rebound.

The rear axle is of the swing half-axle type. The rear wheels are also independently sprung by means of adjustable round steel torsion bars. Double acting hydraulic shock absorbers of the telescope type in front and rear prevent rebound.

The foot brake, which operates on all four wheels, is of the hydraulic type. The hand brake operates on the rear wheels through cables.

The steering gear, which is of a worm and cam follower type, actuates the steering arms of the independent suspension by a draglink and a divided tie rod.

## **BODY**

The body is of a self-supporting, all-steel design, provided with a strengthening frame to support the axles. The position of the load space within the wheelbase insures an even distribution of the load on all four wheels, no matter how the load is placed. The load space is accessible through a double-wing door from the side and through a hinged rear panel. The tarpaulin of the Pick-Up as well as the bows which are fastened to the platform by means of a few screws can easily be removed and replaced. The driver's compartment, for 3 persons, offers exceptional driving visibility. Adequate ventilation is insured by ventilator wings and sliding windows in addition to a fresh air regulator above the windshield.

## **HEATING SYSTEM**

Heated air, which is taken from the air flow warmed up by the engine, is guided through the middle of the vehicle into the driver's compartment by one duct in the floor and two defroster nozzles at the windscreen. The passenger compartment of the Micro Bus is heated by additional vents under the rear seats. The heating system can be turned on and off from the driver's seat.

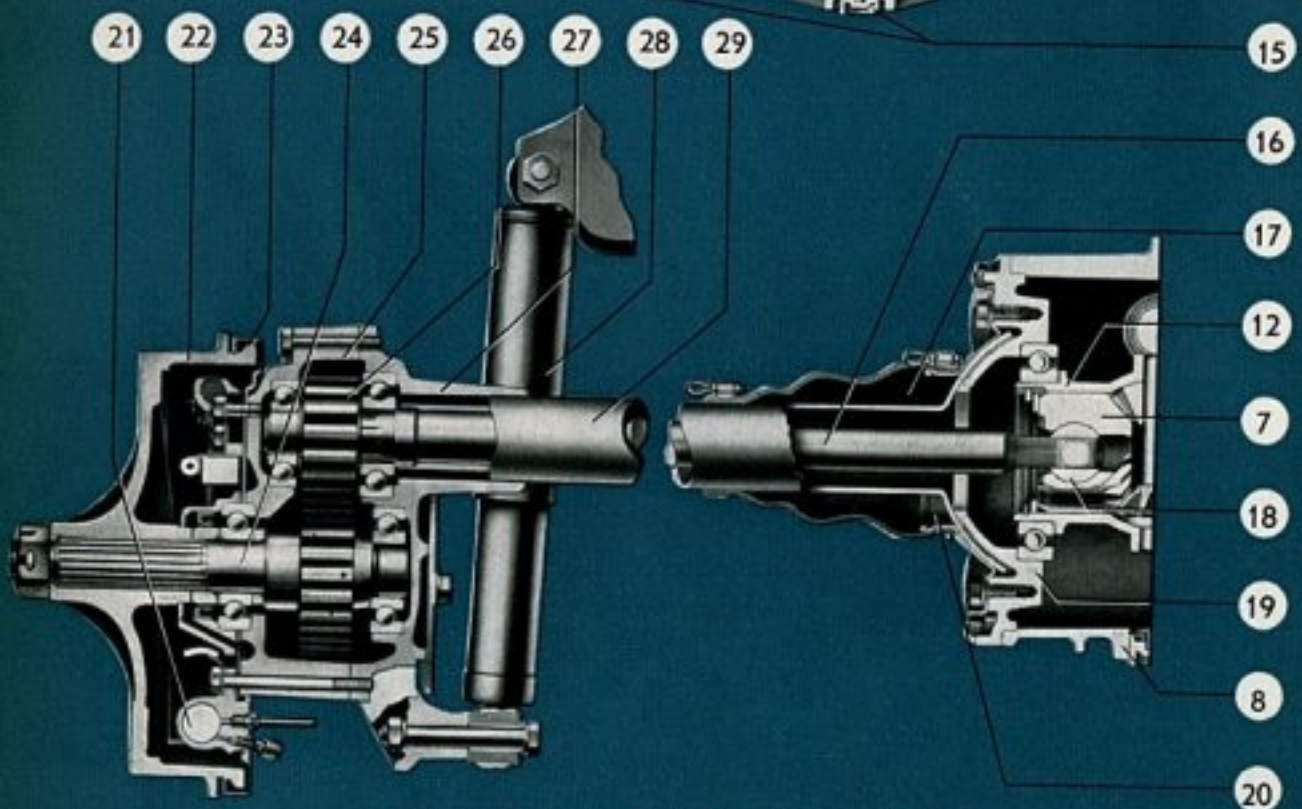
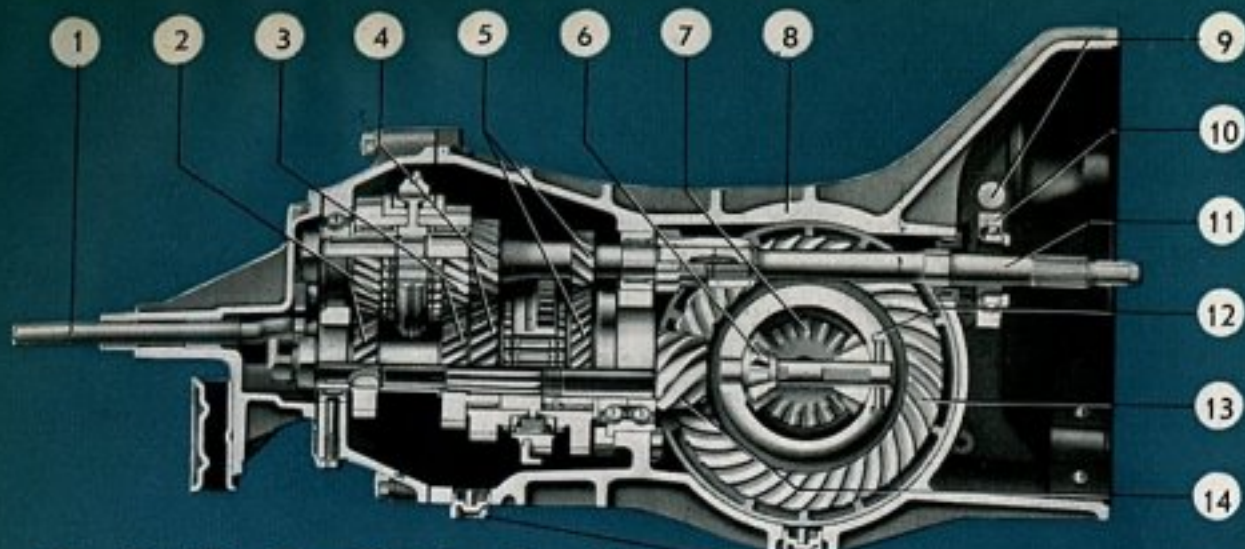

### REAR AXLE AND TRANSMISSION

- |                             |                                 |   |
|-----------------------------|---------------------------------|---|
| 1 - Selector shaft, inner   | 13 - Ring gear<br>(Crown wheel) | 21 - Wheel brake cylinder               |
| 2 - 4th gear                | 14 - Drive pinion               | 22 - Brake drum                         |
| 3 - 3rd gear                | 15 - Magnetic<br>oil drain plug | 23 - Brake back plate                   |
| 4 - 2nd gear                | 16 - Rear axle shaft            | 24 - Reduction driven gear<br>and shaft |
| 5 - 1st gear                | 17 - Dust sleeve                | 25 - Reduction gear case<br>cover       |
| 6 - Differential pinion     | 18 - Fulcrum plate              | 26 - Reduction drive gear               |
| 7 - Side gear               | 19 - Final drive cover          | 27 - Reduction gear case                |
| 8 - Transmission case       | 20 - Rear axle tube<br>retainer | 28 - Telescopic shock<br>absorber       |
| 9 - Clutch operating shaft  |                                 | 29 - Rear axle tube                     |
| 10 - Clutch release bearing |                                 |   |
| 11 - Main drive shaft       |                                 |   |
| 12 - Differential housing   |                                 |   |

Foot Brake .....	Hydraulic Brake, Operating on all 4 Wheels
Hand Brake .....	Mechanical, Operating on Rear Wheels
Wheels .....	4½ K × 15, Drop-Center Type
Tires .....	6.40—15
Inflation Pressure .....	Front: 2.0 kg./sq. cm. (28 lbs./Sq. In.) Rear: 2.3 kg./sq. cm. (33 lbs./Sq. In.)
Ambulance .....	Front and Rear: 1.8 atm. (26 lbs./Sq. In.)
Wheel Base .....	2400 mm. (94.5 In.)
Track (Tread) .....	Front: 1370 mm. (53.9 In.)
Camber of Front Wheels .....	Rear: 1360 mm. (53.5 In.)
(in unloaded condition) .....	0° 40'
Toe-in (Vehicle in unloaded condition) .....	0 ± 1 mm. (.04 In.)
(Vehicle in fully loaded condit.) .....	2—5 mm. (.08—.20 In.)
Castor .....	0°

## DIMENSIONS AND WEIGHTS

	Delivery Van Micro Bus Kombi	Micro Bus De Luxe	Pick-Up without tarpaulin	Pick-Up with tarpaulin	Ambulance
Length .....	4280 mm. (168.5")	4300 mm. (169.3")	4290 mm. (168.9")	4290 mm. (168.9")	4280 mm. (168.5")
(with bumperguards)	4290 mm. (168.9")	—	4300 mm. (169.3")	4300 mm. (169.3")	4300 mm. (169.3")
Width .....	1750 mm. (68.9")	1800 mm. (70.9")	1750 mm. (68.9")	1750 mm. (68.9")	1750 mm. (68.9")
Height .....	1940 mm. (76.4")	1940 mm. (76.4")	1920 mm. (75.6")	2210 mm. (87.0")	1940 mm. (76.4")
Ground Clearance .....	240 mm. (9.4")	240 mm. (9.4")	240 mm. (9.4")	240 mm. (9.4")	240 mm. (9.4")

### Delivery Van and Kombi

Load Space		
Mean Length .....	2700 mm. (106.3")	} approx. 4.8 cu. m. (170 cu. ft.)
Mean Width .....	1500 mm. ( 59.1")	
Mean Height .....	1350 mm. ( 53.1")	

### Luggage Compartment in Micro Bus

Mean Length .....	700 mm. ( 27.6")	} approx. .8 cu. m. (28 cu. ft.)
Mean Width .....	1450 mm. ( 57.1")	
Mean Height .....	800 mm. ( 31.5")	

### Pick-Up

Loading Area		
Length .....	2600 mm. (102.4")	} approx. 4.2 Sq. m. (45 Sq. ft.)
Width .....	1570 mm. ( 61.8")	
Height of Drop Sides .....	375 mm. ( 14.8")	



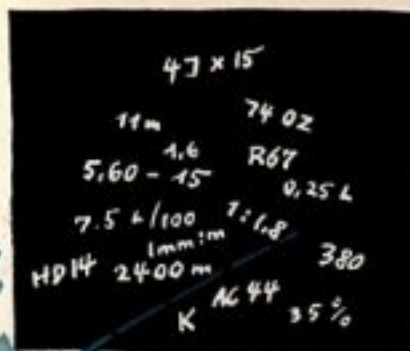

## ENGINE

# TECHNICAL DATA

Design .....	4 Cylinder, 4 Stroke, Carburetor-Type, in Rear of Vehicle
Arrangement of Cylinders .....	Horizontally Opposed
Bore .....	77 mm. (3.031")
Stroke .....	64 mm. (2.520")
Capacity .....	1192 c. c. (72.740 cu. in.)
Compression Ratio .....	6.6
Valves .....	O. H. Type
Valve Clearance .....	Intake 0.10 mm. (.004")
	Exhaust 0.10 mm. (.004")
	} to be adjusted when engine is cold
Brake Horsepower (SAE) .....	36 HP. at 3700 R. P. M.
Lubrication .....	Full Pressure (Gear Pump with Oil Cooler)
Oil Capacity .....	Metric — 2.5 Liters U. S. — 5.3 Pints Imp. — 4.4 Pints
Fuel Pump .....	Mechanical Type
Carburetor .....	Downdraft Type Solex 28 PCI
Cooling System .....	Air Cooling by Fan, Thermostat-controlled
Battery .....	6 Volts, 77 Ampere Hours
Starter .....	Electric, 6 Volts, .5 HP.
Generator .....	6 Volts, 180 Watts at 2500 R. P. M., with Voltage Regulator
Ignition Distributor .....	Centrifugal spark advance
Firing Order .....	1—4—3—2

Height of Tarpaulin above Loading Area .....	1200 mm. (740.2")	
Height of platform (unladen) above ground .....	980 mm. ( 38.6")	
Locker		
Length .....	1200 mm. (47.2")	} approx. 1.9 Sq. m. (20 Sq. ft.)
Width .....	1600 mm. (63.0")	
Height .....	340 mm. (13.4")	
Loading Space .....	.65 cu. m. (23 cu. ft.)	

WEIGHT IN Kg. (lbs.)	Unladen Weight (Ready for operation)	Payload	Max. perm. Gross Weight	Number of Seats
Delivery Van .....	1020*	830	1850	3
Pick-Up without tarpaulin .....	2249*	1830	4079	
	1050*	800	1850	3
Pick-Up with tarpaulin .....	2315*	1764	4079	
	1085*	765	1850	3
	2392*	1687	4079	
Kombi .....	1040*	810	1850	3
	2293*	1786	4079	
Micro Bus .....	1110	740	1850	8
	2447	1632	4079	
Ambulance .....	1210	640	1850	7
	2668	1411	4079	

\* including driver

Permissible Axle Loads in kg. (lbs.) ...	Front 950 (2094)	Rear 1000 (2205)
--	---------------------	---------------------

### PERFORMANCE

Maximum Speed .....	90 k. p. h. (56 m. p. h.)
Pick-Up with tarpaulin .....	85 k. p. h. (53 m. p. h.)
Climbing Ability First Speed .....	25 %
Second Speed .....	13 %
Third Speed .....	7.5%
Top Speed .....	4 %

### REFILL REQUIREMENTS

Fuel Tank Capacity .....	40 Liters (of these, 5 liters as reserve)
	U. S. — 10.6 Gallons (1.3 gall. as reserve)
	Imp. — 8.8 Gallons (1.1 gall. as reserve)
Engine .....	2.5 Liters (5.3 U. S. Pints, 4.4 Imp. Pints)
Transmission and Rear Axle ...	2 Liters (4.2 U. S. Pints, 3.5 Imp. Pints)
Reduction Gear Cases .....	0.25 Liter each (0.53 U. S. Pints, 0.44 Imp. Pints)
Steering Gear .....	0.25 Liter (0.53 U. S. Pints, 0.44 Imp. Pints)
Brake System .....	0.3 Liter (0.63 U. S. Pints, 0.53 Imp. Pints)

## FUEL CONSUMPTION

Average Consumption According to DIN 70 030

Delivery Van, Micro Bus, Kombi ..	Metric — 9.5 Liters per 100 km.
	U. S. — 24.5 Miles per Gallon
	Imp. — 29.5 Miles per Gallon
Pick-Up without tarpaulin .....	Metric — 10 Liters per 100 km.
	U. S. — 23.5 Miles per Gallon
	Imp. — 28 Miles per Gallon
Pick-Up with tarpaulin .....	Metric — 10.4 Liters per 100 km.
	U. S. — 22.5 Miles per Gallon
	Imp. — 27 Miles per Gallon
Fuel .....	76 octane number (Res. F 1)
Oil Consumption .....	Approx. 0.5—1.4 Liter per 1000 km.
	1.7—4.8 U. S. Pints per 1000 Miles
	1.4—4.0 Imp. Pints per 1000 Miles.

The measured average consumption is the actual consumption plus 10%, determined with vehicles at half the permissible payload at a continuous  $\frac{3}{4}$  of maximum speed (67.5 k. p. h. 42 m. p. h.) on level road.

## BULB-CHART

V = Volts, W = Watts

Light Description	Designation of Bulb (according to German standard DIN 72 601)	VW Part Number
Headlights .....	B 6 V 35/35 W	N 17 701 1
Parking lights .....	H 6 V 2 W	N 17 720 1
Tail and stop lights .....	S 6 V 5/20 W	N 17 736 1
License plate light .....	G 6 V 5 W	N 17 718 1
Instrument light .....	J 6 V 1.2 W	N 17 722 1
Dome light .....	L 6 V 5 W	N 17 725 1
Direction indicator (semaphore type) .....	M 6 V 3 W	N 17 726 1
<b>USA Version</b>		
Indicator lights, front (flashing type) .....	R 6 V 20 W	N 17 730 1
<b>Micro Bus De Luxe</b>		
Clock light .....	J 6 V 1.2 W	N 17 722 1
<b>Ambulance</b>		
Back-up light .....	E 6 V 25 W	N 17 710 1
Spot light .....	E 6 V 25 W	N 17 710 1
<b>Ambulance identification light</b>		
(German type) .....	F 6 V 15 W	N 17 716 1
Fuel gauge light .....	J 6 V 1.2 W	N 17 722 1

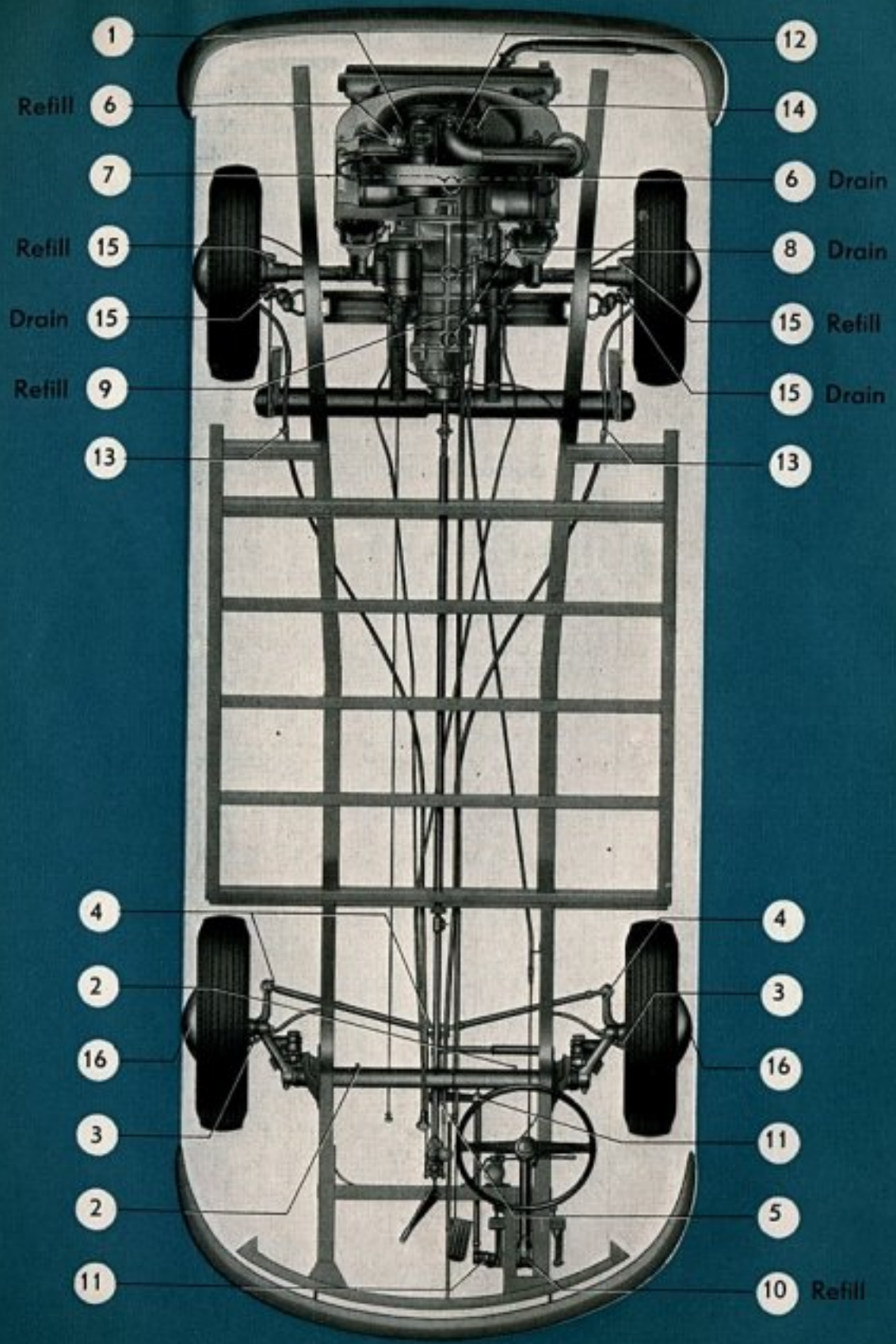

# LUBRICATION CHART

km./Miles 500 300 2000 1200 21 4000 2400	No.	Lubrication points	Lubricant	Every	
	1	Engine: check oil level	M	<b>2000 km. 1200 Miles</b>	
	2	Front axle tubes	F		
	3	King pins	F		
	4	Tie rod ends	F		
	5	Steering arms Door hinges	F M		
	6	Engine: change oil	M	<b>4000 km. 2400 Miles</b>	
	7	Engine: clean oil strainer Clean magnetic oil drain plugs			
	9	Transmission: check oil level	G		
	10	Steering gear: check oil level	G		
	11	Draglink	F		
	12	Carburetor controls	M		
	13	Brake cables	F		
	14	Breaker arm fiber block in ignition distributor Door and lid locks	F F		
	8	Transmission: change oil	G	<b>12 000 km. 7200 Miles</b>	
	15	Reduction gear case: change oil	G		
	14	Felt in ignition distributor cam	M		
	16	Front wheel bearings	W	<b>24 000 km. 14 400 Miles</b>	

## LUBRICANTS

Lubricant	Lubrication points		Specifications			
			Temperature °C	°F		
Engine oil (Trade-mark HD oil for spark ignition engines)	Engine, oil bath air cleaner door hinges, carburetor controls,  felt in ignition distributor cam	M	above	+30	+86	SAE 30
			up to	0	+32	SAE 20 or SAE 20 w
			below	+30	+86	
			below	0	+32	SAE 10 w
			below	-25	-13	SAE 5 w
Transmission oil	Transmission case, reduction gear cases	G	above	0	+32	SAE 90
	Steering gear case	G	below	0	+32	SAE 80
Universal grease	Front axle, tie rod ends, steering arms, drag link, Brake cables, Ignition distributor cams, Door and lid locks	F	<b>Anti-freeze, water-repellent grease</b>			
Special grease	Front wheel bearings	W	Antifriction bearing grease			

# MAINTENANCE CHART

km. Miles	AI		Operation	Every
	500 300	2000 1200		
			Check air cleaner, clean if necessary	<b>4000 km. 2400 Miles</b>
			Check and adjust fan belt	
			Clean fuel pump filter Check carburetor adjustment	
			Check breaker points and ignition timing	
			Check and adjust valve clearance	
			Test battery	
			Check operation of lights, signal horn and instruments	
			Check generator	
			Check and set spark plugs, check compression	
			Check front wheel bearings, torsion arm link pins, steering, and toe-in	
			Check tire pressure and tightness of wheel bolts Rotate wheels from 4000 km. (2400 miles) onwards	
			Test brakes and check brake fluid level Check thickness of brake linings through inspection hole	
			Check tightness and effect of shock absorbers	
			Check clutch pedal free-play	
			Check door rubber buffers and striker plates	
			Check automatic cooling air regulation	<b>12 000 km. 7200 Miles</b>
			Inspect transmission and engine for oil leaks	
			Engine, especially exhaust system, carburetor, intake manifold and fuel pump Chassis, body, axles, steering system	
			} Check tightness of nuts and bolts	

# INDEX

	Page		Page
Accelerating — correct and wrong	22	Driving the VW Transporter	15
Accelerator pedal	7	Driving down-hill	17
— accelerating	22	Economy	22
Accessories	III	Engine — compression ratio	69
Ambulance — specifications	71/72	— description	65
Ash receiver	20	— design	69
Axle loads	72	— lubrication (oil change)	29/30
Battery — maintenance	56	— oil change in winter	27
— care in winter	28	— oil level	10
Body — description	67	— oil strainer	30/31
Brakes — adjusting	58	— sectional view	66
— application	17	— technical data	69
— bleeding	59	— type of oil	11/30
— care in winter	28	Engine compartment lid	
— checking	13	— releasing check mechanism	10
— description	67	Fan belt — adjusting	46
Breaking-in (running-in) period	21	— checking tension	11
Camber of front wheels	71	Foot brake — adjusting	60
Carburetor — adjusting	49	— description	67
— type	69	Fresh air regulator	
Care of the VW Transporter	41	— description and operation	18/19
Castor of front wheels	71	Front axle — description	67
Chassis — care in winter	27	— lubrication	35
Chassis number	8	— technical data	70
Choke control knob	7	Front wheel bearings — adjusting	62
— application	14	— lubrication	36
Chromium-plated parts — care	43	Fuel consumption	73
Climbing ability	72	Fuel pump — cleaning	48
Clutch — design	70	Fuel tank — capacity	11
— pedal	7	— filler	11
— pedal free-play	70	— reserve	12
Controls and instruments	5	Fuel tap positions	12
Cold weather hints	26	Fuse box	55
Cooling of engine	65	Fuses — exchanging	54
Delivery Van — specifications	71	Gear lever	7
Dimensions — inside and outside	71	— lubrication	36
Dimmer switch — headlight	7	Generator	66
Direction indicators switch	7	Ground clearance	71
Doors — lubrication points	37		

	Page		Page
Hand brake — adjusting .....	61	Polishing the paintwork .....	42
— description .....	67	Practical driving .....	21
Headlights — aiming .....	57	Ratios — rear axle .....	70
— changing bulb ....	58	— transmission .....	70
Heating — description .....	67	Rear axle — description .....	67
— operation .....	26	— lubrication .....	32
Horn button .....	7	— reduction gears ....	70
Identification plate .....	8	— sectional view .....	68
Idling — checking and adjusting ..	49	— technical data .....	70
Ignition — breaker point gap ....	52	— transmission of power	70
— distributor .....	69	Rear view mirror .....	24
— firing order .....	69	R.P.M. of engine — permissible ..	69
— timing .....	52	Reverse gear .....	16
Instrument panel light .....	13	Safety in traffic .....	24
Interior light .....	18	Sectional view with explanations ..	68
Jack — application .....	39	Shifting gears .....	16
Key — doors and ignition .....	5	Shifting to reverse .....	16
Kombi — specifications .....	71	Shock absorbers — design .....	70
License plate light		Spare wheel .....	39
— replacing bulb .....	54	Spark plug — checking and cleaning	51
Light switch — positions .....	13	— gap .....	51
Lubricants .....	75	Speedometer .....	5
Lubrication .....	29	Speed ranges .....	21
Lubrication Chart .....	75	Spots — removal .....	42
Lubrication points .....	74	Starting — danger in closed rooms	15
Maintenance Chart .....	76	— in winter .....	14
Maximum performance .....	72	— with engine cold .....	14
Maximum speed .....	72	— with engine hot .....	15
Micro Bus — specifications .....	71	Starting motor .....	69
Non-skid chains .....	28	Steering — adjusting .....	62
Oil consumption .....	73	— description .....	67
Oil level — engine .....	10	— maintenance .....	62
— steering gear .....	34	— type .....	70
— transmission .....	33	Steering wheel .....	7
Paintwork — preservation .....	42	Stop light — bulb replacement ....	54
Parking your Transporter .....	25	— checking .....	13
Passing other cars .....	24	Stopping the vehicle — generally .	13
Pick-Up — specifications .....	71	— temporarily	24
		Sun roof — cleaning .....	43
		— operation .....	19
		Suspension — front .....	70
		— rear .....	70



## **VW Transporter, Sectioned**

- 1 - Pedals
- 2 - Steering gear
- 3 - Hand brake lever
- 4 - Brake master cylinder
- 5 - Gear lever
- 6 - Front axle
- 7 - Front shock absorber
- 8 - Spare tire and wheel
- 9 - Jack socket
- 10 - Fresh air regulator
- 11 - Heated air duct
- 12 - Side member
- 13 - Torsion bar seat
- 14 - Fuel tank
- 15 - Transmission
- 16 - Rear shock absorber
- 17 - Reduction gears
- 18 - Air cleaner
- 19 - Carburetor
- 20 - Distributor
- 21 - Generator
- 22 - Muffler (Silencer)
- 23 - Battery

	Page		Page
Technical data .....	69	Valves — adjusting .....	50
Tires — inflation pressure .....	13	— arrangement .....	69
— maintenance .....	38	— clearance .....	50/69
— M + S .....	28	Vent wing .....	7
— size .....	71	<b>Warning lights</b>	
— wear .....	38	— direction indicator .....	5/23
Toe-in of front wheels .....	71	— generator and cooling ....	5/23
Toe-in, setting of .....	64	— headlight .....	5/23
Tools and accessories .....	III	— oil pressure .....	5/23
Track (tread) .....	71	— replacing bulbs .....	56
Transmission — description .....	67	Washing your vehicle .....	41
— oil change and		Weights .....	72
capacity .....	33	Wheel base .....	71
— sectional view ....	68	Wheels — balancing .....	39
— technical data ....	70	— changing .....	39
Turning circle .....	70	— rim size .....	71
Type of fuel .....	12	Windows .....	18
<b>Upholstery — care</b> .....	43	Windshield — cleaning .....	44
		Windshield wiper switch .....	7





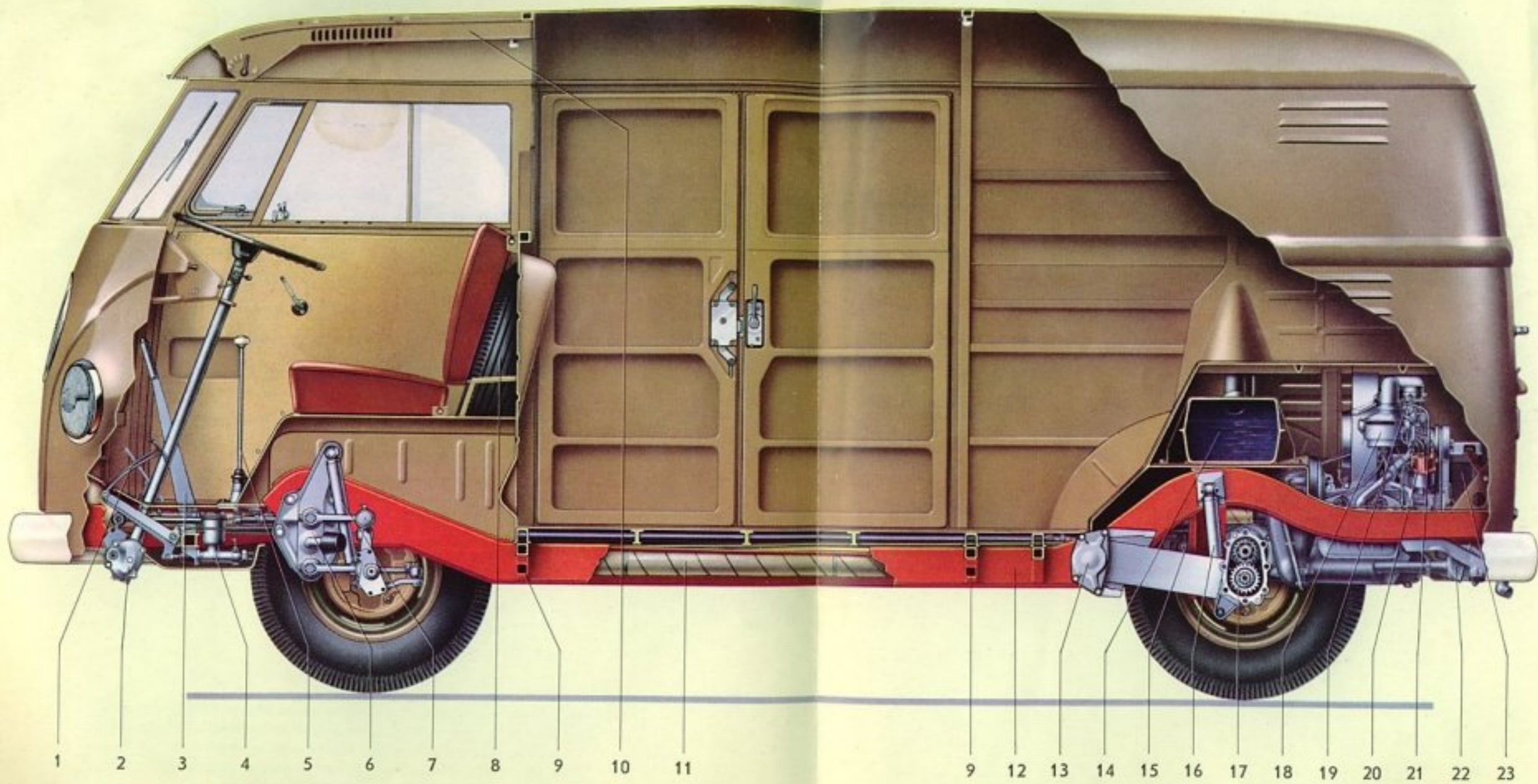



## **Tools and Accessories**

- 1 Fan Belt
- 1 Tool Bag
- 1 Starting Handle
- 1 Spare Wheel
- 1 Jack
- 1 Hub Cap Removal Tool
- 1 Square Key
- 1 Combination Pliers
- 1 Screw Driver 0.8 mm.
- 1 Screw Driver 0.5 mm.
- 1 Socket Wrench 14 mm.
- 1 Socket Wrench for Spark Plug, Wheel Bolt,  
Pulley and Jack
- 1 Open End Wrench 8/12 mm.
- 1 Tommy Bar (Mandrel) for Socket Wrench
- 1 VW Service Booklet

The VOLKSWAGENWERK GMBH reserves the right to make any changes in or improvements on its products without imposing any liability or obligation upon itself to install them on its products previously manufactured.  
Reproduction or translation in part or in full permitted only with the written consent of Volkswagenwerk.

